

The Wireless World

THE PRACTICAL RADIO JOURNAL
23rd Year of Publication

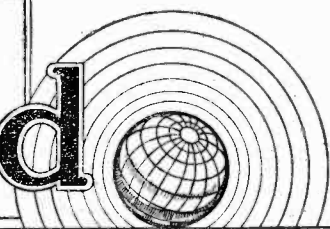
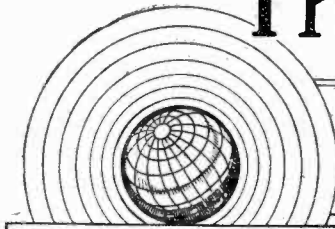

No. 727.

FRIDAY, AUGUST 4TH, 1933.

VOL. XXXIII. No. 5.

Proprietors: ILIFFE & SONS LTD.

Editor:

HUGH S. POCOCK.

Editorial,

Advertising and Publishing Offices:
DORSET HOUSE, STAMFORD STREET,
LONDON, S.E.1.

Telephone: Hop 3333 (50 lines).
Telegrams: "Ethaworld, Watloo, London."

COVENTRY: Hertford Street.

Telegrams: "Cyclist, Coventry." Telephone: 5210 Coventry.

BIRMINGHAM:

Guildhall Buildings, Navigation Street, 2.

Telegrams: "Autopress, Birmingham." Telephone: 2970 Midland (3 lines).

MANCHESTER: 260, Deansgate, 3.

Telegrams: "Iliffe, Manchester." Telephone: Blackfriars 4412 (4 lines).

GLASGOW: 26B, Renfield Street, C.2.

Telegrams: "Iliffe, Glasgow." Telephone: Central 4857.

PUBLISHED WEEKLY. ENTERED AS SECOND CLASS MATTER AT NEW YORK, N.Y.

Subscription Rates:

Home, £1 1s. 8d.; Canada, £1 1s. 8d.; other countries abroad, £1 3s. 10d. per annum.

As many of the circuits and apparatus described in these pages are covered by patents, readers are advised, before making use of them, to satisfy themselves that they would not be infringing patents.

CONTENTS

	Page
PROGRAMMES FROM ABROAD, pp. I—XXIV	
Editorial Comment	67
Simultaneous Broadcasting	68
Practical Hints and Tips	71
Conquering the Atlantic	72
Why the Double-Hump?	74
Unbiased	77
Ferranti "Gloria" Consolette	78
Letters to the Editor	79
News of the Week	81
Laboratory Tests on New Products	82
Broadcast Brevities	83
Readers' Problems	84

EDITORIAL COMMENT

Electricity and Wireless

Remove the Restrictions

AS readers are now well aware, *The Wireless World* over a long period has urged the necessity for legislation as the only effective means of controlling and eliminating electrical interference with wireless reception. We recommended that it was essential that the various electrical bodies themselves should be in agreement as far as possible on the form which this legislation should take, and *The Wireless World* made a direct invitation to the Institution of Electrical Engineers to appoint a Committee of the electricity interests to investigate the whole problem and to help in the framing of legislation which, whilst providing a satisfactory basis for the elimination of interference, would, at the same time, not be unreasonable in its requirements from the manufacturers and installers of electrical equipment.

The Institution of Electrical Engineers promptly responded to the invitation, the Committee has been set up, and is now sitting.

It has been put to us by some correspondents that the manufacturers of electrical apparatus, as the offenders, ought to have been dictated to in the matter and that the Committee to decide what steps should be taken ought to have been composed mainly of wireless, rather than electrical, interests.

We cannot agree with this point of view. So long as the Committee now sitting realises, as we are sure is the case, that legislation has got to be, we feel confident that they will not be influenced by their own immediate interests to put forward inadequate recommendations. The electrical interests are now sufficiently well aware that wireless is far too much a national

concern to be treated lightly. Again, the popularity of wireless is a most valuable asset to the electrical industry. Thousands of consumers have changed their homes in order to be in a district supplied by electricity, primarily influenced by their desire to have an electrically operated wireless set, and thousands more have been influenced in their final decision to have electricity installed for the same reason. Once there is electricity in the home almost every branch of the electrical industry profits as a result of its extended use for other domestic requirements.

Valves or Stages?

The New Designation

WE congratulate Messrs. E. K. Cole on being the first wireless manufacturers to discontinue the practice of designating their receivers in terms of the number of valves in the set. This firm has now announced that, commencing with this season, they will drop the misleading title of "so many valves" and will in future indicate their sets by the number of "stages," a stage being regarded as equivalent to a single valve in the days before the "complications" of multiple valves set in.

The change over to stages will also be facilitated by the new comprehensive licence now available to manufacturers from the "patents pool." Royalties will in future be based on the number of "stages" instead of "valveholders" as heretofore, the stage being here defined as an anode to cathode electron stream. Valves employed as rectifiers will no longer be regarded as a valve stage for the purposes of this calculation, so that there will be no excuse in the future for manufacturers to describe as a five-valve set one which employs only four stages and a valve rectifier.

SIMULTANEOUS BROADCASTING

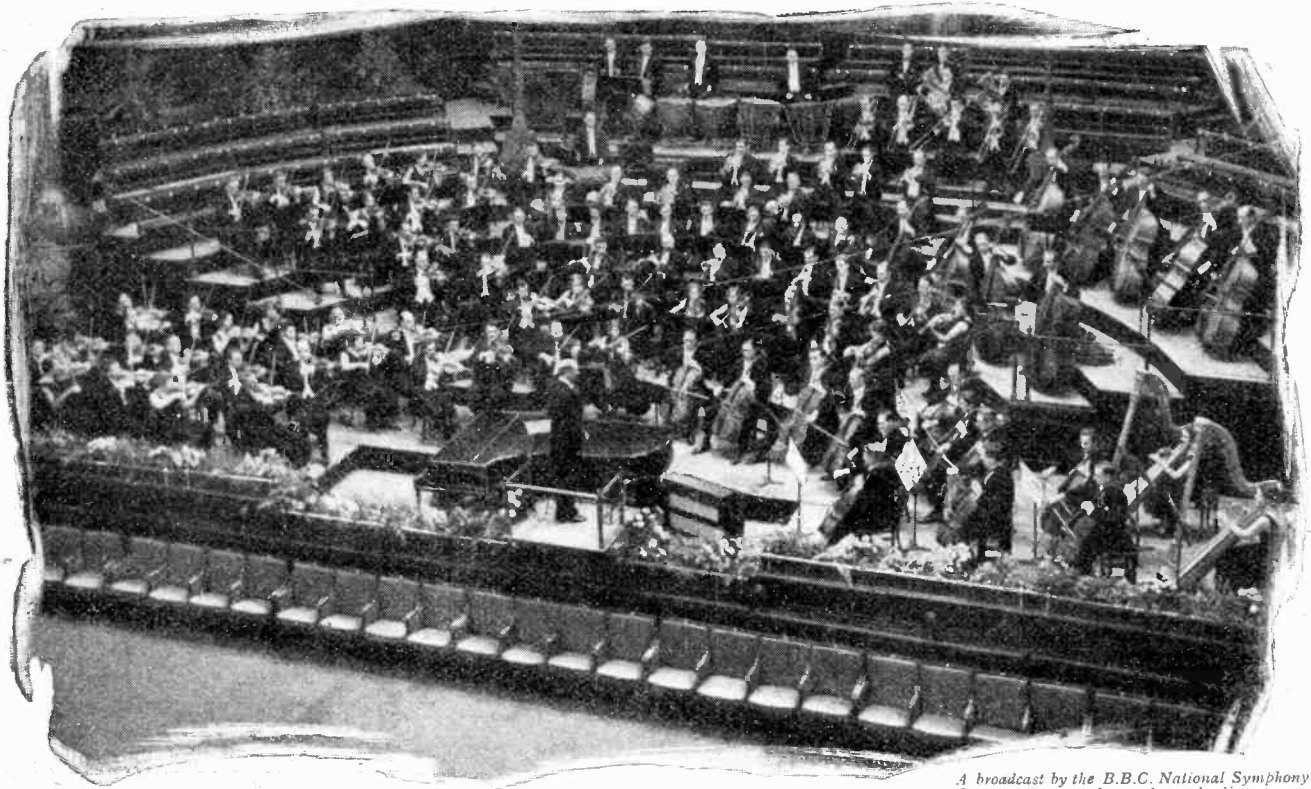

A broadcast by the B.B.C. National Symphony Orchestra, seen above, demands line transmission of the highest quality.

The Technique of a Regional Network

That "wireless" uses wires is one of the oldest paradoxes connected with the radio art, yet many listeners would be puzzled if asked to describe the workings of the vast network of wires which compose a national broadcasting system. This article explains in simple terms the general principles on which "S.B." is conducted and how quality is kept unimpaired over great distances.

By J. S. LYALL,
B.Sc., A.M.I.E.E., A.C.G.I.

THE average radio enthusiast is very often in comparative ignorance of the part played by land circuits in the distribution of radio programmes.

Although it may sound paradoxical, it is not possible to utilise radio communication to its maximum advantage without employing land lines, and a brief consideration of the various problems presented by a national broadcasting network, particularly in regard to music transmission, will enable this to be appreciated.

The rapid growth of broadcasting in a thickly populated continent like Europe has necessarily resulted in a large number of transmitters. The wavelength bands allocated for broadcasting are comparatively narrow, and, in consequence, it is impossible to give satisfactory service by means of relatively few very high power transmitters on account of mutual interference. This situation has given rise to the "regional" scheme, the general features of which are well known.

An essential part of any country's regional system is a comprehensive arrangement of permanent connecting links between the various studios and transmitters in the network, quite apart from an occasional need for connections for broadcasts of items of particular national or international interest. Without this interconnecting means every separate

station would have to provide its own programme material, and the cost of such a proceeding would be prohibitive if the present varied programmes were to be maintained simultaneously at all stations.

The Wireless Link

Two methods are available for establishing these connections:—

(i) The programme can be sent out from a central transmitter, picked up and re-radiated from other stations.

(ii) The studio responsible for the programme can be connected by land lines to any desired number of transmitters.

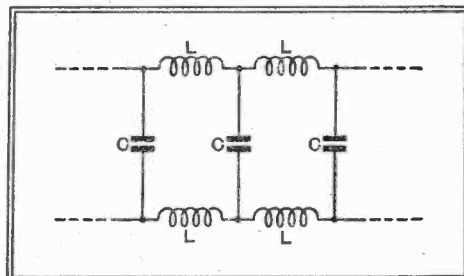

Fig. 1.—An elementary filter circuit illustrating the effect of "loading" a cable. L denotes the loading coils and C the capacity between conductors.

The first method is at present impracticable, mainly on account of fading and atmospheric disturbances. Readers will remember early attempts to re-radiate American and Continental programmes in this way, and, while it must be recognised that the results were highly creditable in view of the attendant difficulties, these transmissions served to indicate that the solution of the problem was not to be found in this way. The second method, on account of its much greater reliability and flexibility, has, therefore, been adopted all over the world in countries possessing a commercial telephone system, and tens of thousands of miles of special circuits are at the present time in constant daily use.

In order fully to appreciate the problem of making telephone circuits capable of transmitting music efficiently, it is necessary to consider briefly the history of the development of the modern circuit used for speech transmission.

The popular conception of a long-distance telephone circuit rarely involves more than a pair of wires slung from an unsightly pole or contained in an underground cable. It is true that the earliest circuits consisted of thick copper conductors carried on insulators, but these have now been almost entirely replaced by underground cable circuits on account of their greater reliability in bad weather.

Simultaneous Broadcasting—

As a result of bringing the two conductors close together in a cable, the capacity between them has been increased, and, owing to the loss caused by the shunt capacity, it was still necessary to employ comparatively thick wires in order to limit the loss and ensure satisfactory transmission.

The next step was to add series inductance at intervals along the circuits to compensate for the shunt capacity, this being called "loading." It was then found to be more economical to provide thinner conductors and to amplify the weakened speech currents at intervals.

It will readily be appreciated that the inductance added to the circuit, in conjunction with the distributed capacity, gives the circuit a characteristic somewhat similar to that of an ordinary simple type of low-pass filter, as shown in Fig. 1, and that, at a certain point in the frequency range, the attenuation increases rapidly. Since a frequency range of from 200 to 3,000 cycles per second suffices for satisfactory commercial speech transmission, circuits intended for this purpose are designed in such a way that the cut-off occurs at a frequency near the upper end of this range. On account of this limitation a modern telephone circuit will not transmit music without considerable distortion, and special circuits and amplifiers must, therefore, be provided having a much wider frequency range.

The component parts of the latest radio transmitter and studio equipment cater for practically straight line response over a range of 50 to 8,000 cycles per second; this range is wider than that catered for in the majority of existing radio receiving

sets and should, therefore, meet the requirements for a considerable number of years. The same range has been adopted for permanent connecting land lines, since the capital cost involved in laying a tele-

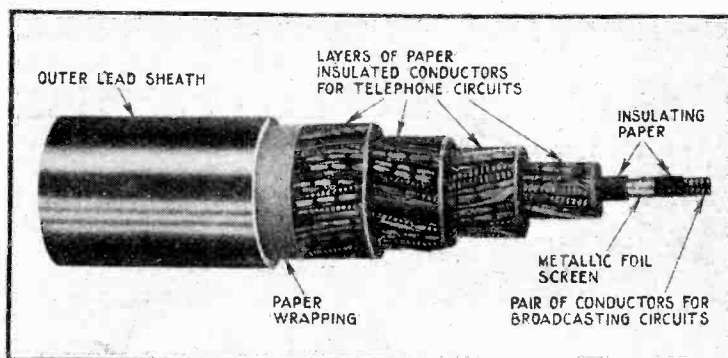

Fig. 2.—Photograph showing the usual arrangement of the broadcasting circuit in the cable.

phone cable is very large, and the facilities provided must remain adequate for a long period.

The Cable Circuit

The actual type of circuit used consists of a pair of paper-insulated conductors, each about 1 mm. in diameter, twisted together and provided with a screen consisting of a wrapping of copper or lead foil, which makes the circuit immune from interference from other circuits in the same cable. This screened circuit is usually located in the centre of the cable, and it is surrounded by a great many pairs used for ordinary telephone conversations. Fig. 2 shows a typical cable incorporating broadcasting facilities. "Loading" coils are added at intervals of just over a mile, these generally having an inductance of the order of 15 millihenrys or less.

Such circuits have come into general use only comparatively recently; early S.B. work was carried on over the old overhead circuits which had been discarded for telephone traffic in favour of new cable circuits. These circuits are in one way very suitable for music trans-

mission, since, due to the absence of the cut-off effect, they transmit a wide band of frequencies without much distortion. They are, however, very unreliable in bad weather, and very liable to interference from power transmission lines. In some countries, where cable facilities are not yet fully developed, this type of circuit still continues to give adequate service.

The Amplifiers

As has been mentioned previously, it is necessary to add amplifiers, usually called "repeaters," at intervals along the cable route. These are generally located in special buildings distant from each other by about 50 miles. Here again it is necessary to improve on the performance of the amplifiers used for ordinary speech in order to meet very stringent requirements, particularly as regards response characteristic, variation of amplification with input voltage, and ratio of harmonics to the fundamental. The latest amplifiers employed for S.B. work, of which one type is illustrated in Fig. 3, are usually capable of giving a flat amplification characteristic from 30 to 10,000 cycles per second within ± 0.5 decibel. The amplification must, of course, be variable to cater

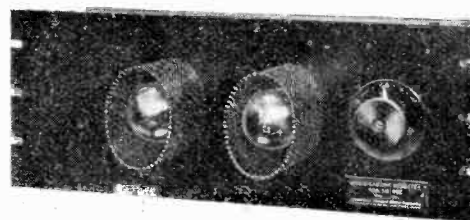

Fig. 3.—A typical amplifier used in "S.B." work.

for circuits having differing attenuations. Care is also taken to avoid interference with amplifiers carrying ordinary telephone conversations, screening being employed where necessary. Fig. 4 shows the circuit of a type of amplifier commonly used.

Associated with the amplifiers are equalisers which enable the overall characteristics of one section of line com-

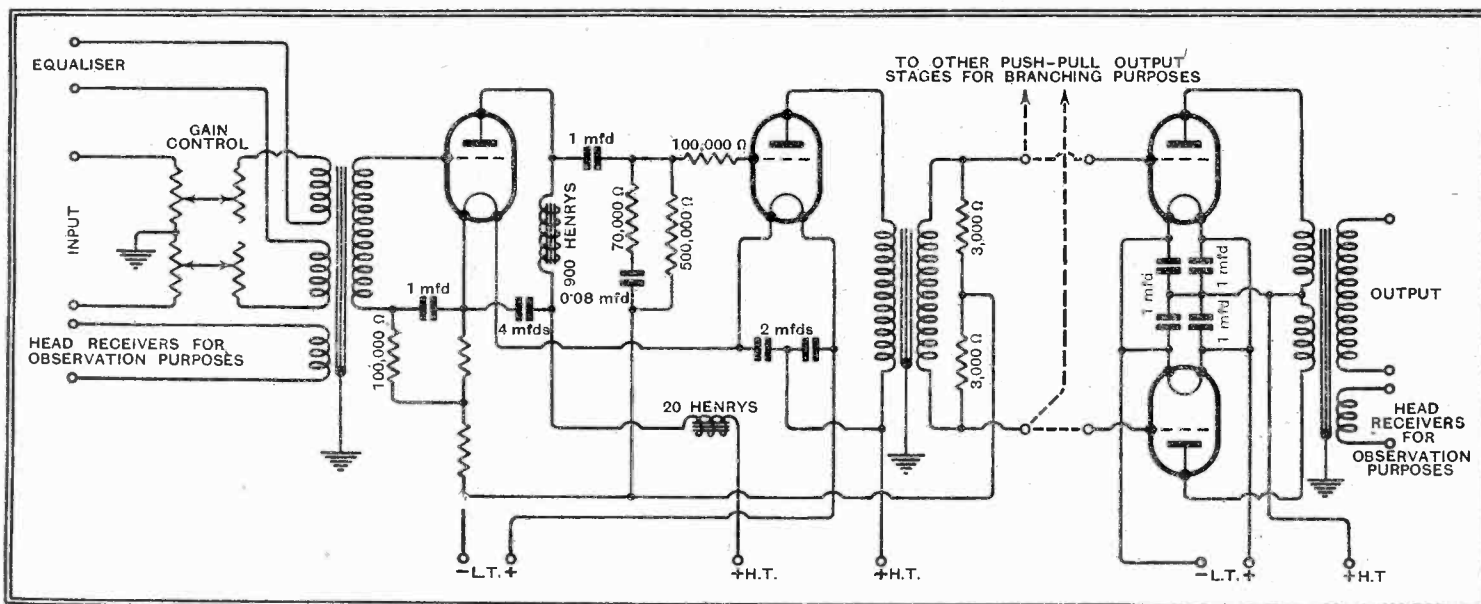

Fig. 4.—Circuit diagram of a typical amplifier.

Simultaneous Broadcasting—

combined with an amplifier to be made flat over the desired frequency range. The characteristic of an actual section measuring 42 miles is shown in Fig. 5.

The Overall Connection and its Control

The complete circuit between any two points, consisting of a number of equalised sections, should normally be perfectly satisfactory for transmission, but in the case of very long circuits it is sometimes necessary to compensate at a convenient point for slight irregularities or cumulative errors. Apart from this type of correction, known as attenuation equalisation, it is desirable in the case of extremely long

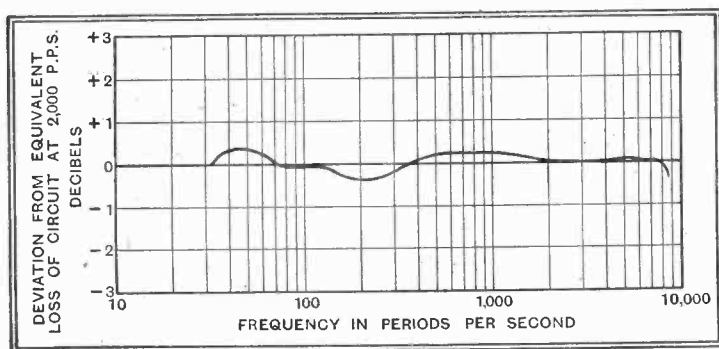

Fig. 5.—A typical response characteristic for a section of cable after amplification and equalisation.

circuits to install further correctors in order to compensate for phase distortion or the difference in the time taken for currents of different frequencies to travel along the circuit.

An important advantage of having the circuit split up into a number of completely equalised sections is that they may be switched together to form complete circuits as required without the necessity for any adjustments.

The actual method of utilising the lines for distributing programmes varies in different countries. In this country the principal studios and transmitters are permanently connected together by numbers of lines, and the direct control of the circuits is, therefore, in the hands of the British Broadcasting Corporation. In other countries each studio and transmitter is connected to the telephone network at the nearest station equipped with amplifiers, and all switching and branching at this and similar stations along the route is carried out under the supervision of the telephone administration staff. In the latter case it is necessary that facilities be provided at intermediate points for transmitting the same programme simultaneously in several directions. The amplifier itself is the most convenient point at which to effect this branching operation, and the method frequently employed is seen in Fig. 4. In some countries it is not unusual to have the same programme sent in this way to four or five branches.

The longest complete circuits in regular use in Great Britain measure about 600 miles, and contain nine or ten intermediate amplifiers. Transmission over

these circuits is now so perfect that the average listener to, say, London Regional, is unable to detect whether the programme comes from a studio in London or in Edinburgh, 400 miles away. It is unfortunate that such excellent results cannot also be obtained in all outside broadcasts, some of which are of definitely national interest, but in these cases it is often a matter of making the most of the lines available, which, for traffic reasons, may not even be handed over to the B.B.C. engineers until a short time before the actual broadcast.

For international broadcasts much larger distances are involved; for example, in the case of a concert relayed from Warsaw there were in use some 1,500 miles of special circuit containing over thirty intermediate amplifiers between Warsaw and London. In addition, branches were provided along the circuit for connection to the networks in Germany, Switzerland, Belgium, and other countries, involving many more hundreds of miles of cable and a great many more amplifiers.

In order that the circuits shall give continuous reliable service frequent tests are necessary.

Testing the Circuits

Each amplifying station is furnished with means for the measurement of amplification, and also the voltage level on the circuits themselves. Fig. 6 shows an accurately calibrated valve voltmeter which is very often employed for these measurements, while Fig. 7 shows a heterodyne oscillator suitable for use with it. The frequency of this oscillator is continuously variable from 20 to 11,000 p.p.s. by the rotation of a single knob.

At certain important points on the route peak voltage indicators are sometimes



Fig. 6.—Measuring apparatus for routine maintenance tests on amplifiers and circuits.

bridged across the circuit during transmission, their function being to detect any tendency to overload the amplifiers.

As regards the cable circuit, precision instruments are employed for periodic measurements of insulation and conductor resistance. These are so sensitive that incipient faults are in very many cases discovered and rectified before there is a risk of complete failure of the circuit.

Another important safeguard is obtained by making periodic tests to ensure that valves are discarded before they actually fail in service; in addition, a

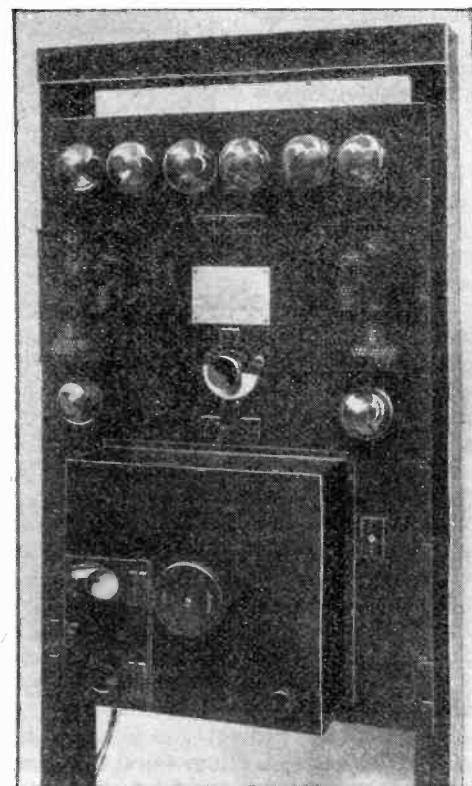

Fig. 7.—A heterodyne oscillator for testing purposes.

comprehensive system of alarms immediately calls attention to faults such as failure of L.T. or H.T. voltage in any particular amplifier.

The author is indebted to Standard Telephones and Cables, Ltd., for permission to reproduce the illustrations of apparatus.

BOOKS RECEIVED

The Autocar Handbook (12th Edition) by B. P. W. Twist, M.A., of *The Autocar*. Completely re-written in the light of the progress made in Automobile design during the past few years. Pp. 228 with 301 illustrations. Published by Iliffe and Sons Ltd., London. Price 2s. 6d.

Ray-Controlled Mechanism, by Major Raymond Phillips, describing various methods of controlling mechanism, especially model aircraft, trains and boats, by wireless, sound, and light. Pp. 96, with 42 illustrations and diagrams. Published by Percival Marshall and Co., Ltd., London. Price 2s. 6d.

Elements of Engineering Acoustics, by L. E. C. Hughes, A.G.C.I., D.I.C., B.Sc., Ph.D. An account of the factors which influence the reproduction and distortion of sound, including the measurement of sound intensities, electro-acoustic measurements, microphones, amplifiers and reproducers. Pp. 159 + xi., with 32 diagrams and 4 plates. Published by Ernest Benn, Ltd., London. Price 8s. 6d.

PRACTICAL HINTS AND TIPS

Simplified Aids to Better Reception

IT is generally appreciated that a Class "B" output valve consists of two entirely separate valves enclosed in a single glass envelope. But when it comes to testing for defects this point is sometimes forgotten, and it is not appreciated that,

Testing Class "B" Valves

even if one section of the valve fails entirely, the other will still give results of a sort, although distortion will be serious, and volume will be reduced. The simplest way of making a test is to insert a milliammeter in turn between each end of the output transformer primary winding and each anode. The absence of any current in one position will indicate a complete failure in the associated valve (or should it be half-valve?). A considerable difference between the two current readings will also suggest that something is wrong.

UNDER the influence of continuous vibration, the valves in a portable receiver sometimes show a tendency to work loose, and even to come right out of their holders. It is generally possible to prevent this by wedging the valve in position with the help of a block of sponge rubber, as shown in the accompanying illustration.

Secured Against Vibration

Part of a cheap rubber sponge will serve the purpose admirably. A somewhat similar plan may be em-

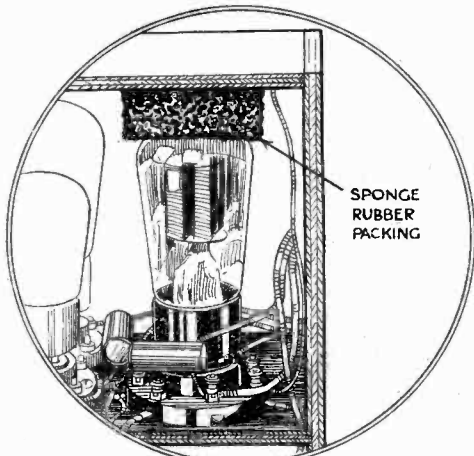

Sponge-rubber packing for a loosely fitting valve in a portable set.

ployed when it is found desirable to mount the valve "anti-microphonically" in order to prevent acoustic reaction. In a portable, an attempt to mount the valve really freely will often lead to disaster

when the set is treated roughly. But an excellent shock-absorbing mounting can be made by placing one strip of sponge rubber under the valve holder, and another above the bulb in the manner shown.

GREAT improvements have taken place during the last year or so in the design and construction of small rotary H.T. generators, operating from a low-tension accumulator battery of anything up to 12 volts. A specialised and important application of these machines is the supply of anode current for car radio sets, but they have many other uses. For an L.T. consumption varying between less than 1/2 amp. and about 2 1/2 amps., an H.T. output considerably greater than can be economically derived from dry batteries is obtainable.

Another Source of H.T.

Apart from the topical question of "car radio," attention may be drawn to the fact that these small generators, driven from a car battery, provide in many cases for country dwellers an excellent solution of the problem of H.T. supply for the domestic set where there is no mains supply.

The ignition and lighting system of cars is usually maintained in a deplorable condition, but wirelessly-minded people can be expected to attend to their electrical equipment rather more sympathetically than does the average motorist. With a little extra care and perhaps occasional use of the starting handle for freeing the engine and "sucking-in," particularly during cold weather, there seems to be no doubt that the battery of the average car does not object to a little additional work. In many cases, indeed, it is all the better for it.

In Fig. 1 is shown an H.T.-from-the-car installation which has proved eminently practicable, and which, so far, has given no trouble whatsoever. In the garage one of the H.T. generators described above is installed permanently on the wall, and arrangements are made to connect it, via an on-off switch and flexible leads, through the dashboard sockets to the 12-volt car battery. A pair of lead-covered leads are used to pass the H.T. output from the generator to the receiver which is installed in the adjoining house; as a refinement, a simple remote-control relay is fitted for operation of the on-off switch.

When the car is out of the garage, the motive power for the H.T. generator is, of course, lacking, and so an emergency H.T.

battery, thrown into use by a switch, is provided as an emergency source of anode current.

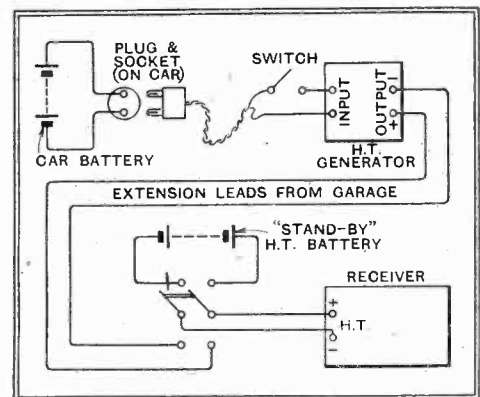

Fig. 1.—High tension supply from a car battery. Simplified installation diagram of a practical installation.

An alternative to this system would be to install the generator, not in the garage, but in the house; this would avoid the need for a remotely-controlled on-off switch, but would necessitate heavy connecting leads to avoid loss of voltage.

WHEN resistance-capacity coupling is employed in place of the more usual L.F. transformer, it is better to err on the side of over-biasing rather than under-biasing the amplifying and output valves. Even in the best regulated and most ambitious amplifiers, occasional overloads are likely to occur, and it is as well to take a little trouble to minimise their ill-effects.

R.C.C. Operating Conditions

An over-biased amplifying valve will act as an anode-bend detector when it is overloaded, and if under-biased grid current will flow momentarily. Of these two evils, anode-bend rectification is by far the least harmful. When grid current is flowing the coupling condenser will acquire a charge, and the audible distortion resulting from a momentary overload will be prolonged until the charge leaks away.

It is not difficult to ascertain definitely what is happening provided that a milliammeter be inserted in series with the anode of the valve. If the meter needle kicks upwards we have an indication that bias is on the high side, as it should be. A downward deflection shows that grid current is flowing.

Conquering the Atlantic

A Pioneer Tells How Long-distance Wireless Began

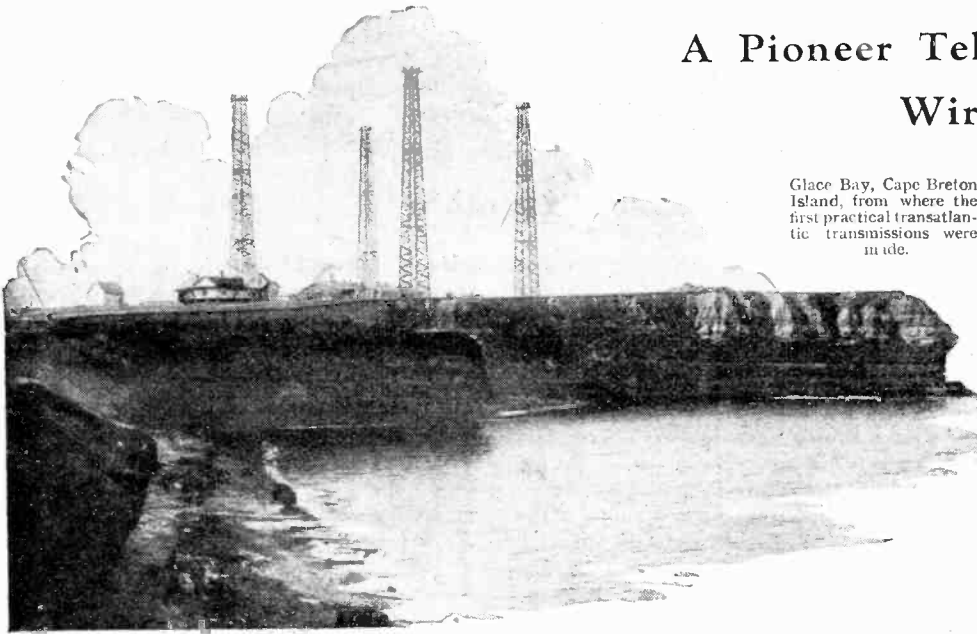

Glace Bay, Cape Breton Island, from where the first practical transatlantic transmissions were made.

EXCEPT on those occasions—happily growing more rare—when reception is marred by Morse interference, the broadcast listener of to-day is blissfully unconscious that other wireless activities are afoot. He hardly realises that a large proportion of the world's telegraphic traffic, and all transoceanic telephony, is borne by wireless.

Anyone who would like to learn more of these things, and who is in any way interested in the development of wireless, should read a recently published book¹ by Mr. R. N. Vyvyan, who retired a short time ago from the position of Engineer-in-Chief to the Marconi Company.

Adventure in the Ether

Mr. Vyvyan, in his working life, has seen every stage of practical development, and more, has borne a distinguished part in it. Unlike many engineers, he can write for the layman without appearing to be condescending, and at the same time without omitting matter that is of real interest to the technician. He tells a first-hand story of adventure in the ether, which, in its way, is just as thrilling as a tale of derring-do in other spheres of activity.

The author joined the Wireless Telegraph and Signal Company (later to become the Marconi Company) early in 1900, and was one of a band of seventeen technical assistants that Marconi had gathered round him for the purpose of putting his inventions on a commercial basis. "All were very enthusiastic, and realised that they were assisting in the development of a new industry."

Up to this time an induction coil and

¹ *Wireless Over Thirty Years.* By R. N. Vyvyan. Pp. 256. with 16 illustrations and 12 diagrams. George Routledge and Sons, Ltd., London, 1933. Price 8s. 6d. net.

accumulator were used for transmitting, while the coherer was the only practical receiver; the long-distance record stood at a mere 150 miles. Short as was this range, it was at least enough to show that the curvature of the earth did not present an insuperable barrier to wireless signals, and Marconi boldly decided to short-circuit intermediate stages of progress by attempting at once the transmission of signals between the Old World and the New across the Atlantic Ocean. Thousands of miles, instead of mere hundreds, were to be covered, and it was decided that some 25 kilowatts, discharging across a 2-in. spark gap, would be necessary.

Although little was then known about the propagation of electromagnetic waves, it was at least realised that they travelled better over sea than over land, and so in these early experiments the aim was to give them a good send-off by building the stations on the water's edge. A site was chosen at Poldhu, near Mullion, in Cornwall, and young Vyvyan, who had graduated from power-station engineering to wireless, was selected as the right man to build the station. This job finished, he crossed in 1901 to America to erect a corresponding station at Cape Cod.

At both stations the aerial system was supported by a ring of twenty wooden masts about 200 feet high, and the first set-back came when both mast systems promptly collapsed in the first breeze of wind. Impatient of delay, Marconi decided temporarily to abandon Cape Cod, to "jury rig" the Poldhu aerial, and proceed to St. Johns, Newfoundland, in the hope of being able to carry out reception tests of signals from England. It was here that the famous "S" signals were received with the help of a kite-supported aerial. One assumes that the letter "S" (••••) was used in place of the more distinctive and conventional test signal "V" (•••—) because the over-stressed transmitter was likely to break down under the strain of a prolonged dash!

No sooner had these encouraging results been achieved than further experiments were stopped summarily by the action of a cable company which claimed monopoly of all telegraphic communication in Newfoundland. At this juncture the Canadian Government played the fairy god-mother by offering to bear the cost of building a station in Canada. As recom-

pense, Marconi undertook that the existing telegraphic rates between that country and England would be reduced if success were achieved.

Vyvyan, who had in the meanwhile completed the Cape Cod station, and managed to snatch a short holiday in England, was commissioned to erect the Canadian station at Glace Bay, from which the first really practical tests were conducted.

Glace Bay was completed in October, 1902, but early attempts to receive signals from Poldhu were unsuccessful,

nothing but weak and unintelligible signals being heard. It was accordingly decided to reverse the tests, and, larger power being available at Glace Bay, to let that station transmit to a receiver at Poldhu.

Then came a series of heartbreaking

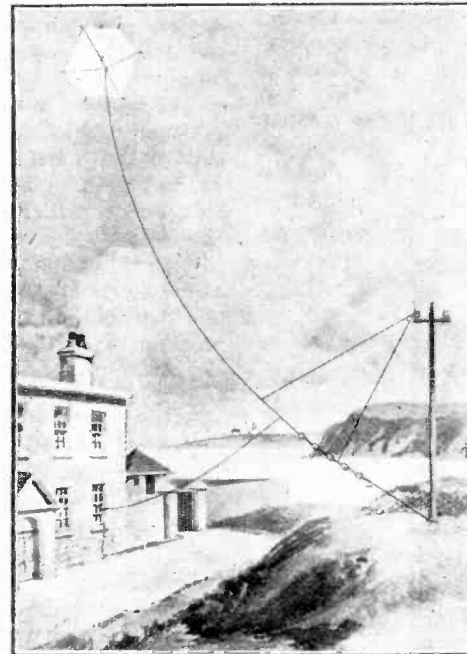

Constant aerial capacity not guaranteed: the receiving station at Signal Hill, Newfoundland.

Conquering the Atlantic—

reverses, with nothing but occasional and intermittent reception to encourage the pioneers. Imagine their difficulties; they had no wavemeters, little, if any, knowledge of wavelength and its effect on range; and, worst of all, no knowledge of varying conditions in the ether. As the author says, "an arrangement which gave good results one night gave indifferent results the next night, and it thus became difficult to state for certain whether any improvement or progress was being made."

It was, however, realised that signals travelled better by night than by day. Consequently, laborious days were devoted to adjusting apparatus and setting up new circuits and aerials, while weary nights were spent in slowly pumping out the messages that were seldom received at the other end. Many of the alterations were in the direction of increasing power and widening the spark gap to the limit of endurance of the condensers and other transmitting apparatus. A spark gap of 100 millimetres in length is mentioned by the author; the discharge across it must have been a truly awe-inspiring sight and sound.

After weeks of hard work, Poldhu first reported good signals on November 28th, 1902, and on December 15th a news bulletin for *The Times* was successfully transmitted; it was held up at the receiving station, however, in order that it might be preceded by messages to the Kings of England and Italy. Over-stressed by the transmission of *The Times* message, the gear broke down, and it was not till five days later that the loyal telegrams were safely despatched and received.

An Unfortunate Atmospheric

Communication was still very uncertain, and sometimes a message was repeated twenty-four times without success. The low croaking note of the spark transmitter was almost indistinguishable from atmospheric, often with unfortunate results. Vyvyan, who was still in charge of the station, sent a personal telegram reading:—

"Times London by transatlantic wireless Please insert in birth column Jan. 3rd wife of R. N. Vyvyan Chief Engineer Marconi's Canadian Station of a daughter."

It was received at the other end as "Jane third wife of . . ."; an atmospheric had supplied the superfluous "e."

Slowly progress was made, and, a measure of success having been achieved, Cape Cod joined Poldhu and Glace Bay in a triangular attack on the Atlantic, messages being relayed via Glace Bay from

the United States to England. Further evidence of the variability of the little-known medium through which these pioneer signals passed was afforded by the fact that messages from Cape Cod were occasionally well received by Poldhu direct, although they were inaudible at Glace Bay, the nearer station.

Encouraging as were these experiments, it was realised that a commercial tele-

not until directional aerials, a musical spark discharger, and transmitting circuits designed to produce more persistent oscillations were evolved that a limited public telegraph service was opened in October, 1907. Crowning some six years of endeavour, an unlimited service began in 1908.

In the development of long-distance wireless communication, Great Britain was leading the whole world, and episodes illustrating international jealousy are described by the author. The culminating point of his own career probably came, after distance had finally been conquered in 1926, when "I myself saw signals sent from one of the Imperial beam stations recorded, not only once, but three times, at intervals between each record of one-seventh of a second, proving that the signals had made a complete circuit of the world three times, and had recorded themselves on each circular tour."

A Wireless History

Although the birth of transatlantic wireless has been described at length, it actually forms a small part of Mr. Vyvyan's book. Chapters are devoted to such subjects as the work of the earlier pioneers, to long-range stations other than those mentioned, and, of course, to the development of the beam system. Wireless in war, on land, sea, and in the air is treated, and space is devoted to various aspects of broadcasting and to research problems of the future.

Very wisely, purely technical matter is contained in an appendix, illustrated by circuit diagrams of early apparatus. The book makes a valuable contribution to wireless history, and, as much of it antedates even the earliest files of *The Wireless World*, will have an honoured place in our library.

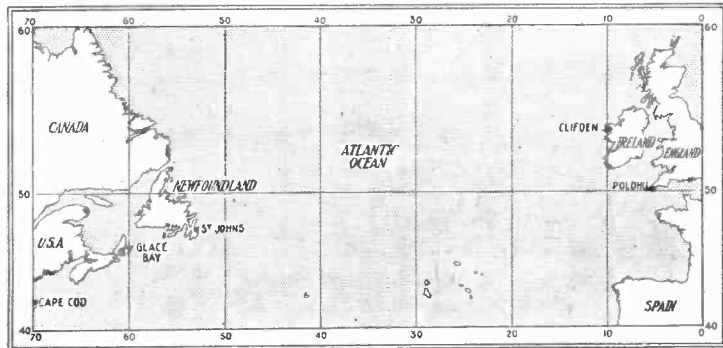

The North Atlantic Ocean was the cradle of long-distance wireless. This sketch map shows the positions of the early stations.

graph service was still a long way ahead. Greater power and bigger aerials seemed to be necessary, and so new stations were built, the old ones being made to earn their keep by transmitting news bulletins to the Cunard liners at £10 per hundred words received.

At this juncture Poldhu dropped out of the transatlantic trio, as the site did not permit of the erection of a large enough aerial. Its place was taken by a new station at Clifden, on the west coast of Ireland.

Although the new stations hardly gave results up to expectations, signals from Glace Bay were received in daylight, which was a notable advance. But it was

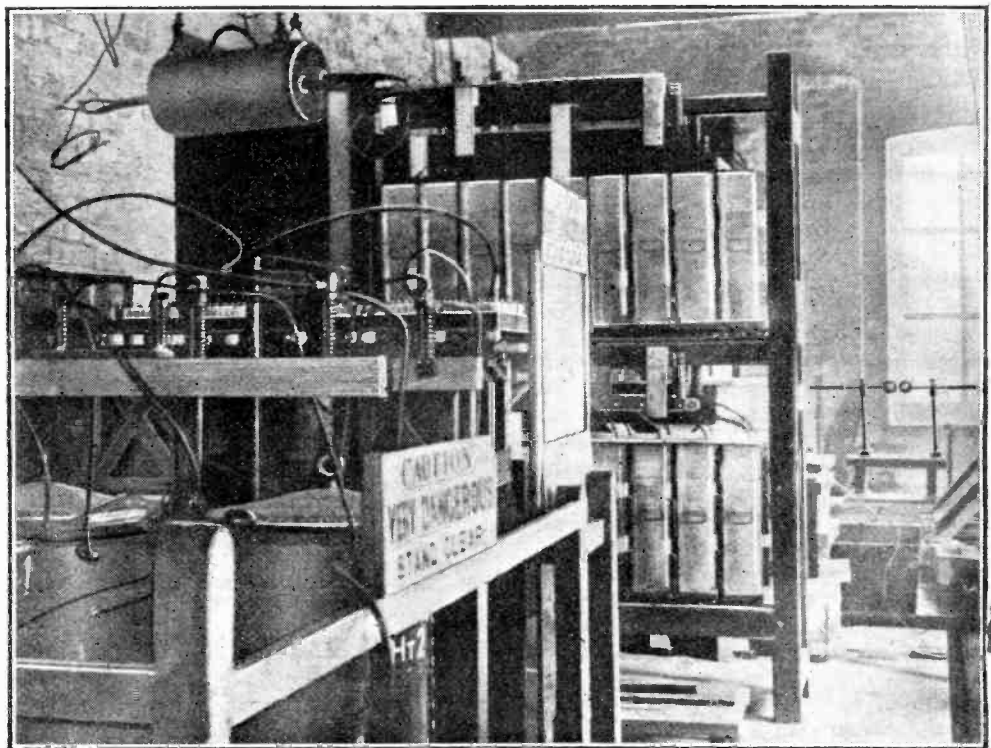

Original transmitting gear at Poldhu, showing the spark gap and condensers.

Why the Double-Hump?

Band-Pass Tuning Investigated

By G. W. O. HOWE, D.Sc., M.I.E.E.

IF a condenser be charged as shown in Fig. 1, and then connected in series with an inductive coil by closing the switch, the initial discharge current will be forced by the inductance of the coil to carry on until the condenser is charged in the reverse direction; the current then reverses, and the process goes on with decreasing amplitude until the energy has all been dissipated. The discharge is thus a damped oscillatory current of a certain frequency which we call the natural frequency of the circuit. This frequency is decreased by an increase of either the capacity of the condenser or the inductance of the coil; it is inversely proportional to \sqrt{LC} . The phenomenon is analogous to that which occurs if a pendulum bob is displaced and then released; in that case there is only one factor by which we can alter the frequency, viz., the length of the pendulum, because the other factor—the force of gravity—is beyond our control.

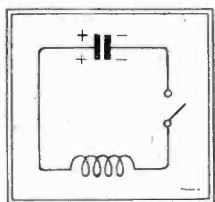

Fig. 1.—A simple oscillatory circuit.

the support of the other; they are thus coupled together to an extent which can be varied by tightening or slackening the supporting cord. If one pendulum is set oscillating, it gradually builds up an oscillation in the other one, and goes on doing this, not—as one might expect—until the first one comes to rest. The second one now returns the compliment, and builds up an oscillation of the first one, and so they go on, first the one and then the other, until all the store of energy has been expended. In Fig. 3 the upper curve represents the oscillations of the first pendulum, and the lower one those of the second.

Two coupled pendulums can be made to oscillate without "beats"

An oscillation which varies in amplitude in this way can be analysed mathematically into two steady oscillations of slightly different frequencies. When two notes a semitone apart are played on an organ one hears the "beats" produced in the resultant sound. There is no need, however, to analyse these somewhat com-

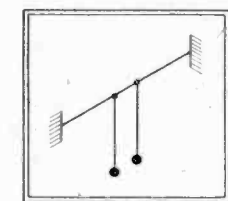

Fig. 2.—Pendulums coupled through a common support.

tend to increase the motion which the pendulum already has. In a similar manner the oscillatory electric circuit can be tuned until it gives maximum response to an alternating electromotive force acting upon it. This is done by varying either C or L, or both, until the natural frequency of the circuit is about the same as the frequency of the e.m.f. which is acting upon it.

If two pendulums of the same length are hung from a horizontally stretched cord, one cannot swing without moving

***B**AND-PASS filters have now become commonplace in wireless receivers yet the reasons for the double tuning hump of the filter and particularly the causes of uneven humps are often not clearly understood. These points are carefully explained in this article.*

will swing together as one, and there will be no exchange of energy between them. The same is true if they are initially displaced in opposite directions and simultaneously released, as shown in Fig. 4 (b). In Fig. 4 (a) they are always moving in the same direction, whereas in Fig.

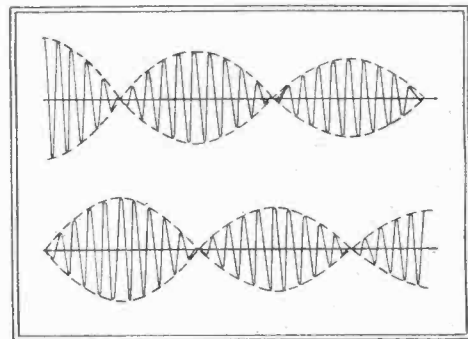
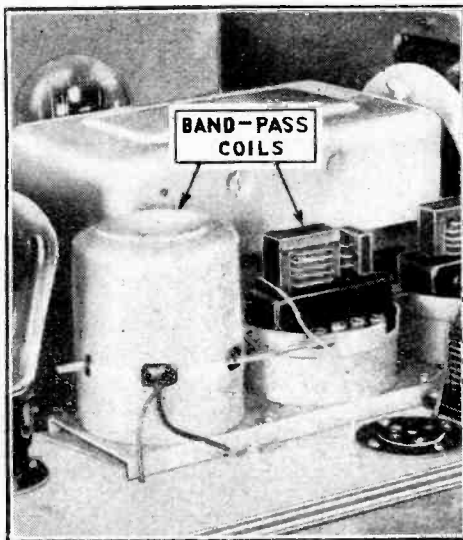

Fig. 3.—Showing the interchange of energy between two coupled pendulums.

4 (b) they are always moving in opposite directions. If the oscillations per minute be counted, it will be found that in Fig. 4 (a) they are slower than those of one of the pendulums above, whereas in Fig. 4 (b) they are faster. The reason for this is fairly obvious, for in Fig. 4 (a) each pendulum moves the point of suspension of the other in such a direction that the effective length of the pendulum is increased, whereas the reverse is the case in Fig. 4 (b). This will be clear from Fig. 5. We see, then, that such an arrangement has two possible natural frequencies, and consequently, if it be subjected to a periodic impulse, the frequency of which can be varied, it will be found that there are two frequencies to which it gives a large response.

Let us now consider two similar oscillatory circuits tuned to have the same



The band-pass equipment of a modern receiver using Ferrocart iron-dust cored coils. The screening cover has been removed from one of the coils.

plex resultant oscillations of the two coupled pendulums, because we can easily arrange matters so that either the one or the other of the two components is produced. If both pendulums are held as in Fig. 4 (a) and then released, they

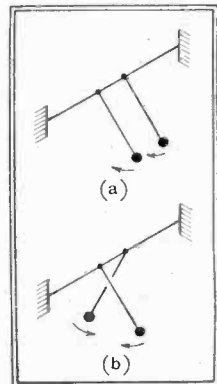

Fig. 4.—Coupled pendulums made to give a single frequency without "beats." (a) lower frequency, (b) higher frequency.

Why the Double-Hump?

natural frequency and coupled together—that is, so placed or connected that an oscillatory current in one tends to set up an oscillatory current in the other. Let us assume that the circuits can be opened by means of switches, the condensers charged, and the switches then closed at the same moment. If the condensers are charged, as shown in Fig. 6 (a), the oscillating currents will flow through the coils in the same direction at every moment, and the magnetic field of each will be increased, due to the proximity of the other, and, since they are assumed to be similar and carrying the same current, the effective self-inductance L of each coil is increased to $L+M$, where M is the mutual inductance of the two coils. Since the natural frequency is proportional to $1/\sqrt{L}$, the effect of the proximity of the other coil will be to decrease the frequency in the ratio $\sqrt{L/(L+M)}$. If, on the other hand, the initial charges of the condensers are as shown in Fig. 6 (b), on closing the switches the initial current rushes will be in opposite directions as shown, and at every moment the currents will be equal and opposite, thus decreasing the magnetic field of each just as if their self-inductances had been decreased from L to $L-M$. This will cause the natural fre-

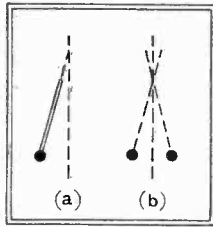

Fig. 5.—Showing that the effective length of the pendulum in 4 (a) is greater than in 4 (b).

quency to be increased in the ratio $\sqrt{L/(L-M)}$. Two coupled circuits tuned to the same frequency have therefore two natural frequencies, and consequently if they are acted upon by an electromotive force, the frequency of which can be varied, it will be found that there are two frequencies at which exceptionally large currents are set up. If we call the higher frequency f_h and the lower one f_l , it will be seen that $f_h/f_l = \sqrt{L+M}/\sqrt{L-M} = \sqrt{1+k}/\sqrt{1-k}$ where $k=M/L$; k is called the coupling coefficient. If the coils are not similar, $k = \frac{M}{\sqrt{L_1 L_2}}$.

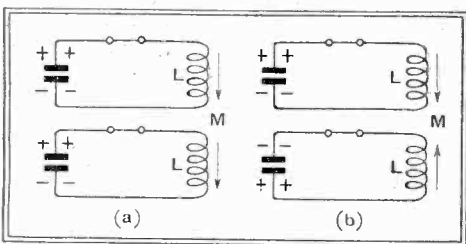

Fig. 6.—An electrical analogue of Fig. 4.

There are many other ways in which two circuits may be coupled, but the two natural frequencies can always be found

by assuming the condensers to be charged in a certain way and simultaneously discharged. In Fig. 7 the two circuits are coupled by means of the inductive coil L_c which is common to both circuits. In Fig. 7 (a) the discharge currents of both condensers pass together through L_c , and if one imagines L_c to be replaced by two coils each of inductance $2L_c$ connected in parallel, one of them may be allotted to each circuit, making its total inductance $L+2L_c$. In Fig. 7 (b) the oscillatory current flows around the circuit as shown, and L_c plays no part whatever; it is like the galvanometer in a balanced Wheatstone bridge, since it connects two points between which there is no P.D. The effective inductance of each circuit is thus

only L . The ratio f_h/f_l is thus $\sqrt{\frac{L+2L_c}{L}}$.

If the coupling is due to a common condenser C_c , as shown in Fig. 8, then in a similar manner it may be replaced in imagination by two condensers each of capacity $C_c/2$ in parallel, so that each circuit in Fig. 8 (a) will have an equivalent capacity equal to that of C and $C_c/2$ in series, that is, $C C_c / (2C + C_c)$, whereas the coupling condenser plays no part in the oscillation in Fig. 8 (b), and the effective capacity in each circuit is C . Hence the ratio of the two frequencies $f_h/f_l = \sqrt{\frac{2C+C_c}{C}}$.

A point to which we wish to draw special attention is that with the common inductance coupling it is the lower frequency oscillation that passes through the coupling element, whereas with the common condenser coupling it is the higher frequency oscillation that does so.

We see, then, the reason for the two

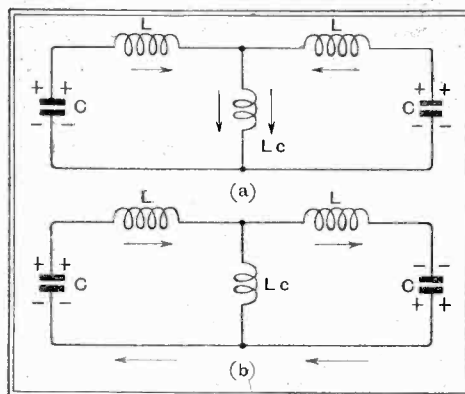

Fig. 7.—Here L_c replaces the horizontal cord in Fig. 4.

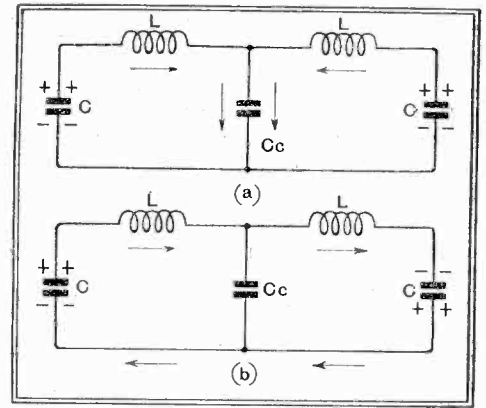
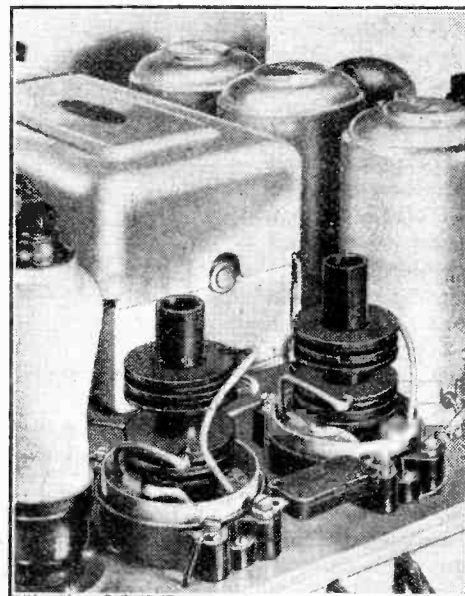

Fig. 8.—Here C_c acts as the connecting link between the two circuits.

humps that appear in the resonance curve of two coupled tuned circuits. They correspond to frequencies at which the currents in the two circuits are either exactly in phase or 180° out of phase. Now it is often observed that the two humps are not equal in height, that is to say, that



The two coil units of a superheterodyne band-pass I.F. stage. The coils are screened by metal covers when in use.

although the electromotive force acting on the circuit is the same, a much larger current is sometimes set up at the one resonant frequency than at the other, and the larger hump is sometimes at the higher and sometimes at the lower frequency. Now the reason for this will be made clear by a consideration of what we have just seen to be the paths of the currents in these two special cases. At a resonant frequency the effect of the inductance is neutralised by the effect of the capacity, and the current is deter-

mined by the magnitude of the electromotive force acting on the circuit and the total effective resistance of the circuit.

In Fig. 7 (a), for example, any resistance in the coupling link L_c will limit the current corresponding to this, the lower resonant frequency, whereas such resistance will be without effect in Fig. 7 (b), since for this higher resonant frequency no current passes through the coupling link. We see, then, that with this type of coupling any effective resistance in the coupling link will reduce the height of the lower frequency hump, but not of the higher.

With the type of condenser coupling shown in Fig. 8 it is at the higher resonant frequency that the current passes through the coupling link, and we shall therefore find that with this type of coupling it is the higher frequency hump that is reduced.

In some cases one of the humps may

Why the Double-Hump?

be so reduced as to be almost obliterated, giving the impression of a single-humped but distorted resonance curve.

With the arrangement of two distinct circuits shown in Fig. 6 there is no direct increase or decrease of resistance loss, whether the currents flow in conjunction or in opposition, but in the latter case the resultant magnetic field is less, and any losses due to the field might be reduced, thus causing the higher resonant frequency hump to be the more pronounced, although the stray fields might easily produce the reverse effect.

It must not be imagined, however, that inductive coupling always causes the shorter wave hump to predominate, and capacity coupling always the longer wave hump.

In Fig. 9 (a), where the initial charges of the condensers are such that there is no voltage across the coupling condenser, the initial discharge currents will be as shown, and there will at no time be any voltage across the coupling condenser, which consequently plays no part in the oscillation. The frequency is determined by L and C . In Fig. 9 (b), on the other hand, the initial charges are assumed to be such that the voltage across the coupling condenser is twice that across either of the main condensers. The point P will always be at a potential midway between that of the plates of the coupling condenser, and the introduction of a metal sheet as shown dotted would not affect the oscillation. The circuits on either side of this metal sheet can be considered separately, and, remembering that the capacity of either half of the coupling condenser is $2C_c$, it can be seen that the effective capacity is that of C and $2C_c$ in parallel, which is $C+2C_c$. Hence, in this case, it is the longer wavelength oscillation that utilises the coupling element and that will be reduced by any resistance in the coupling element. It can be seen that $f_h/f_l = \sqrt{\frac{C+2C_c}{C}}$.

If, in any of the cases considered, it is desired to reduce the sharpness of tuning by inserting resistance, it should be inserted in the main circuit, where it will affect both humps, and not in the coupling link, where it will reduce one and not the other, and thus cause distortion of the resonance curve.

The Output Circuit should be Screened from the Aerial

Resistance in the coupling element is not the only thing which will cause the two humps to differ in height. If, owing to defective screening, the aerial current induces E.M.F., not only in the input, but also in the output circuit of the filter, it is easily seen that the effect will be to increase the height of one hump and decrease that of the other. In Fig. 9, for example, it is seen that at the frequency corresponding to one hump, the currents in the two coils are flowing downwards at the same moment (Fig. 9a), whilst at the frequency corresponding to the other

hump the current in one is flowing down when that in the other is flowing up (Fig. 9b). If, now, the aerial is coupled in some way to both the filter circuits, it must be in such a way as to tend to set up currents either as in Fig. 9 (a) or as in Fig. 9 (b), one or the other, depending entirely on the nature of the fortuitous coupling between the aerial and the output circuit of the filter. In one case the

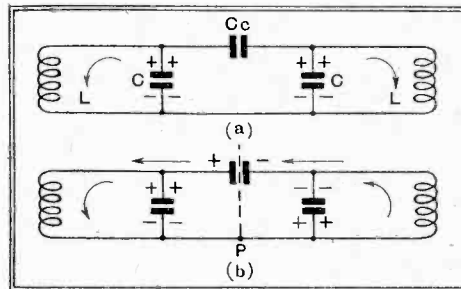

Fig. 9.—Another type of capacitive coupling.

two electromotive forces induced in the filter from the aerial will act in conjunction on the long-wave hump and in opposition on the short-wave hump, whereas in the other case the reverse will be true, but unless done intentionally to counteract other causes of inequality it will be pure chance which of the two humps will be increased and which decreased.

Mr. C. W. Oatley gives an experi-

mental curve showing dissymmetry due to this cause in Fig. 11 of his article in the November 1932 number of *The Wireless Engineer*.

Reaction—improperly applied—may cause distortion

When reaction is employed the output of the valve following the filter is coupled in some way with the filter circuit. Now the anode output will bear a fixed relation in magnitude and phase to the input to the grid, which is determined by the current in the output circuit of the filter. From what we have just seen with regard to Fig. 9, it is obvious that there is no such fixed relation between the anode output and the current in the input circuit of the filter. The phase relation between these are reversed on passing from one hump to the other, and any attempt to obtain reaction by coupling back to the input side of the filter or to the aerial would probably cause very pronounced distortion of the resonance curve. The results of our investigation may be summarised as follows: To obtain a symmetrically double-humped resonance curve from a two-circuit tuner, the coupling link should be as free from loss as possible, the aerial should be coupled only with the input circuit of the filter, and any reaction should be obtained by coupling with the output circuit only.

DISTANT RECEPTION NOTES**French Broadcasting Mysteries Explained**

As already stated in *The Wireless World*, the Luxembourg delegates left the Lucerne Conference some days before it drew to a close, packing up their traps and departing for home. Nor did they even trouble to appoint proxies to vote for them. This is a serious position, for a 200-kilowatt station, determined to grab a long wave, may wreck the long-wave position of the Plan unless strong steps are taken, and taken right early.

There is, I hear, no possibility that the St. Agnan station of Toulouse will eventually be taken over by the PTT under the Ferrié regional scheme for France. A brand new 120-kilowatt Government station is now under construction some twenty miles from Toulouse. St. Agnan will probably be limited to its present 8 kilowatts, and if it is allowed to broadcast at all after January 15th it may have to work on one of the French common-wave channels.

Recently I mentioned that Radio-Vitus had a complete high-power station in being, and only waits for permission to broadcast. I now hear that there is another huge silent station near Nice. It is difficult to see what could have been responsible for this epidemic of building unauthorised stations in France, but with Toulouse, Radio-Vitus, Nice and Lyons there are now at least four of them ready or almost ready for action. The only solution would seem to be to turn most of them into short-wave transmitters.

Toulouse, by the way, remained silent for a long time after the preliminary broadcast which I reported a week or two ago in these notes. The station is now at work again on 385 metres—at least, it was on the evening prior to the writing of this para-

graph, and I trust that a regular service is now in being once more. With a power output of only 8 kilowatts the St. Agnan station is very well received, and readers should not fail to tune it in.

Possibly you have heard the new 50-kilowatt Dutch station at Kootwijk, which is conducting tests on the long wave outside programme hours.

More Power at Week-ends ?

I wonder whether readers have noticed how many Continental stations are nowadays most strongly received on Saturdays and Sundays. Either new transmitters are given a testing run at the week-ends or the normal power is considerably increased at these times. Frankfurt Moravska-Ostrava, Genoa, Bratislava, Vienna and Oslo are examples. In any event, one can usually make a much bigger bag of stations on Saturday or Sunday evening than at any other time during the week.

On the long waves Kalundborg is now quite unreceivable owing to interference from Monte Ceneri and Russian stations. The pick of the long-wave stations are Radio-Paris, Huizen, Zeesen, Warsaw and Motala.

Reception on the medium waveband is amazingly good at present, at least twenty-five stations being receivable with good quality and volume on most evenings. With so many to choose from it is difficult to make a selection of the best, but I would strongly recommend Rome, Lyons Doua, Strasbourg, Breslau, Heilsberg, Turin, Trieste, Florence, and Munich.

D. EXER.

UNBIASED By FREE GRID

How to Screen Your Aerial

WE have all heard of the very great advantages conferred by a screened aerial down-lead in cases where electrical interference of a certain type is rampant, and many of us can personally vouch for the fact that its virtues have not been exaggerated. I do not think, however, that even its makers could claim such marvellous properties for it as does the wireless scribe of a newspaper circulating in one of the landladies' paradises on the South Coast.

During some of his "experiments" with a down-lead of this type he has made the remarkable discovery that for "purely local interference" one of the best methods of using it is to dispense with the horizontal and simply use the screened down-lead as an aerial, the actual screening-cover being employed as an earth connection.

The only comment I have to make is that he must have a pretty poor opinion of the screening properties of the stuff if he thinks that signals can get through to the internal wire, and the manufacturers of the down-lead won't thank him for publishing the results of his experiments. Perhaps, however, he thinks that enough signal strength can get in through the hole at the top. If, as seems obvious, all the signal collecting is being done by the external screen, where does the screening come in?

Special Note

AN astonishing instance of the colossal ignorance of many listeners concerning the broad principles of radio communication and even of ordinary telephone work came my way the other day.



Should not put their mouths so close.

I happened to be taking tea with a lady of mature years, a nonagenarian in fact, who has built up quite a reputation for herself in the village near which I dwell owing to the fact that as a small girl she once saw Heinrich Hertz studying the waves at Margate.

Being somewhat hard of hearing, she finds that headphones are her mainstay.



All he had to do.

Disused Duckponds, Use of,

AS most people have discovered, the position which is most suitable for the easy manipulation of a receiver is seldom one that permits of anything but a long and straggling earth lead. But a correspondent, who recently put down the necessary half-crown as a deposit for a delightful suburban villa of the sort now springing up on the outskirts of our big cities, found an ingenious method of solving the earthing problem.

He discovered that underneath the floorboards of all ground floor rooms there was nothing but a quagmire instead of the concrete or brick such as you get in the five-bob houses. All that he had to do, therefore, was to drive an earth tube into the mud and pass the connecting wire through a small hole in the floorboard in the corner of the room in which the set was placed, and heigh presto! he had the shortest and most direct earth possible.

All went as merrily as the proverbial marriage bell for a few months until the disused duckpond, typical of the sort upon which these houses are usually built, dried up. Signals then fell off rapidly owing to the dryness of the earth, for, as those of you who read the article in *Wireless World* for June 2nd will know, experiments have shown that the resistance of dry soil is well over a thousand times that containing the normal amount of moisture.

My correspondent has written to me stating that he wishes to patent his earth-under-the-floorboards idea, but first wishes to perfect it, and he requests me to ask my readers to assist him in his project. At present he has bored a small hole in the floorboard to take the spout of a funnel down which he pours a bucket of water every morning, but he desires to have ideas concerning some less crude method of irrigation.

Personally speaking, I am of the opinion that most of the B.B.C. programmes have been so wet lately that all that should be necessary would be a receptacle to catch the drips from the loud speaker.

After complaining that no inventor had bothered to produce a really comfortable type of headphones, she added that people who broadcast should have better manners than to put their mouths so close to the microphone.

For the moment I could not imagine what she was driving at, and thought that she was merely referring to blasting; what was really in her mind flashed upon me only when she carefully unscrewed the caps of the earpieces and commenced wiping the accumulated moisture from the diaphragms.

Aid for the Deafened

I AM delighted to see that certain cinema magnates have taken the advice which I offered them some months ago (on March 24th, to be exact) and have caused certain of their seats to be fitted with headphones and volume controls. At a recent performance which I attended at a well-known London cinema results were all that could be desired. As regular

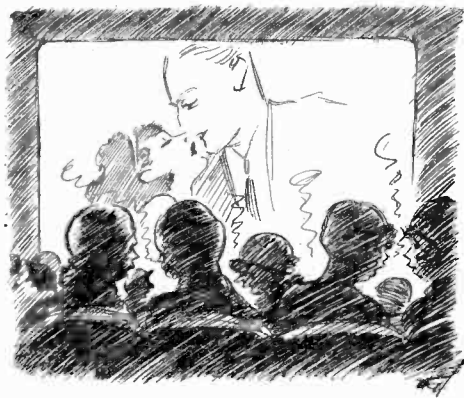

Heard clearly above the babble.

readers may remember, my purpose in seeking to have them fitted was to enable the speech from the screen to be heard clearly above the babble caused by the chattering of the garrulous females who are the mainstay of these gilded haunts of pleasure.

The managers of the cinemas which have taken my advice obviously did not wish to offend their best customers, however, and they have, therefore, shown infinite tact and diplomacy in announcing that these headphones are intended for the deaf; in fact, they have even gone so far as to have the installation carried out by a well-known firm of deaf-aid manufacturers.

Not only have the cinema magnates taken the idea up, however, but it has extended even to ecclesiastical circles; in the newly built church of St. Alban the Martyr at Golders Green, one of London's more luxurious suburbs, plug-in points and a volume control have been fitted in each pew. Single earpieces on a lorgnette handle are provided instead of the usual headphones.

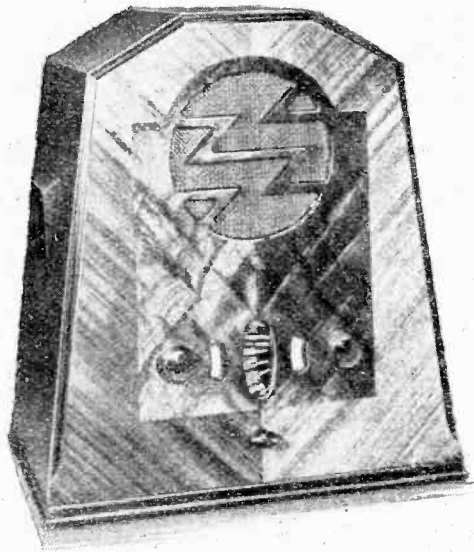

Ferranti "GLORIA" CONSOLE

A Superheterodyne Notable for its Advance Design and High Selectivity

A SUPERFICIAL comparison between the specification of the latest model Ferranti superheterodyne and the equivalent model of last year is sufficient to show that no pains have been spared to ensure that the new season's model shall be thoroughly up-to-date and include as many as possible of the technical advances which have proved their worth during the past year.

Probably the most important new feature is the introduction of automatic volume control in conjunction with a duo-diode-triode valve of Ferranti manufacture in the second detector stage. The control is delayed; that is to say, it does not come into operation until the signals picked up on the aerial reach a predetermined value. The advantage of this arrangement over simple A.V.C. is that the sensitivity of the set is in no way impaired when receiving weak signals. According to the maker's figures, the range over which the control is operative is from 100 microvolts to 250,000 microvolts in the aerial circuit, and it is stated that a good output is obtained from a signal of only 10 microvolts.

Another important feature is the introduction of an image rejector circuit between the aerial and grid circuit of the first H.F. valve. The function of this circuit is to reduce whistles due to second channel interference.

The valves in the first three stages are of the latest variable-mu pentode design and, like the second detector, are of Ferranti manufacture. The output valve is a triode capable of delivering an undistorted power output of 2½ watts.

Externally, the set is very similar in appearance to last year's model, but there are one or two important additions to the controls which contribute to the efficiency and ease of handling of the set. A small meter movement has been introduced as a tuning indicator which not only gives an approximate idea of the strength of the incoming signal but also enables the set to be tuned accurately to the station being received. This is a matter of some importance when automatic volume control is used, as on powerful stations it has the effect of apparently flattening the peak of the resonance curve. In last year's model the tuning scale was calibrated alternatively in wavelengths or in stations, but in the present model both calibrations are given, the scale being divided into two sections, viewed through separate windows. Finally, a continuously variable tone control now takes the place of the switch-operated high or low tone control of last year.

FEATURES

Type.—Six-stage mains-operated superheterodyne with delayed A.V.C. and tuning indicator. Internal moving-coil loud speaker. Provision for gramophone pick-up and external loud speaker (low impedance). **Circuit.**—Signal-frequency H.F. with image rejector—separate oscillator—first detector—I.F. amplifier—duo-diode-triode second detector—triode output valve. Full-wave valve rectifier. **Controls.**—(1) Main tuning with separate illuminated scales for wavelength and station calibration. (2) Manual volume control. (3) Wave-range and on-off switch. (4) Tone control. **Price.**—24 guineas. **Makers.**—Ferranti, Ltd., Hollinwood, Lancs.

The set gives good results from the pick-up on the mains leads and a special aerial plug and socket is fitted so that when the external aerial is disconnected from the set the mains aerial is automatically brought into operation.

The signal-frequency H.F. stage is coupled to the first detector by a tuned transformer designed to give uniform amplification over the wave-range. It will be noticed that the pick-up coils for the separate oscillator valve are included in the secondary circuit of this transformer. The intermediate frequency stage includes two

Complete circuit diagram of the Ferranti superheterodyne. The tuning indicator meter is connected in the anode circuit of the H.F. stage.

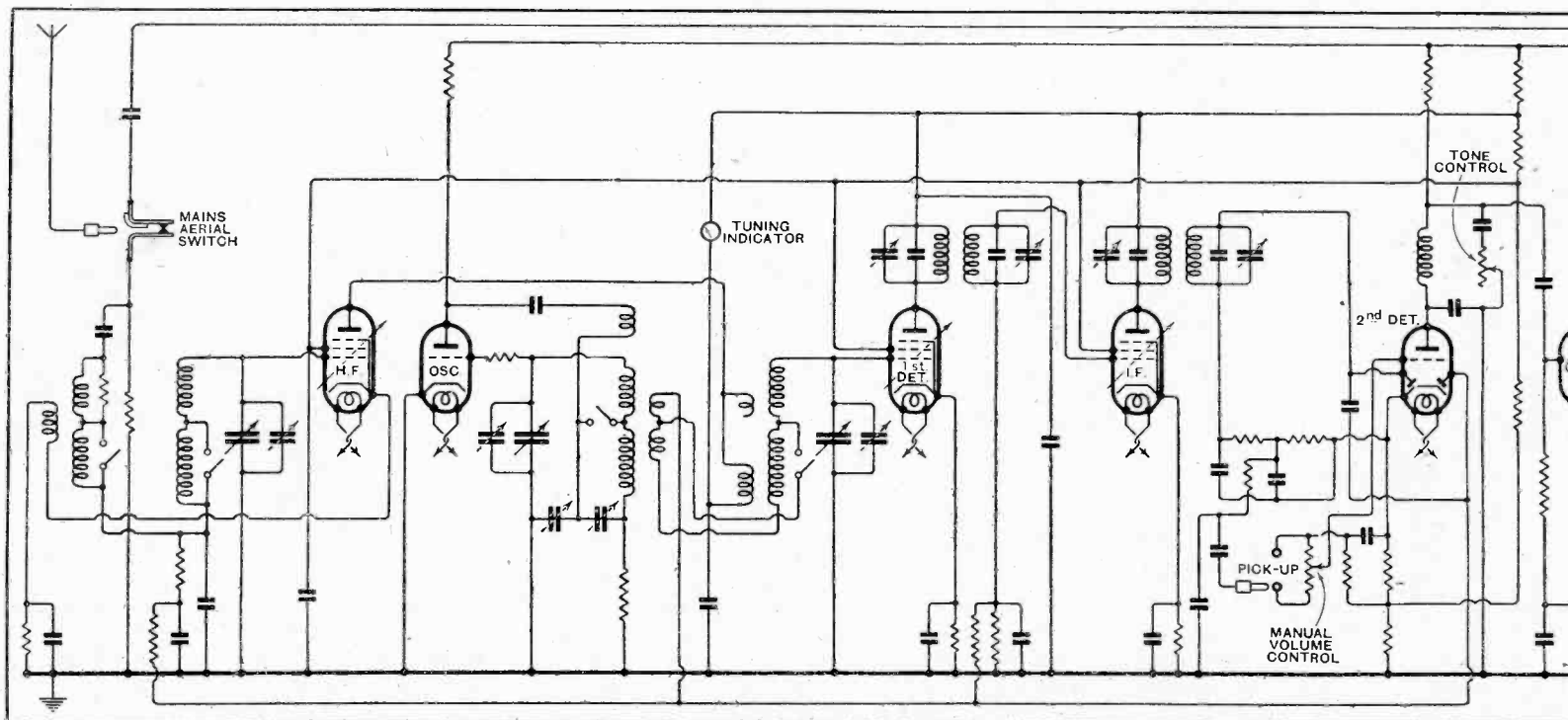

Letters to the Editor

The Editor does not hold himself responsible for the opinions of his correspondents

Correspondence should be addressed to the Editor, "The Wireless World," Dorset House, Stamford Street, S.E.1, and must be accompanied by the writer's name and address

Components

MAY I add a few further words in reply to Mr. G. M. Mew's letter of July 7th, regarding component prices.

He is, of course, splitting hairs when he corrects my statement of cellulose "paint" for cellulose "enamel." It is quite immaterial what the "coating" is, but the fact remains that the spraying is an unnecessary extra cost to the article concerned.

Regarding Mr. Mew's other statement concerning transformer shrouding, etc., I can only ask him how he accounts for most of the manufacturers using "stripped and undecorated" parts for their receivers! Surely they would not do so if there was the slightest chance of the set going wrong and creating a bad name; besides, compare the size of a bought set to a home-constructed one of the same type! I have one particular set in mind which has the crudest and most unfinished appearance inside, but it "delivers the goods," and I have yet to hear another set which gives an equal performance at the same price. I still contend that component prices can easily be reduced.

E. J. B. CURTIS.

Bournemouth.

Television

PROPOS Mr. Wood's letter in your issue of July 21st.

It may interest Mr. Wood to know that television has been regularly broadcast by the B.B.C. since September, 1929, that it is regularly received in the North of England (by the intelligent people) and on the Continent, that public demonstrations have been given in most parts of the country (including a period of several months in Yorkshire) and at many of the Olympia Radio and other exhibitions.

Having had a wide experience in wireless circles, it is strange that I have never yet heard of the Halifax Wireless Club, or, what is more strange, never seen or spoken to anyone who has seen or spoken to anyone who knows anyone who has heard of it!

T. H. BRIDGEWATER.

Sutton, Surrey.

WE are surprised to learn that a gentleman of Mr. Lewis Wood's experience and intelligence has not yet made an opportunity to investigate the possibilities of television, and can assure him that the trouble taken in fitting up the apparatus is amply repaid in the results obtained.

This company has been experimenting with the reception of television images by means of the Cathode Ray Tube for some months past, and is giving regular demonstrations of the reception of the Baird programme from the B.B.C. at the works at Ponders End. We extend a cordial invitation to Mr. Wood to visit the works if he is in the locality at any time, when we will

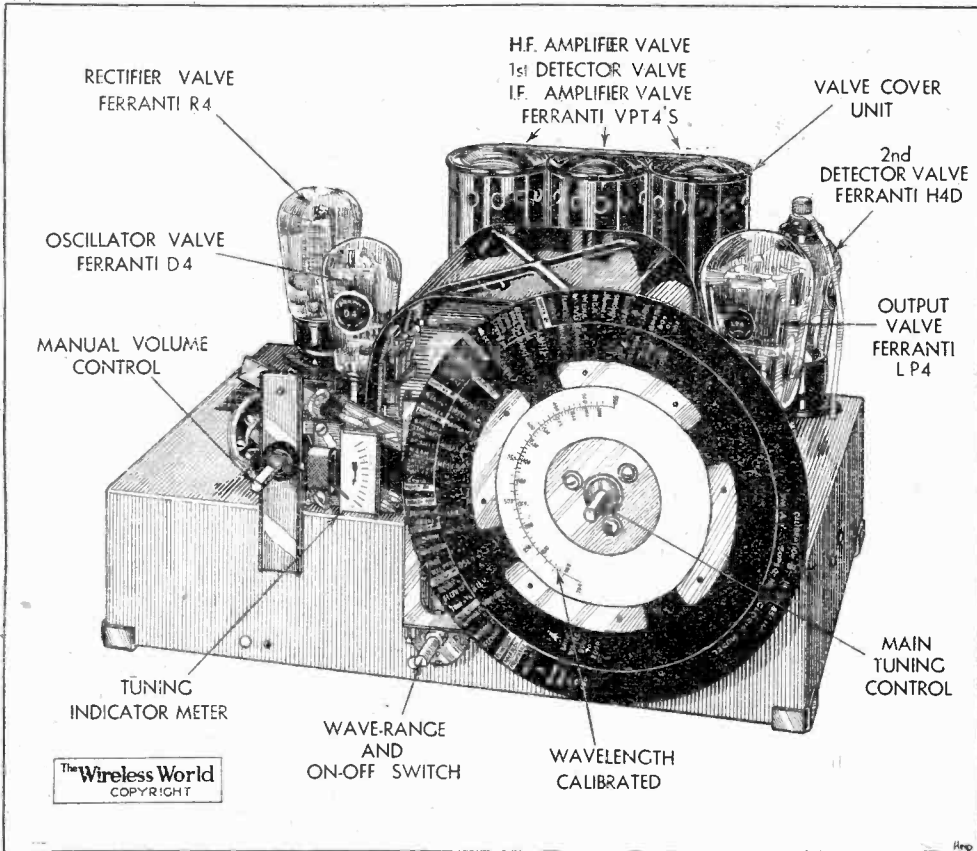

In addition to the controls shown in this view of the Ferranti "Gloria" chassis, there is a tone control which is mounted on the loud speaker unit.

transformers in which both primary and secondary are tuned, and it is in this stage and in the signal-frequency H.F. stage that automatic volume control is effected. A somewhat complicated system of resistances and condensers associated with the second detector is arranged to give the requisite threshold bias for the delayed A.V.C. and includes the manual volume control and the connections for introducing the output from the gramophone pick-up into the triode section of the valve. The pick-up must be removed before reverting to radio reproduction and a plug inserted in one of the pick-up sockets as indicated at the back of the chassis. The variable tone control, consisting of a condenser and resistance in series, is connected across the output from the second detector, which is resistance capacity coupled to the power valve. The moving coil loud speaker is of Ferranti manufacture and includes a hum-bucking coil. An external loud speaker of low resistance may be connected in parallel with the secondary of the output transformer. The power supply is derived from the full-wave rectifier and is

smoothed by the loud-speaker field winding from which the bias to the output valve is derived.

The set has exceptionally good range and power output, and at no time is there any feeling that the set is being throttled, as is sometimes the case with simple A.V.C. It is probably because of the general liveliness and sensitivity of the set that interference noises entering *via* the mains appeared to be rather high, but the normal 100 cycle mains hum was literally negligible.

Selectivity on medium waves is particularly good, and although in Central London the adjacent channels on either side of the two local transmitters may suffer from side-band interference, the next channels on either side, *i.e.*, 18 kc/s from the local, are absolutely free from local interference of all types. On long waves Zeesen was received clear of Daventry, but with a slight background of side-band "splashing" from Radio Paris.

The quality is notable for the breadth of the response in the bass which, although it tends to make speech somewhat low-pitched, is a distinct asset in the reproduction of orchestral music. In view of the fact that the top cut-off appears to be in the region of 3,500-4,000 cycles, we found it preferable to keep the tone control in the maximum "high" position. This, however, is essentially a matter of personal taste. Although on technical grounds it is not a procedure which can be recommended, it is worth while noting that the general pitch of the response could be raised by operating the receiver slightly off-tune.

A good deal of thought has obviously been given to the mechanical design of the chassis, which is a thoroughly sound engineering job. The set, as a whole, is completely shock-proof, and the screening covers for the valves cannot be lifted until a safety lock plate in the base has been unscrewed.

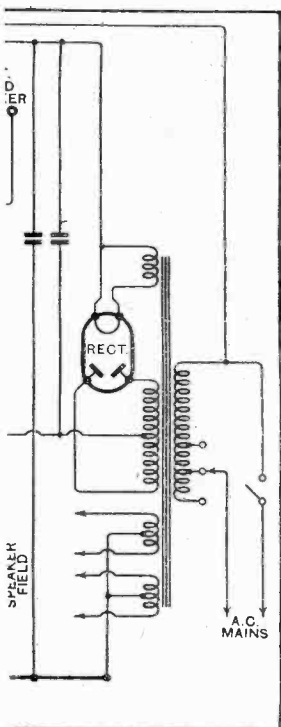

endeavour to convince him that this branch of radio engineering offers great scope for the enterprising amateur.

We would be the first to admit that the reception of television by the Cathode Ray Tube has not yet attained perfection, but we are confident that the simplicity of control, noiselessness and economy in operation give this method of reception distinct advantages from the amateur's point of view.

We are taking the liberty of forwarding full particulars of the circuit to your correspondent, and hope that we shall hear of his conversion to the ranks of television experimenters in the future.

THE EDISON SWAN ELECTRIC
CO., LTD., RADIO DIVISION.

G. PARR,

Technical Service Department.

London, W.C.2.

AS an ordinary man in the street with some small experience of wireless and kindred matters I would like to inform your correspondent Mr. Lewis J. Wood that the science of television is actively studied by a far larger number of amateurs than seems to be appreciated in Yorkshire, the natural abode of the intelligent.

The popularity of television is, to the writer's personal knowledge, increasing very rapidly at the present time, and is likely to go on increasing, during the next few years, at a rate which will stagger the sceptical.

This is due very largely to the advent of the Cathode Ray oscillograph, which is now produced at a price that enables its interesting possibilities as a television reproducer to be explored by almost every amateur who so desires.

Personally, I am most grateful to the B.B.C. for their special transmissions of television, and perhaps Mr. Wood himself may also be indebted to them before long instead of adopting an attitude of (assumed?) ignorance and scorn as he now does.

R. McV. W.

London, W.C.1.

A Challenge to "Free Grid"

THE criticism made in your pages under the heading "Acoustics in Courts" cannot pass unchallenged, especially the remark that "one must infer that prior to this installation magistrates have been following the cases by lip-reading or some similar method."

When our sight begins to fail and we take to spectacles, few would be unkind enough to suggest that we must have been incapable of attending to business previously. To take advantage of equipment to combat a slight infirmity due, in this case at least, to many years devoted to the public's interests shows to my mind an appreciation of radio technique of which the readers of *The Wireless World* may well be proud.

Pp. RADIO-AID, LTD.,

CHARLES M. R. BALBI.

London, S.W.1.

Well Repaid

WHEN the filament consumption of valves first became o.i. you printed a letter from me asking the manufacturers to think more about reducing the H.T. consumption rather than to get anxious about my accumulator. I certainly felt that a lot could be done in that direction but never expected quite the reduction that can be accomplished by the intelligent application of Q.P.P. principles.

My expenditure on this year's *Wireless World* will certainly be well repaid.

I have been searching my files to see exactly how long ago I wrote that letter. I have not found it, chiefly because, I believe, I kept finding items of interest in the old numbers and my attention wandered.

And so, rather belatedly, but not from my

fault, I should like to thank our valve manufacturers for the interest they are putting into Q.P.P. and B. May I repeat to them your remarks about the cost of components, especially that of screen-grid valves.

WILLIAM B. WEST.

In Next Week's Issue:—

"The Wireless World"

MODERN BATTERY FOUR

A Battery Set with "Mains" Performance

THE development of Class "B" amplification has rendered possible the production of this battery operated receiver with a performance closely approaching that obtainable from a mains set, and which is yet economical in its demands upon the batteries. In order to obtain adequate sensitivity and selectivity for modern conditions, a variable-mu type H.F. valve is used in conjunction with three tuned circuits employing iron-core type coils. Reaction on to the intervalve circuit is provided from the grid detector and this valve is transformer coupled to the driver stage. The Class "B" valve is fed through a step-down transformer and its output is taken to a high quality moving-coil loud speaker.

In spite of the essential simplicity of the arrangement, both electrically and mechanically, a very high standard of quality is assured while maintaining the total quiescent anode current below 10 mA. The sensitivity is sufficient to permit full loud speaker reception of a number of Continental programmes in daylight with a good aerial, and after dark dozens are available, while the selectivity largely removes the blanketing effect of the locals. No difficulty is experienced in receiving distant stations situated in wavelengths between the two locals, while the volume control in conjunction with the local-distance switch gives a full range of control on all stations.

- | | |
|---|----------------------------------|
| 1 Reaction condenser, 0.0005 mfd.
(Ormond No. 8 Semi-Circular type
(Magnum)) | |
| 1 Resistance, 100 ohms 1 watt | Claude Lyons |
| 1 Resistance, 5,000 ohms 1 watt | Claude Lyons |
| 5 Resistances, 10,000 ohms 1 watt | Claude Lyons |
| 1 Resistance, 250,000 ohms 1 watt | Claude Lyons |
| 3 5-pin Valve Holders
(Dubilier, Erie, Seradex.) | Clix Chassis mounting type |
| 1 7-pin Valve Holder
(Goltone, Peh, W.B.) | Clix Chassis mounting type |
| 2 H.F. Chokes
(Goltone, Kinva, Wearite.) | McMichael Binocular Junior |
| 1 L.F. Transformer, 3½:1
(Igranic, R.I., Varley.) | Ferranti AF8 |
| 1 Driver Transformer
(Benjamin, Bulgin, Ferranti, Igranic, Multitone,
R.I., Telsen, W.B.) | Varley D.P.41 |
| 1 5-way Connector | Wilburn |
| 1 3-pin Plug complete with socket panel | Belling-Lee No. 1119 |
| 4 Ebonite shrouded Terminals, aerial, earth, pick-up (?) | Belling-Lee Type "B" |
| | (Burton, Clix, Ealex, Igranic.) |
| 1 Wire-wound Volume Control, 5,000 ohms | Claude Lyons Type P.58 |
| | (Colvern, Haynes Radio, Watmel.) |
| 1 5-way Cable, 30in. with plugs and spade ends | Belling-Lee |
| | (Goltone, Harbros, Lewcos.) |
| 1 C.B. Battery, 4½ volts | Siemens C.1 |
| | (Grosvenor.) |
| 3 C.B. Plugs | Clix Type "B" |
| | (Belling-Lee, Ealex.) |
| 1 C.B. Battery Clip | Bulgin No. 2 |
| | (Gripso.) |

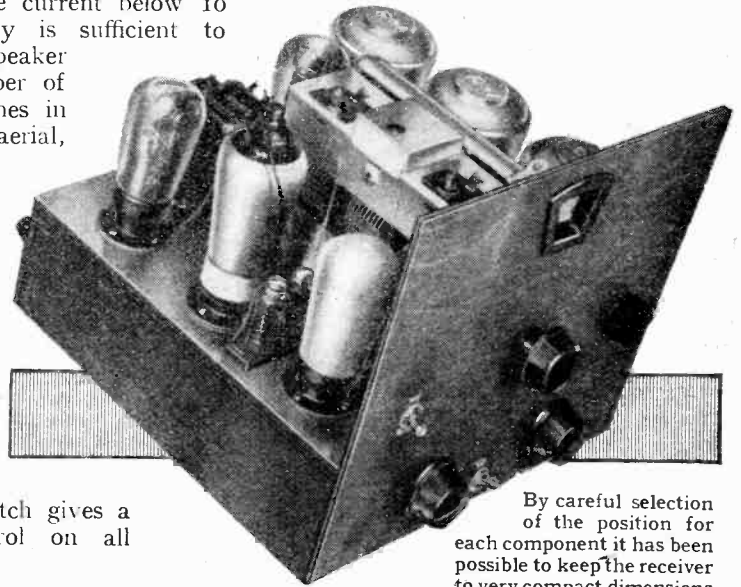

By careful selection of the position for each component it has been possible to keep the receiver to very compact dimensions.

LIST OF PARTS

After the particular make of component used in the original model, suitable alternative products are given in some instances.

- | | |
|---|--|
| 1 Three-gang condenser, 0.0005 mfd. and dial
Utility W.314/3
(British Radiophone, Polar.) | |
| 1 Assembly of three coils
Varley "Nicore" BP30 | |
| 3 Fixed condensers, 2 mfd. 750 v. D.C. test
Peak Type A3 | |
| 2 Fixed condensers, 0.1 mfd. tubular
Peak Type "M" | |
| 2 Fixed condensers, 0.005 mfd. tubular
Peak Type "M" | |
| 1 Fixed condenser, 0.01 mfd.
Graham-Farish | |
| 1 Fixed condenser, 0.0001 mfd.
Graham-Farish | |
| 1 Fixed condenser, 0.0002 mfd.
Graham-Farish | |
| | (Dubilier, Ferranti, Forno, Goltone, Hellesau,
Igranic, Loewe, T.C.C., Telsen, Wego.) |

- | | |
|---|---------------|
| 1 Toggle Switch, make and break | Bulgin S.80 |
| 1 Toggle Switch, three-point | Bulgin S.87 |
| 1 Toggle Switch, single pole change-over
(British Radiophone, Claude Lyons.) | Bulgin S.81 |
| 1 Dial Lamp, 2 volts | Bulgin Type H |
| 1 length Screened Sleeving
(Goltone, Lewcos.) | Harbros |
| Wood Panel, 9in. x 10in. 3-ply | |
| Plymax Baseboard, 10in. x 10in. ¼in.
(Or metal chassis, Magnum) | Peto-Scott |
| 1oz. So. 22 Tinned Copper Wire, 6 lengths Systolox,
Wood, Wire, etc. | |
| Screws:—8 ¼in. No. 6 R/hd.; 30 ¼in. No. 4 R/hd.;
2 ¼in. No. 4 C/sk.; 4 ¼in. No. 4 C/sk.; 6 ¼in.
No. 4BA R/hd. | |
| Loud Speaker | W.B. |
| Valves:—1 Mullard PM42M; 1 Mazda HL2; 1 Mazda L2;
1 Mazda PD220 | |

News of the Week

Current Events in Brief Review

Six Million by Christmas ?

THE opening of the Olympia Radio Exhibition on Tuesday, August 15th, will mark the opening of a national campaign to secure half a million more listeners by the end of the year. It is hoped to reach the six million mark by Christmas.

For the Poor

WITH a kindly thought for the listener who is unable to afford a programme paper, the Leipzig broadcasting authorities give a short *résumé* of the day's programme after the midday news bulletin. A survey of the evening programme is given at 7 p.m. (B.S.T.).

Do Women Prefer Men ?

THE feminine population of France is gazing uneasily at the steady advance of the lady announcer in Europe. According to our Paris correspondent, even the most feminist of listeners prefer the manly voice at the microphone. Certain it is that many a wife shudders at the thought that her husband may spend his leisure hours, even if at home, listening to the voice of another woman.

"Ultra Shorts" at Hastings

ULTRA short-wave enthusiasts on the South Coast will have an opportunity to test their receivers on Sunday next, August 6th, when, between 11 a.m. and 1 p.m., 5-metre transmissions will be carried out from North Seat, the highest point in the district, using the call sign G2AX. Reports are asked for by Mr. Blackburn, 11, Sea Road, Bexhill-on-Sea.

Marconi's Micro-Wave Tests

MARCHESE MARCONI has started on a new cruise in his steam yacht *Eletra* for the purpose of carrying out further experiments in the transmission and reception of waves of less than one metre in length. Last year the Marchese transmitted and received micro-wave signals over the record distance of 168 miles.

Marconi's v. Philips

MR. JUSTICE MAUGHAM, in the Chancery Division last week, dismissed the action in which Marconi's Wireless Telegraph Company, Ltd., sought to recover damages from Philips Lamps, Ltd., for alleged infringement of Patent No. 13636 of 1913 granted to the plaintiffs and Charles Samuel Franklin.

The patent claimed for "a receiving system for electrical oscillations which contains a valve for magnifying the oscillations, and which is so arranged that the circuit in which are set up the magnified oscillations reacts on the circuit in which occur the oscillations to be magnified."

The Judge held that the patent was a valid one, but that it had not been infringed by the defendants, who were awarded four-fifths of the general costs of the action. The total costs exceeded £30,000.

A Voice Departs

THE familiar voice of one of the speakerines at Radio Paris has left the air for ever, its owner having entered a convent to become a Little Sister of the Poor. She was the announcer who broadcast most of the advertisements in the intervals in the Radio Paris programmes.

Talking Again

WELCOME to "Le Speaker de Radio Toulouse" who has returned to the microphone after his first interval of silence since 1925. M. Jean Roy, this popular announcer,

The Photo Cell Show

THE special exhibition at the Science Museum, South Kensington, of photo-electric cells and their practical applications, described in *The Wireless World* of March 31st last, is to remain open till the end of September in consequence of public interest in the display.

While the essential features of the exhibition remain unchanged, there are several interesting additions. Prominent among these is a "Chart Analyser" lent by the Post Office Engineering Research Station. The charts to be ana-

these records are monitored by a photo-electric cell.

The automatic door-opener is now arranged so that the period of remaining open depends upon the speed at which a person approaches. It remains open long enough to allow a person to pass through slowly in comfort, yet it is not kept open unnecessarily long for a quicker walker.

The "Blancometer" also makes its appearance. This instrument accurately measures the departure from a standard whiteness of a surface such as paper.

Anti-static League

DETERMINED to put an end to interference from trolley buses, Nottingham residents have formed the "Radio Interference Prevention League." Membership is free, and a public meeting is to be called in the near future to decide what action shall be taken to overcome the prevailing disturbance caused by the corporation buses. The hon. secretary is Mr. H. P. Lynn, 32, Bath Street.

Listeners on the "Rock"

THERE are now over 700 licensed listeners at Gibraltar. The annual licence fee of 10s. is collected by the Colonial Office. It, however, is not disclosed how this yearly windfall of some £350 is spent!

Interference from land and ship morse stations is a continual source of trouble on the "Rock," but Daventry and most Continental stations are well received on ordinary valve sets.

OLYMPIA RADIO SHOW

Tuesday, August 15th, to Thursday, August 24th.

NEXT WEEK'S ISSUE IS THE FIRST OF
THREE SPECIAL NUMBERS.

AUG. 11th.—Guide to the Show.
What to look for and where to look. A valuable "see-at-a-glance" forecast, with a full list of Stands and a pictorial plan.
The issue will also contain full constructional details of *The Modern Battery Four*—a battery set with "mains" performance.

AUG. 18th.—Trend of Design.
The year's progress as revealed at Olympia. Well-illustrated articles discussing the new sets, components and accessories.

AUG. 25th.—Complete Show Report.
A full description, prepared by *The Wireless World* Technical Staff, of new apparatus shown by each exhibitor.

cer, claims to hold the world's record for the number of hours a man has spoken into a microphone. Since April, 1925, he has hardly missed a programme until the broadcasting station came to grief a few weeks ago, and, according to the Paris correspondent of *The Daily Telegraph*, his total of hours spoken is calculated at nearly 22,000.

"Lyons-Tramoyes"

A SILENT revolution is taking place in French broadcasting. One by one the giant stations scheduled under the Ferrié Plan are taking shape. On July 22nd the foundation-stone was laid for the 100 kW station at Lyons to replace Lyons la Doua. This "Lyons-Tramoyes" transmitter, as it will be called, occupies an excellent site dominating the entire region of Dombes.

Happy Tangier

NOW that the French have joined the ranks of paying listeners, there are few spots left in the Old World wherein citizens can tune in at no cost to themselves. One of the last remaining paradises must surely be Tangier: Across the Mediterranean, listeners on Gibraltar pay 10s. a year; in Spanish Morocco they pay (or *should* pay) 2s. 6d. a year, and in French Morocco the annual fee is about 12s. 6d. But in Tangier there is no licence fee, and there is no need to operate receivers quietly or to conceal or disguise your aerial.

lysed are records of the alternating periods of "use" and "idleness" of certain pieces of apparatus employed in automatic telephony;

FIVE-METRE TESTS ON SNOWDON

MOUNT SNOWDON, 3,570 feet high, is to be used as an ultra-short-wave transmitting base on Saturday, August 12th, when Messrs. H. L. O'Heffernan (G5BY) and H. E. Smith (G6UH) will operate two transmitters and receivers in an attempt to beat all records in ground-to-ground communication with ultra-short-waves. Both phone and modulated C.W. will be used.

Every effort will be made to effect two-way contacts, and all transmitters desirous of arranging schedules are asked to write immediately to G5BY at 2, Chepstow Road, Croydon, Surrey, stating their proposed location, type of transmission, and times of operation. All owners of ultra-short-wave receivers will be cordially welcomed as participants in the test, and we understand that to encourage good reports the experimenters are offering a souvenir award for the best report from Northern Ireland or the Irish Free State and a similar award for the best report from either England, Scotland, Wales, or the Isle of Man. The distance at which the transmission is received together with the complete-

ness of the log submitted will determine the award.

Transmitting and receiving periods (except when two-way contacts are taking place) will be as follows:—

Transmission: 0-10, 20-30, and 40-50 during each hour.

Receiving: during the intervening periods.

Both transmitters on Snowdon will normally operate simultaneously (G5BY on 60 m.c. and G6UH on 56 m.c.).

The following vantage points are actually visible from the summit of Snowdon:—

	approx. Miles Distant
Wicklow Hills I.F.S. ...	100
Galloway Hills, Scotland ...	140
Isle of Man (Snae Fell) ...	83
Cumberland Fells ...	100
Peak of Derbyshire ...	100
St. David's Head, S. Wales ...	100
The Wrekin, Shropshire ...	70
Lancashire & Yorkshire Hills 70/100	

As Snowdon is so near to the Irish Sea, the whole of Ireland is considered to be very favourably situated for reception.

Fuller particulars of the test can be obtained on communication direct with Mr. H. L. O'Heffernan, 2, Chepstow Road, Croydon, Surrey.

LABORATORY TESTS

NEW RADIO PRODUCTS REVIEWED

PLEW ANTI-FADING UNIT

A UNIT has been placed on the market by Messrs. Plew & Dear, of 22, George Street, Hanover Square, London, W.1, for adding automatic volume control to an existing receiver. This anti-fading unit interconnects the anode of the detector valve with the screen-grids of the H.F. stages in such a manner that the screen voltage of the latter is derived from the detector anode supply. Owing to the presence of a high value resistance in the circuit and to the use of anode bend detection, the detector anode voltage, and hence the H.F. screen voltage, drops with an increase of signal input. The amplification thus varies inversely as the signal strength.

The supreme merit of the system is its simplicity, for it is merely necessary to break the detector anode circuit and insert the unit, and to feed the screen-grids from the terminal provided instead of from their usual point. Should the receiver employ grid detection, it is, of course, necessary to change to anode bend rectification, but this usually means a very simple alteration. This system of A.V.C., of course, offers no protection against overloading the H.F. stages by a strong signal, so that for local reception it is hardly possible to dispense with the ordinary volume control. Moreover, it may not always be considered desirable to use an anode bend detector.

Nevertheless, the unit will afford a measure of automatic volume control, and will greatly reduce the effects of fading on distant stations. Tested with a 1-H.F. set it functioned quite satisfactorily; although some reduction in sensitivity was evident in this particular case, doubtless due to the change to anode bend detection. The unit

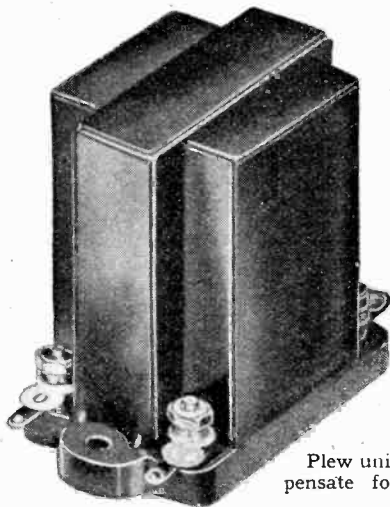

Plew unit to compensate for fading.

can be confidently recommended as providing a simple means of reducing fading, and it will be found most readily applicable to those types of sets which already incorporate an anode bend rectifier and which have a volume control operating on the screen-grids of the H.F. valves.

The unit is priced at 10s.

E.D.C.C. CAR RADIO H.T. CONVERTER

THIS small rotary converter made by the Electro-Dynamic Construction Co., Ltd., Devonshire Grove, London, S.E.15, has been designed especially for use with car

radio receivers. The motive power is taken from the car starter battery, and on full load amounts to about 15 watts, so that with a 12-volt battery it requires a current of 1 1/4 amperes approximately. The rated output from the machine is 220 volts D.C. at a maximum load of 40 mA.

Particular care has been taken in the con-

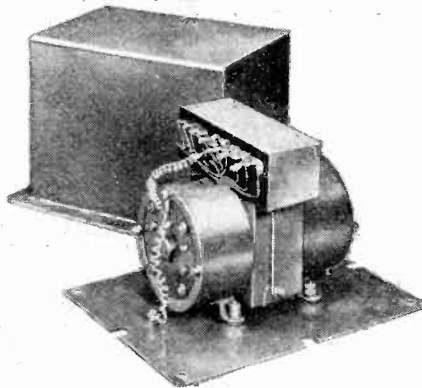

Electro-Dynamic H.T. Converter for motor car radio sets.

struction to render the converter as fool-proof as possible, and very little attention is necessary to ensure a trouble-free service. Since the converter will be subjected to a certain amount of vibration, all nuts are either secured by the addition of locking nuts or sprung washers and thick rubber pads are interposed between the converter and its supporting plate. The general assembly is such that even on badly pot-holed roads the machine will ride comfortably and without undue vibration.

The converter embodies a double-wound armature running in ball bearings and having a commutator at each end. The brushes, which are of the box type, are self-compensating for wear, and, being of generous size, should require very little attention. Maintenance is thus limited to occasional lubrication of the bearings. A smoothing unit, which effectively removes all trace of ripple from the H.T. supply, is incorporated.

Measurements made with the specimen converter sent to us, which, incidentally, is wound for a 12-volt supply, show that an efficiency of over 50 per cent. is obtained on full load—a most satisfactory figure in view of its small dimensions.

The table gives in concise form the results

Input.			Smoothed D.C. Output.			Efficiency per cent.
Volts.	Current Amps.	Watts.	Volts.	Current mA.	Watts.	
12	0.340	4.1	306	1.5	0.46	11.1
12	0.425	5.1	297	5.0	1.48	29.0
12	0.550	6.6	285	10.0	2.85	43.2
12	0.670	8.0	273	15.0	4.1	51.3
12	0.792	9.5	260	20.0	5.2	54.8
12	0.925	11.1	248	25.0	6.2	55.8
12	1.06	12.7	235	30.0	7.0	55.5
12	1.19	14.3	224	35.0	7.84	54.8
12	1.32	15.8	216	40.0	8.63	54.6

of our measurements with various output loads.

The converter is totally enclosed in a

waterproof and dustproof sheet-iron container measuring 8 1/2 in. x 6 in. x 6 1/2 in., which is intended to be sunk into the floor of the car so that the cover plate is flush with the floorboards.

Models are available for either six- or twelve-volt lighting sets, and the price is £6 4s. complete.

HAYNES VOLUME CONTROL

MADE by Haynes Radio, 57, Hatton Garden, London, E.C.1, this potentiometer has been designed to give noiseless control of volume under all conditions of working. It was developed in the first instance for use in their receivers, but it is now available as a separate component.

Silent operation is obtained, it is stated, by ensuring a uniform contact throughout between the moving brush and the resistance, and further, by guarding against lateral movement of the turns as the contact arm passes over them.

The use of a very thin former giving a small area of contact which, in conjunction with a suitably shaped contact brush, has achieved the desired silence in operation. This we are able to confirm by tests, for the specimen sent to us proved entirely satisfactory when used either in H.F. or L.F. circuits.

A light stirrup-type contact isolated electrically from the spindle is employed, this method of construction not only simplifies ganging, but enables the control to be connected with the variable contact "live" to H.F. without adding appreciable capacity to the circuit or introducing undesirable complications.

This volume control is made in a wide range of values up to 50,000 ohms, with or without a snap-action switch, which item,

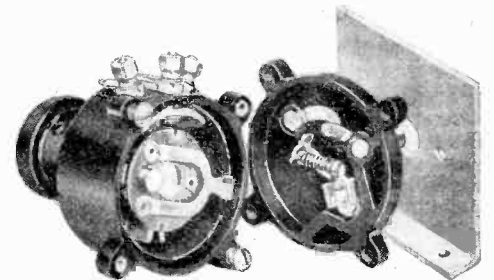

Haynes volume control with switch cover removed.

when fitted, is embodied in the back cover-plate. The resistance is entirely enclosed in a moulded bakelite case, and the workmanship is of a very high standard. The price is 5s. in all values. Tapered or graded resistances are available at an extra charge of 1s., and the addition of the switch costs 1s. 9d. A fixing bracket is included.

Willings Press Guide, 1933 (60th Annual issue), containing particulars of over 6,000 newspapers and periodicals in Great Britain, and a list of the principal Colonial, Dominion, and foreign publications, together with their London addresses. In addition to the main alphabetical index of British publications they are also classified under the special subjects with which they deal, and there is a geographical list of provincial journals. Pp. 502 + viii. Price 2s. 6d.

Broadcast

Thanks to Lucerne

HOWEVER much we may grumble at the Lucerne Plan, we ought to take off our hats to Lucerne, for it is to Lucerne, indirectly, that we owe the appointment of Mrs. Giles Borrett, Britain's first woman announcer.

The innovation has been due to the initiative of Sir Charles Carpendale, the Controller of the B.B.C., who, during his stay at Lucerne for the Conference, was impressed by the popularity of women announcers on the Continent.

"A Man's Job"?

On his return Sir Charles sought and found the right person to fill a similar rôle at Broadcasting House. Several fair "possibles" were canvassed, but the majority seemed to feel that announcing was "a man's job"—why, I don't know.

Women seem to take quite naturally to announcing—when at home.

Listening to Television

I WONDER whether many readers without televisions listen to the "sound" side of the B.B.C. television programmes?

With all respect to television, I often find that these programmes yield a maximum of entertainment even on a "blind" set.

Rochdale is Watching

Mr. Robb, Television Programme Chief at Broadcasting House, was visited last week by an emissary of a big television colony in Rochdale, where, it appears, television is all the rage at the moment.

Despite the distance from the television transmitter at Brookmans Park, the Rochdaliens get very good results indeed, though atmospheric and heterodynes are inclined to break up the image at times.

A Televisionary

By the way, Rochdale claims to have the first public televisionary. This enterprising person has rigged up a mobile van as a television studio and theatre. For a small sum any member of the public may be "televised"—i.e., have his or her features recorded on a wax disc.

When the disc is full the results are projected on to a screen to an audience which pays fourpence a seat.

There should be a good opening for this sort of entertainment at the seaside.

Fight in a B.B.C. Studio?

TO celebrate the first anniversary of B.B.C. television programmes, which occurs on August 22nd, it is suggested that a real boxing match should be staged in Studio Bb. Len Harvey and other prominent boxers may attend, if they do not participate.

Black Eyes

A running commentary would be given for the benefit of listeners without televisions, but the real thrill would be reserved for "lookers-in." To "receive" the first black eye by wireless would be a coveted honour. No doubt disfigurements of this sort would immediately be touched up with burnt cork in order that the maximum effect would be obtained on the ether. The cork would be concealed in the traditional lump of red steak



THE NEW VOICE. Mrs. Giles Borrett, who has just been appointed an announcer at Broadcasting House. As Sheila Stewart she has taken part in a number of radio plays.

By Our Special Correspondent

The Colonel Reconnoitres

I HEAR that Colonel Dawnay, who takes charge of the Output Branch of the B.B.C. activities on September 1st, has now visited headquarters for reconnaissance purposes.

There is no doubt that things are to be "pepped up" this coming winter. Let us hope that the machinery will not get too hot.

All or Nothing

EVEN now the title deeds of the site chosen for the Northern Ireland Regional station are not in the hands of the B.B.C. Apparently, as in the case of all the other station sites, the Corporation insists on owning the soil right down to the earth's central fires, just as it owns the Appleton and Heaviside Layers above.

Minerals?

The owners of the ground are dubious about parting with the mineral rights. This looks like an *impasse*, for the B.B.C. would never consent to mining operations beneath its own transmitters.

B.B.C. Dance Band in Public

HENRY HALL and the B.B.C. Dance Orchestra will be making their first stage appearance at the Olympia Radio Exhibition. The entertainment will be made up of a variety programme and a revue. The variety programme will be produced by John Sharman, who tells me that he is planning a grand *ensemble* with the B.B.C. Dance Orchestra as a background to a galaxy of radio stars in a final scene which should be memorable in the history of radio variety.

Variety Favourites

On the opening day of the Exhibition, August 15th, and on August 18th, the variety programme will be given from 6.30 to 7.45 p.m. and the revue from 8.25 to 9.40 p.m. On other days during the run of the show, the revue will be given in the earlier and the variety in the later period.

Brevities

The artistes in the variety will include Norman Long, Mamie Soutter, Horace Kenney, the Houston Sisters, and also Jass and Jessie. In the second week, the bill will include Flotsam and Jetsam, Clapham and Dwyer, the Carlisle Cousins, Julian Rose, Laurie Devine, and Sydney Baynes with his orchestra.

The Revue

The revue is devised and produced by John Watt and Harry Pepper, and among the leading artistes will be Anona Winn and Paul England.

The Theatre

The specially constructed theatre will occupy the Minor Hall at Olympia and hold an audience of 2,000. All or part of the programmes given each evening will be re-broadcast throughout the Exhibition by loud speakers, which will also distribute some of the ordinary programmes from Broadcasting House.

The Cafeteria

"IF we 'ad 'am," said the soldier to his pal, as they reached their billet, "we could 'ave 'am and eggs, only we ain't got no eggs."

Similar thoughts are rushing through the minds of some of the patrons of the cafeteria in Broadcasting House. The "hours" have been extended, but this does not apply to the licence, for the simple reason that there isn't one.

A Twenty-four Hour Day

The cafeteria, however, is now a day and night concern, open at all times to cope with the Empire broadcasting arrangements under which artistes are generally to be found in the building throughout the twenty-four hours. Snacks are very popular at 3.0 a.m. when the Canadian programme ends.

The Wrong Voice

THE great French "O.B." describing the *Tour de France* cycle race was notable for several amusing incidents.

During the broadcasting from *Radio-Paris* the Post Office lines got mixed. According to my informant, the thrilling account was suddenly cut off and a strong Southern voice was heard saying: "Send a dozen more bottles immediately!"

Opera from the Continent

OPERA broadcasts continue to furnish programme items, even in the dog days of the holiday season. Following the relay of Act II from Salzburg, on August 7th, of "Orpheus and Eurydice," Munich will provide British listeners on August 8th with a relay of Act II of "The Magic Flute."

Trying to Split Hairs

THE B.B.C. have had a letter from a West Country listener who, while congratulating them on their success in synchronising West and London National transmitters, states that he cannot separate the two when he wants to.

READERS' PROBLEMS

Anode Feed Circuits

THE making of initial adjustments to a receiver fitted with A.V.C. is greatly simplified by the inclusion of a meter in the anode circuits of the controlled valves (those valves of which the grid bias is regulated automatically by the control system).

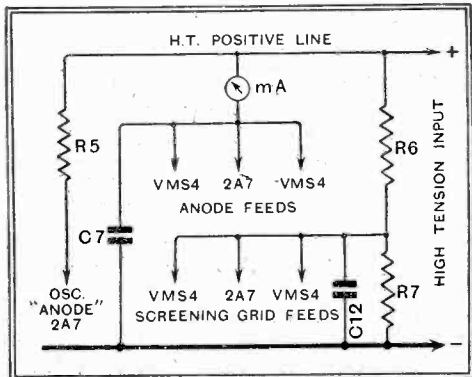

Fig. 1.—Dissecting the H.T. feeds for the earlier stages of the New Monodial receiver.

A reader who is about to build the New Monodial Super wishes to adopt this plan, but is not quite clear as to how the meter should be connected in order that it may read the total anode current of the controlled valves (H.F. amplifier, first detector, and I.F. amplifier). We are asked to give a circuit diagram explaining this matter.

As stated in the second part of the descriptive article, a better indication of what is happening in this particular case is afforded by the connection of a meter in the anode circuit of the double-diode-pentode second detector valve, which is also controlled automatically. In this respect the new set differs from those including the circuit arrangement with which we have of late become familiar.

However, it may in certain circumstances be an advantage to obtain a reading of the total anode current of the first three valves, or of individual valves, and we give in Fig. 1 a simplified skeleton diagram showing the anode and screening grid feed system, etc.; the position of a measuring instrument is indicated.

A.V.C. Increases H.T. Voltage

A QUERIST, who has just fitted automatically ambitious A.C. superheterodyne receiver (which he describes in detail) is puzzled at finding that the anode current of the second I.F. amplifier, which is not controlled automatically, tends to rise when a strong signal is received. Otherwise the control system—and the set generally, for that matter—work excellently and according to plan in every respect. We are asked to say what may be deduced from this change in current.

It is possible that the second I.F. valve, of which the anode current tends to rise, is over-biased or overloaded, and so anode bend rectification is taking place. We advise our querist to check the operating conditions of the valve, and particularly to make sure that its grid bias is not exces-

sive. But it is more likely that the effect described is quite normal and harmless. When a strong signal is received a considerable reduction in the current consumed by the controlled valves takes place, due to the action of the A.V.C., and so there is a general rise in H.T. voltage. This rise may be quite enough to cause a perceptible increase in the current consumed by the uncontrolled second-stage I.F. amplifier.

Without an Earth

THE user of an A.C. mains set has noticed that signals are slightly, but quite definitely, increased in strength as a result of removing the earth lead. It is realised that an earth terminal is not fitted merely as an ornament, and we are asked for comments on the unusual behaviour of the receiver.

As is well known, a mains-operated receiver is earthed more or less effectively through the mains themselves, and usually quite good signals are obtainable without a separate earth connection.

But an actual improvement in strength, as a result of removing the earth wire, is distinctly unusual. Occasionally it is found to be due to misganging of the aerial circuit; by disconnecting the earth wire, the amount of aerial capacity transferred to the first tuned circuit is sometimes reduced appreciably, and it may be that louder signals are due merely to a chance improvement in circuit alignment. This is easily checked by readjustment of the input circuit trimmer.

Again, it is not impossible that there is more incidental reaction when operating the set without an earth.

A.V.C. on D.C.

A READER, who wishes to adapt his Monodial D.C. Super for automatic volume control suggests tentatively that it might be possible to use the method of control described for the A.C. version of this set. If this scheme is impossible, he asks for suggestions.

We fear that it will be impracticable to adapt the method of control used in the A.V.C. Monodial to a D.C. set, if only because the H.T. voltage available will be inadequate. It is suggested that the simplest way of making this addition would

The Wireless World INFORMATION BUREAU

THE service is intended primarily for readers meeting with difficulties in the construction, adjustment, operation, or maintenance of wireless receivers described in *The Wireless World*, or those of commercial design which from time to time are reviewed in the pages of *The Wireless World*. Every endeavour will be made to deal with queries on all wireless matters, provided that they are of such a nature that they can be dealt with satisfactorily in a letter.

Communications should be addressed to *The Wireless World* Information Bureau, Dorset House, Stamford Street, London, S.E.1, and must be accompanied by a remittance of 5s. to cover the cost of the service. The enquirer's name and address should be written in block letters at the top of all communications.

THESE columns are reserved for the publication of matter of general interest arising out of problems submitted by our readers. Readers requiring an individual reply to their technical questions by post are referred to "The Wireless World" Information Bureau, of which brief particulars, with the fee charged, are to be found at the foot of this page.

be to employ a Westector (Westinghouse copper oxide H.F. rectifier) as a second detector, and to convert the existing second detector into a first-stage L.F. amplifier. The Westector would be connected in the manner advised by the manufacturers, and it would be best to control the signal-frequency H.F. valve and the first detector; in order that the control may be effective the latter valve should be replaced by one of the variable-mu type. It is not recommended that the I.F. stage should be controlled automatically, as this valve would be overloaded by a strong signal.

Out of Centre

DESCRIBING the behaviour of his moving-coil loud speaker, a reader states that quality is quite good at low volume levels, but, on increasing strength, an unpleasant "comb and tissue paper" effect becomes noticeable. This is not a case of overloading the instrument, as it is designed to deal with more than twice the rated output of the valve which feeds it.

Our correspondent is probably correct in coming to the conclusion that this is due to imperfect centring of the moving coil, or possibly to warping of the coil former. For large movements of the coil (corresponding to full volume) it is probably rubbing against the sides of the magnet gap.

It is rather difficult to comply with the request that we should give full instructions for re-centring the coil. Various "tricks of the trade" are in common use, but few of them are universally applicable. We sug-

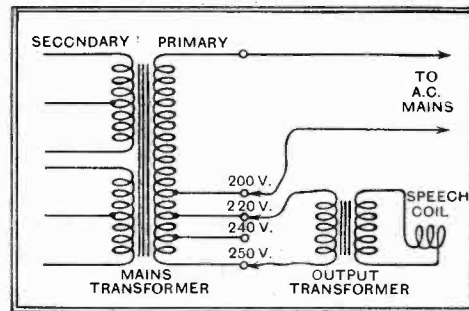
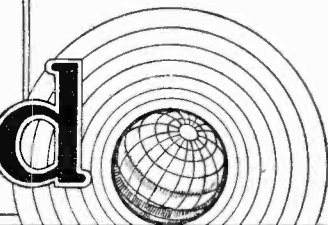
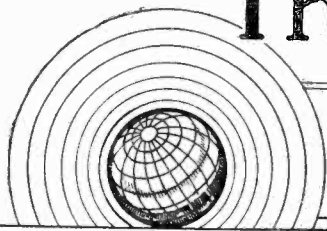

Fig. 2.—A source of low-voltage A.C. for testing purposes is available across the primary tapings of a power transformer.

gest that the operation is best done by making slight experimental alterations in the position of the coil after slackening off the screw which holds the centring "spider." This operation needs a good deal of patience, and should be carried out while the loud speaker is reproducing a steady note of low pitch. A fairly well-known method of obtaining this note is illustrated diagrammatically in Fig. 2. Here the necessary A.C. voltage is obtained from the tapings of the power transformer which feeds the set; various voltages are obtainable. Of course, if this method be adopted, the load on the power equipment should be maintained by joining together the leads which were originally connected to the primary.

The Wireless World

THE PRACTICAL RADIO JOURNAL
23rd Year of Publication



No. 728.

FRIDAY, AUGUST 11TH, 1933.

VOL. XXXIII. No. 6.

Proprietors: ILIFFE & SONS LTD.

Editor:
HUGH S. POCOCK.

Editorial,
Advertising and Publishing Offices:
DORSET HOUSE, STAMFORD STREET,
LONDON, S.E. 1.

Telephone: Hop 3333 (50 lines).
Telegrams: "Ethaworld, Watloo, London."

COVENTRY: Hertford Street.

Telegrams: "Cyclist, Coventry." Telephone: 5210 Coventry.

BIRMINGHAM:

Guildhall Buildings, Navigation Street, 2.
Telegrams: "Autopress, Birmingham." Telephone: 2970 Midland (3 lines).

MANCHESTER: 260, Deansgate, 3.

Telegrams: "Iliffe, Manchester." Telephone: Blackfriars 4412 (4 lines).

GLASGOW: 26B, Renfield Street, C.2.

Telegrams: "Iliffe, Glasgow." Telephone: Central 4857.

PUBLISHED WEEKLY. ENTERED AS SECOND CLASS MATTER AT NEW YORK, N.Y.

Subscription Rates:

Home, £1 1s. 8d.; Canada, £1 1s. 8d.; other countries abroad, £1 3s. 10d. per annum.

As many of the circuits and apparatus described in these pages are covered by patents, readers are advised, before making use of them, to satisfy themselves that they would not be infringing patents.

CONTENTS

	Page
PROGRAMMES FROM ABROAD, pp. 1-XXIV	
Editorial Comment	85
Modern Battery Four	86
Unbiased	91
Plan and Guide to the Exhibitors at Olympia	92
What to See at Olympia	95
Extension Loud Speakers	108
News of the Week	111
Practical Hints and Tips	112
Broadcast Brevities	113
Correspondence	114
Cossor 3456 Receiver	115
Readers' Problems	116

EDITORIAL COMMENT

Programmes

Why Kill the Goose . . . ?

WHEREVER wireless is discussed we may expect to hear criticism of the programmes put out by the B.B.C.—criticism occasionally intelligent, but most often sheeplike in its repetition of opinions expressed by some unfortunate newspaper contributor who, having exhausted other topics, falls back at regular intervals upon a criticism of the programmes as a "stop-gap." Probably the severest critics of all are to be found in the radio trade, manufacturers being ever ready to criticise the programmes and blame them, in times of prosperity as well as times of depression, as being responsible for restricting public interest.

Those who depend for their livelihood on the sale of broadcast receivers and apparatus should surely be the last to encourage dissatisfaction amongst the public with the quality of broadcasting. What should we think if some seaside resort advertised to attract visitors on the lines that the place was not worth coming to anyway? Yet this, in fact, is what the wireless manufacturer is doing when he hopes to sell his products but at the same time decries the B.B.C. programmes.

Why Decry the Programmes?

Is there any real justification for this persistent attitude of protest against the efforts of the B.B.C.? Is it not a fact that in no country in the world can one expect better entertainment or better quality transmission than we get here? There may, perhaps, be insufficient variety in the matter of alternative programmes, and a host of little things to grumble about but mostly insignificant in comparison

with the excellence of the transmissions as a whole. Sometimes we are inclined to think it might be good for the critics if the B.B.C. transmissions were to cease temporarily, when their real worth and importance would then be appreciated for the first time.

Let us be proud of the programmes we have got and impress others with their value. In doing so we do not deprive ourselves of the right to try to improve still further on their excellence. Above all, let the representatives of the Radio industry itself cease from public depreciation of that which alone can sell their wares.

The Show

Forecast and Guide

TUESDAY of next week is the date of the opening of the annual Radio Show at Olympia, and in this issue we include a plan of the Exhibition with a key to the location of stands. A general guide is provided in the form of a forecast of items of outstanding interest in the various classes of exhibit. With a week-end available in which to study this issue, we hope it will be found helpful to those of our readers who will be visiting the Show next week, whilst this number, taken in conjunction with the two further special numbers of *The Wireless World* dealing with the Show, should prove a useful record of the Exhibition equally valuable to those who may not have the opportunity of making a personal visit.

Visitors to Olympia will be interested to know that on our stand, Number 7, we shall be exhibiting the New Monodial Super, the "Two Unit Portable," a battery set recently described, and the Modern Battery Four, a description of which is included in this issue.

The Wireless World

MODERN BATTERY FOUR

An Economical Straight Set with "Mains" Performance

By W. T. COCKING

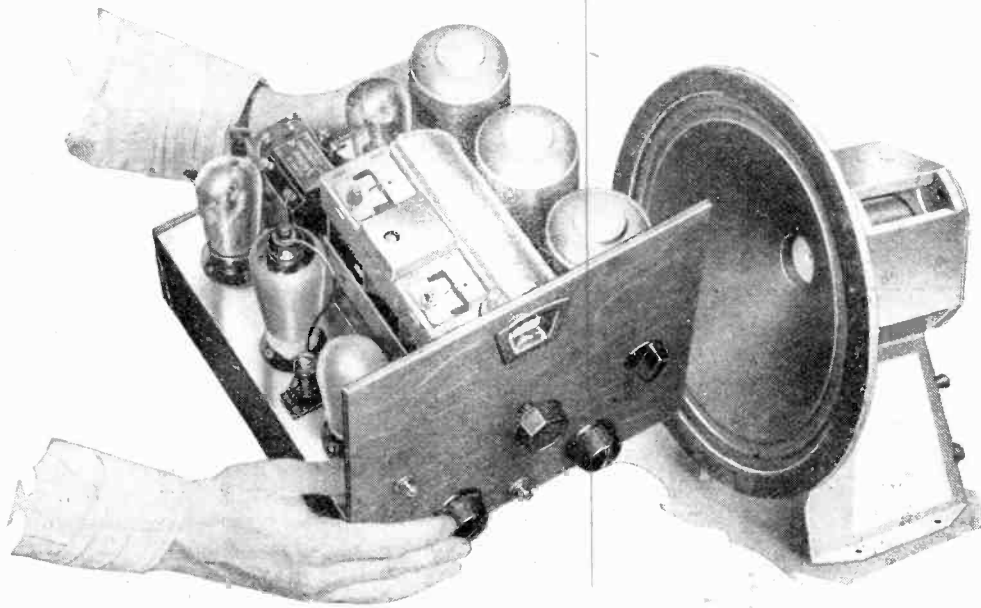

THE advent of the Class "B" output stage has put all other systems out of court in any economical battery receiver, for in the matter of volume it puts the battery user on a par with those fortunate enough to possess a mains supply. Although Class "B" amplification has been thoroughly dealt with in *The Wireless World*, there is still some misapprehension as to its capabilities, and before proceeding with the details of the new receiver it may be well to explain the characteristics of this type of output stage.

The ordinary, or Class "A," output stage consumes a fixed amount of power

whatever input is applied to it. Thus a stage rated for an output of 1 watt will require over 3 watts of battery power for its operation even when a high-efficiency pentode-type valve is employed. This amount of power, moreover, is consumed whether the valve is actually delivering 1 watt to the speaker, or giving no output at all during a pause in the programme.

With Class "B" operation, however, the power consumed varies according to the signal applied to the valve, and during the absence of a signal, a stage rated for an output of 1 watt will require little more than 0.25 watt battery power. When it

is actually delivering 1 watt to the speaker, of course, the battery power is much greater than 1 watt, for the efficiency is by no means 100 per cent. The full output, however, is normally required only on loud passages of music, and during the greater portion of the time the output stage is underloaded, so that the *average* power required may be only about 1 watt for a maximum output of 1 watt.

There can thus be no doubt as to the economy of Class "B" output systems; the question of quality, however, is by no means unimportant, and deserves careful attention. When each type of output stage is delivering its maximum rated

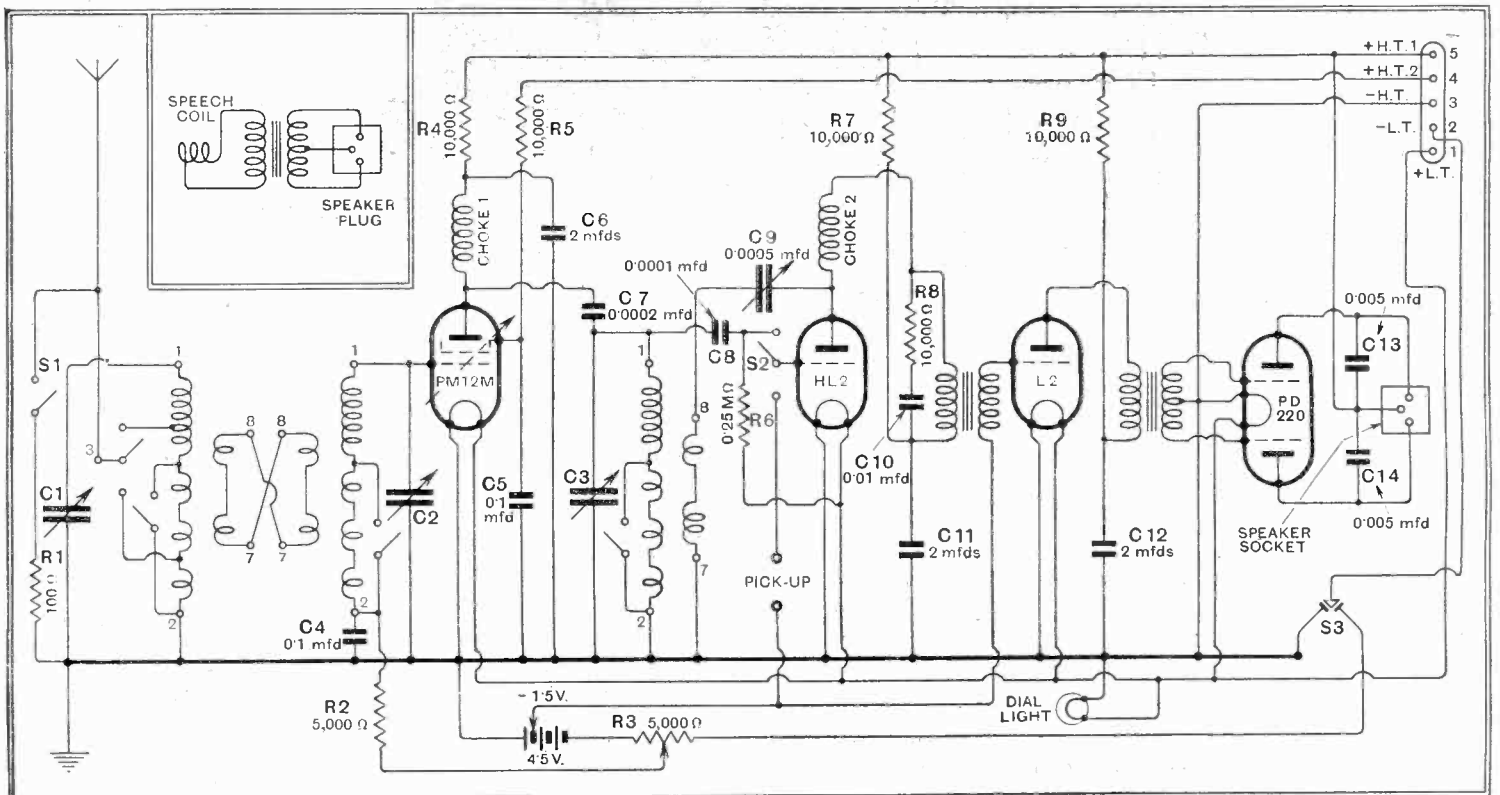

Fig. 1.—The complete circuit diagram of the new battery set. An adequate range of volume control on all signals is secured through the combination of the bias control R3 and the local distance switch S1.

Modern Battery Four—

output, there is no difference in the quality, since the rating in each case is based upon 5 per cent. distortion. As the signal input to the output stage is decreased, the distortion naturally falls, but here we find a difference between Class "A" and Class "B" stages. With the former the distortion falls rapidly as the input is reduced, and it is soon negligible; the result is that, when the stage is correctly operated, distortion can only be detected on the very loudest passages of music. With a Class "B" stage the distortion also falls as the input is reduced, but not so rapidly as with Class "A," and it is quite possible for it not to fall below some 2 per cent. until the input is minute. A Class "B" output stage, therefore, is not as good from the quality viewpoint as a valve operated in Class "A," when both give the same maximum output; the Class "B" stage, however, will require less power to operate it.

The practical result of this is that in cases where there is plenty of power available, as in mains sets, a Class "A"-type output stage is preferable to Class "B." An output of at least 1 watt is necessary for a satisfactory performance, however, and this is unobtainable economically with an ordinary battery-operated output stage. If we assume that an average battery power of 1 watt is as much as can be normally used, we can only obtain from 100 to 200 milliwatts with a Class "A" arrangement for a maximum distortion limit of 5 per cent., whereas with Class "B" we can have about 1 watt. An output of 100/200 milliwatts is so small that where such a stage is used it is habitually operated in an overloaded condition in order to obtain adequate volume. As a result, the distortion is far above 5 per cent. The use of Class "B," therefore, will lead to a great improvement in the quality of

reproduction. Although Class "B" is not quite as good as Class "A" when each system is rated for the same maximum output, it is very definitely superior to Class "A" when the comparison is based upon equality of the power drawn from the H.T. supply. It will thus be clear that the Class "B" system enables the battery user to obtain volume equivalent to that of a mains-operated set with better quality than he has previously experienced, even although that quality may not be quite as good as that given by the best mains receivers.

The amplification obtainable from a Class "B"-type valve is less than that

given by a pentode, and this is accentuated by the necessity for feeding it through a step-down, rather than the usual step-up, transformer. A set with two L.F. stages, therefore, is now more likely to include two L.F. transformers than one transformer and one resistance coupling.

IRON-CORE tuning coils and class B amplification represent the chief developments of recent months and their correct use gives vastly improved results. In the receiver described in this article, they are utilised to the full, and as regards selectivity, volume, and quality, the performance is greatly superior to that of any simple battery receiver more than six months

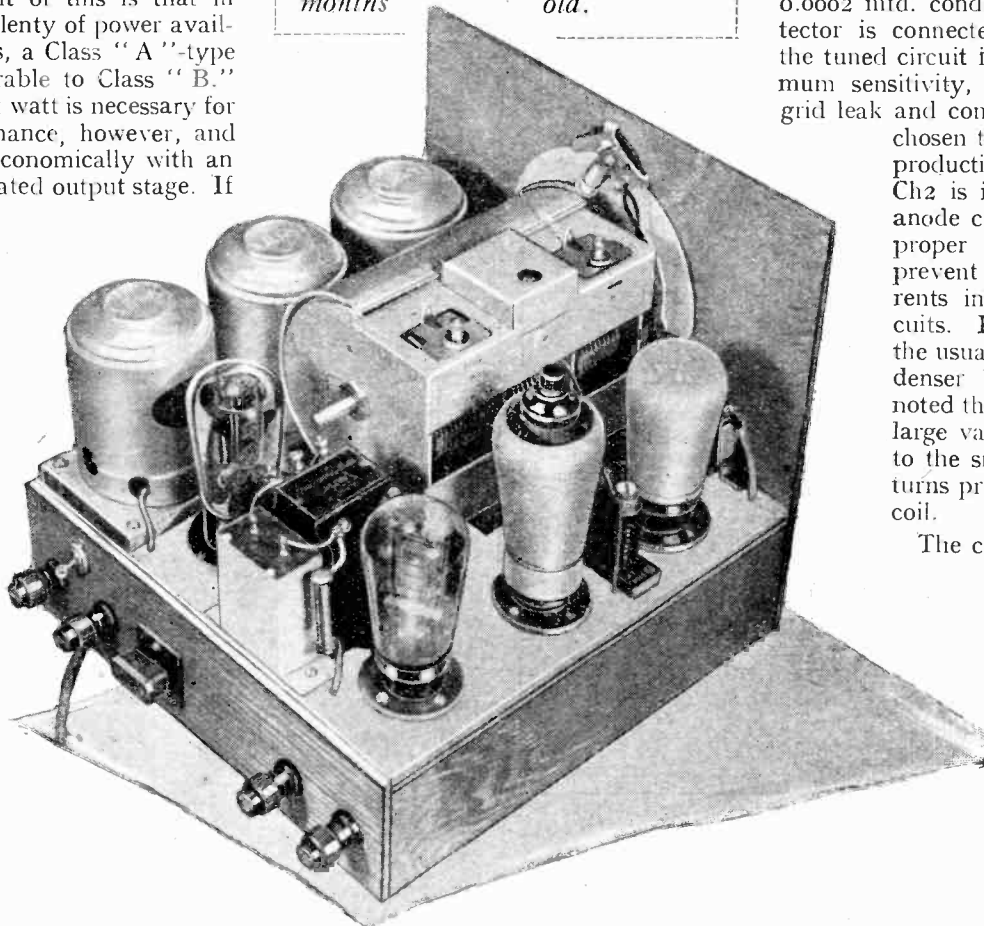

The layout is straightforward, involving short leads in the H.F. circuits and so leading to a high measure of stability.

A modern battery receiver thus follows the lines of Fig. 1. In order to obtain both simply and cheaply, a high degree of sensitivity and selectivity, iron-core tuning coils are employed, and the H.F. valve is preceded by a band-pass filter of the link-coupled type. The aerial is tapped well down its tuned circuit, and a change-over switch alters its connection for the long waveband, in order that the loading on the tuned circuit may remain constant on both wavebands.

The H.F. valve is of the short-base, variable- μ type, and consequently cannot handle a very large input without

introducing distortion. For local reception, therefore, it is necessary to reduce the aerial input, and this is done by the Local-Distance switch S_1 , which permits the 100 ohms resistance R_1 to be connected at will across the aerial and earth terminals.

The Receiver Circuits

The volume control proper, of course, takes the form of the potentiometer R_3 of 5,000 ohms connected across a $4\frac{1}{2}$ volts bias battery, and the bias is applied to the H.F. valve through the filter comprising the 0.1 mfd. condenser C_4 and the 5,000 ohms resistance R_2 . In order to avoid a continuous discharge of the bias battery, its connection is completed through the On-Off switch S_3 , the other pole of which breaks negative L.T.

The intervalve coupling is of the tuned grid type, and is fed from the H.F. valve with the aid of the choke Ch_1 and the 0.0002 mfd. condenser C_7 . The grid detector is connected across the whole of the tuned circuit in order to secure maximum sensitivity, and the values of the grid leak and condenser, R_6 and C_8 , are chosen to secure high-quality reproduction. An H.F. choke Ch_2 is included in the detector anode circuit in order to secure proper reaction effects and to prevent the leakage of H.F. currents into the purely L.F. circuits. Reaction is controlled in the usual way by a variable condenser C_9 , but it should be noted that this has the unusually large value of 0.0005 mfd., due to the small number of reaction turns provided on the intervalve coil.

The change-over switch S_2 in the detector grid circuit permits a gramophone pick-up to be connected, and on gramophone the negative grid bias is arranged to be 1.5 volts. The detector is an HL2-type valve, and it is coupled to the driver by means of a transformer having a ratio of 1-3.5, across the primary of which is joined the tone correction

filter R_8 and C_{10} . The driver is an L.2 valve coupled to the PD.220 output valve by a step-down transformer with a ratio of 2-1. No bias is applied to this valve, and in order to suppress parasitic oscillation two 0.005 mfd. condensers C_{13} and C_{14} are connected across the output transformer primary.

Since the slightest trace of battery coupling can lead to considerable distortion with Class "B" working, thorough de-coupling is included, the detector and driver stages being de-coupled by the 10,000 ohms resistances R_7 and R_9 with the 2 mfd. condensers C_{11} and C_{12} . The

Modern Battery Four—

anode circuit of the H.F. valve is also de-coupled by a 10,000 ohms resistance R₄ and a 2 mfd. condenser C₆, while the screen circuit is fed through the 10,000 ohms resistance R₅ with a 0.1 mfd. condenser C₅ shunted to earth. There is thus little possibility of the internal resistance of the H.T. battery causing trouble, and experiments indicated that the insertion of a 2,000 ohms resistance in series with the H.T. battery led only to a reduction in volume through the reduced voltage applied to the valves. Since a resistance of this order represents the maximum that is likely to occur in practice, no trouble from this source should be evident.

It will thus be seen that the receiver is quite straightforward without unnecessary frills, and yet includes everything necessary for good quality reproduction with a degree of sensitivity and selectivity sufficient for all but the most stringent requirements. It is economical in upkeep, for the total anode current with the volume control at maximum and no ap-

plied signal is but 9.6 mA. at 120 volts. When a signal is applied, of course, the current rises to a degree dependent upon the volume level adopted, but under normal conditions it is unlikely to exceed an average of some 15 mA.

The receiver is in no way critical, and if the specified layout be followed no difficulty whatever should be experienced either in construction or adjustment. The assembly is on a metal-covered chassis, which may be obtained with the large holes already drilled. Before mounting the gang condenser, the leads to the fixed plates should be attached, since the soldering tags are not readily accessible when this component is in position. It is very important to see that the gang condenser frame makes sound contact at each end with the metal base, and it is a wise plan to tighten its fixing bolts when the set has

Full-size blue print of this receiver is available from the Publishers at 1s. 6d. each, post free.

plied signal is but 9.6 mA. at 120 volts. When a signal is applied, of course, the current rises to a degree dependent upon

PRACTICAL WIRING DIAGRAM

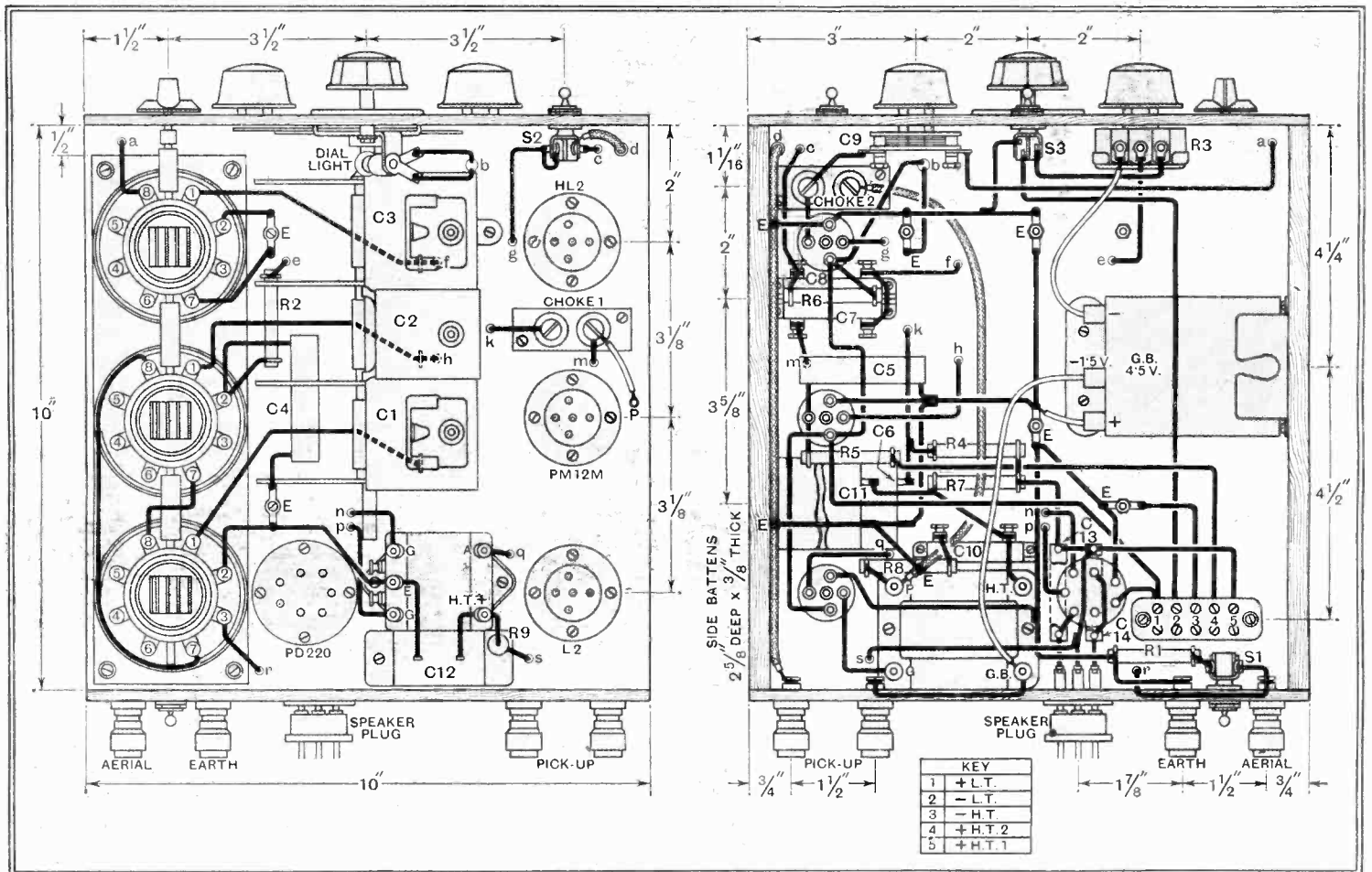

Wiring is carried out with tinned copper wire run in insulating sleeving, but it should be noted that the gramophone pick-up lead and the detector anode lead to the L.F. transformer are both screened.

- 1 Three-gang condenser, 0.0005 mfd. and dial
C1, C2, C3 Utility W.314/3
(British Radiophone, Polar.)
- 1 Assembly of three coils Varley "Nicore" BP36
- 3 Fixed condensers, 2 mfd. 750 V. D.C. test
C6, C11, C12 Peak Type A3
- 2 Fixed condensers, 0.1 mfd. tubular
C4, C5 Peak Type "M"
- 2 Fixed condensers, 0.005 mfd. tubular
C13, C14 Peak Type "M"
- 1 Fixed condenser, 0.01 mfd. C10 Graham-Farish
- 1 Fixed condenser, 0.0001 mfd. C8 Graham-Farish
- 1 Fixed condenser, 0.0002 mfd. C7 Graham-Farish
(Dubilier, Ferranti, Formo, Goltone, Hellesen, Igranic, Loewe, T.C.C., Telsen, Wego.)
- 1 Reaction condenser, 0.0005 mfd. with knob C9
Ormond No. 8 Semi-Circular type
(Magnum)
- 1 Resistance, 100 ohms 1 watt R1 Claude Lyons
- 1 Resistance, 5,000 ohms 1 watt R2 Claude Lyons
- 5 Resistances, 10,000 ohms 1 watt
R4, R5, R7, R8, R9 Claude Lyons
- 1 Resistance, 250,000 ohms 1 watt R6
(Dubilier, Erie, Seradex.) Claude Lyons
- 3 5-pin Valve Holders Clix Chassis mounting type
- 1 7-pin Valve Holder Clix Chassis mounting type
(Goltone, Peh, W.B.)

LIST OF PARTS

After the particular make of component used in the original model, suitable alternative products are given in some instances.

- 2 H.F. Chokes Ch1, Ch2 McMichael Binocular Junior
(Goltone, Kinva, Wearite.)
- 1 L.F. Transformer, 3:1 Ferranti AF8
(Igranic, R.I., Varley.)
- 1 Driver Transformer Varley D.P.41
(Benjamin, Bulgin, Ferranti, Igranic, Multitone, R.L. Telsen, Wearite, W.B.)
- 1 5-way Connector Wilburn
- 13-pin Plug complete with socket panel Belling-Lee No. 1119
- 4 Ebonite shrouded Terminals, aerial, earth, pick-up (2) Belling-Lee Type "B"
- 1 Wire-wound Volume Control, 2,000 ohms R3
Claude Lyons Type P.58
(Colverh, Haynes Radio, Walnut.)
- 1 5-way Cable, 30in, with plugs and spade ends Belling-Lee
(Goltone, Harbros, Lewcos.)

- 1 G.B. Battery, 4½ volts Siemens G.1
(Grosvenor.)
- 3 G.B. Plugs (Belling-Lee, Ealex.) Clix Type "B"
- 1 G.B. Battery Clip Bulgin No. 2
(Gripso.)
- 1 Toggle Switch, make and break S1 Bulgin S.60
- 1 Toggle Switch, three-point S3 Bulgin S.67
- 1 Toggle Switch, single pole change-over
S2 Bulgin S.81
(British Radiophone, Claude Lyons.)
- 1 Dial Lamp, 2 volts Bulgin Type H
- 1 length Screened Sleeving Harbros
(Goltone, Lewcos.)
- Wood Panel, 9in. x 10in. 3-ply Peto-Scott
- Plymax Baseboard, 10in. x 10in. x 3in.
(Or metal chassis, Magnum)
- 1oz. No. 22 Tinned Copper Wire, 6 lengths Systoflex,
Wood, Wire, etc.
- Screws:—8 3in. No. 6 R/hd.; 30 3in. No. 4 R/hd.;
2 3in. No. 4 C/sk.; 4 1/2in. No. 4 C/sk.; 6 3in.
No. 4BA R/hd.
- Loud Speaker W.B. "Microfode" PM4A
- Valves:—1 Mullard PM12M or Marconi or Osram VS24;
1 Mazda HL2 or Marconi or Osram HL2; 1 Mazda
PD220 or Marconi or Osram LP2; 1 Mazda
PD220 or Marconi or Osram B21.

ment, it should be reduced by slackening off the volume control rather than by employing less reaction. The switch *SI*, of course, must be set for distance while carrying out the ganging operations.

When tested on a good aerial in the heart of London, no difficulty was found in obtaining full loud-speaker volume in daylight from stations such as Brussels, North Regional, Langenberg, Fécamp, Huizen, Radio-Paris, and Berlin, while others were available at good strength. The selectivity was found sufficient to permit the reception of many distant stations situated in wavelength between the two locals, and, as might be expected with iron-core tuning coils, the blanketing effect of the latter was reduced to a minimum.

The Output Valve

The quality of reproduction with the specified speaker is of a very satisfying order, and the volume obtainable before overloading occurs is adequate for most requirements, the best results being secured by setting the switches mounted on the speaker to "B" and "H," giving a transformer ratio of 80-1. Where a different speaker is used, of course, care must be taken to see that it is correctly matched to the Class "B" valve. This requires a load impedance of some 17,000 ohms, and the output transformer must be of the Class "B" type with a low-resistance primary. With a different speaker, some modification to the values of R8 and C10 might prove advisable in order to secure the correct tone. It is hoped to deal with matters of this nature in a further article, however.

A specimen receiver built to this design will be on view on the "Wireless World" Stand at Olympia.

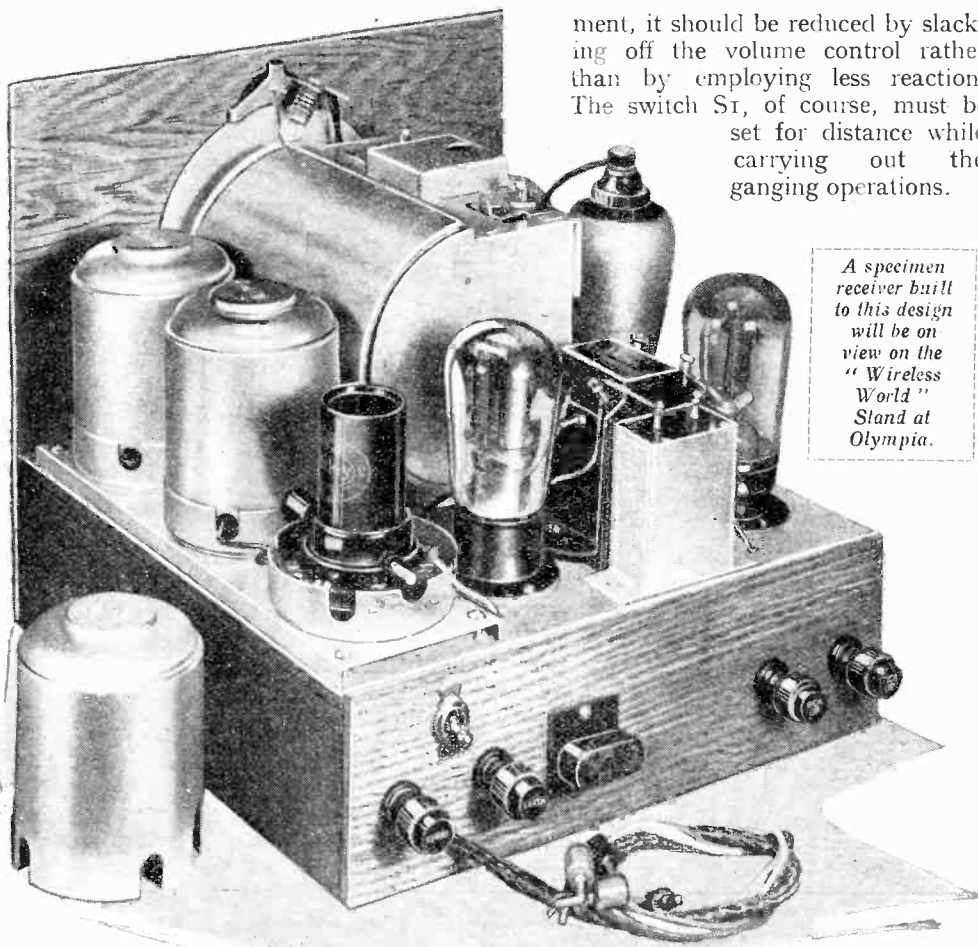

The local-distance switch is fitted at the rear above the aerial and earth terminals.

been built for a few weeks, since the wooden base sometimes shrinks slightly.

A screened anode lead to the H.F. valve is unnecessary, and would, in fact, give an undesirable increase in the stray capacity of the intervalve tuned circuit. As a matter of precaution against unwanted couplings, however, both the detector anode lead and the pick-up connection are screened.

Some 120 volts should be applied to H.T.1 with about 80 volts to H.T.2 and 1.5 volts bias on the driver valve. Greater volume and sensitivity will be obtained with 150 volts on H.T.1 and some 80 to 100 volts on H.T.2, but the current consumption will increase considerably. The higher voltages, therefore, are only recommended where economy is not of the first importance.

Ganging

Good quality reception of the local station should at once be obtained, provided that the matching to the speaker is correct and the only initial adjustment required is to the ganging. In general, it will be found that the trimmer on C3 should be nearly fully unscrewed, while that on C1 will need screwing nearly fully home. A station should be tuned in on as low a wavelength as possible, and each trimmer adjusted for maximum response, using as much reaction as possible without the set actually oscillating. If the volume be too great for accurate adjust-

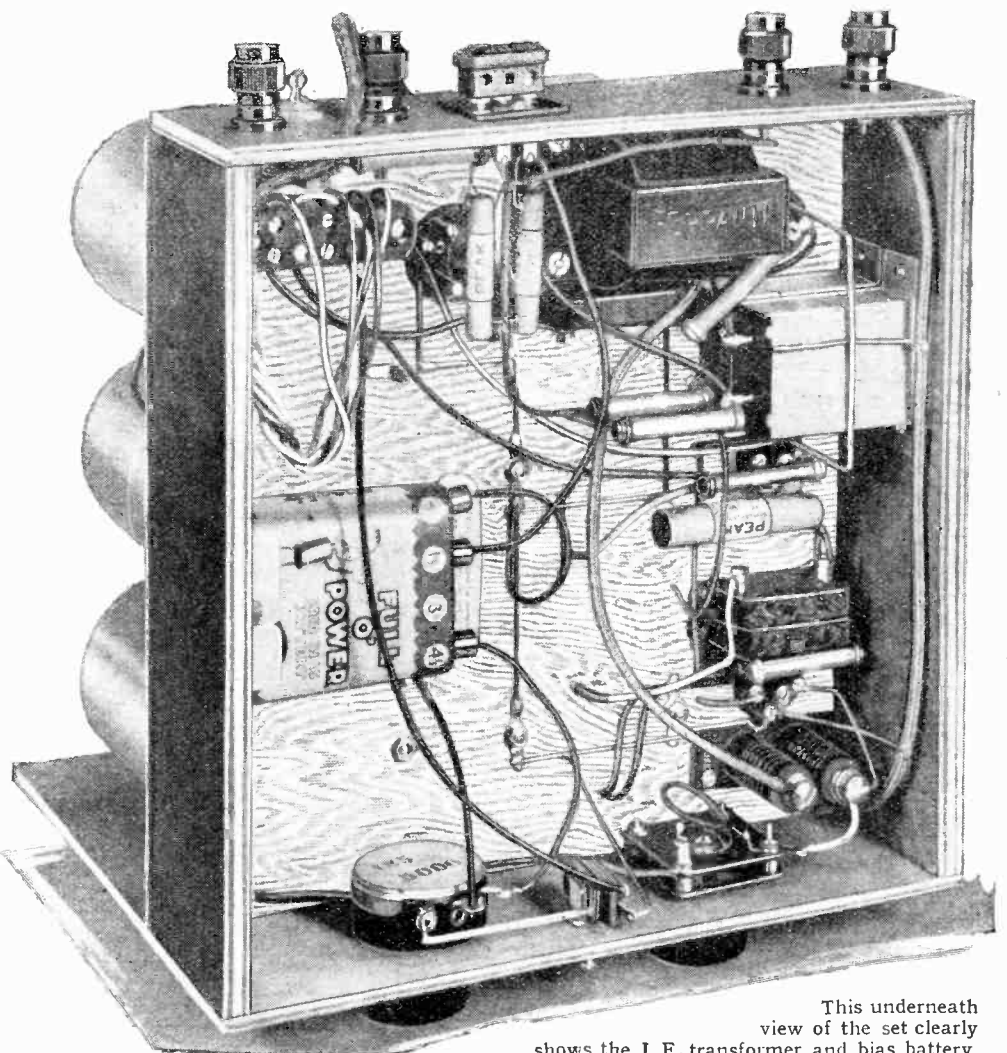

This underneath view of the set clearly shows the L.F. transformer and bias battery.

Modern Battery Four—

Considerable latitude in the choice of valves is permissible without alteration to the receiver. From many points of view the Class "B" valve is the most critical, and if a different type be employed the output transformer ratio will have to be altered. When using the Marconi-Osram B.21 Class "B" valve, for instance, the load required is 12,000 ohms, so that a 65-1 ratio would be suitable with the specified speaker. This valve also requires $4\frac{1}{2}$ volts negative grid bias; if it be used, therefore, the centre tap of the driver transformer must be disconnected from the chassis, and joined instead to the negative terminal of the bias battery. The driver appropriate to this valve is the L.P.2 of the same make.

For the detector any triode with an A.C. resistance between 10,000 ohms and 20,000 ohms may be used, and the valve should have as high an amplification factor as possible. Unless the H.F. valve is of the short-base type, however, the use of a different make will necessitate fitting a higher voltage bias battery in order to secure an adequate control of volume. The Marconi-Osram V6.24 is of the short-base type, and when using it no changes to the set or bias are needed.

Although the demands upon the H.T. battery are quite moderate it is advisable to choose one of medium capacity if a long working life is to be obtained. The question of the L.T. supply should also not be overlooked, and a 2-volt accumulator of fairly high capacity is advisable. The total filament current is about 0.7

THE NEW MONODIAL SUPER

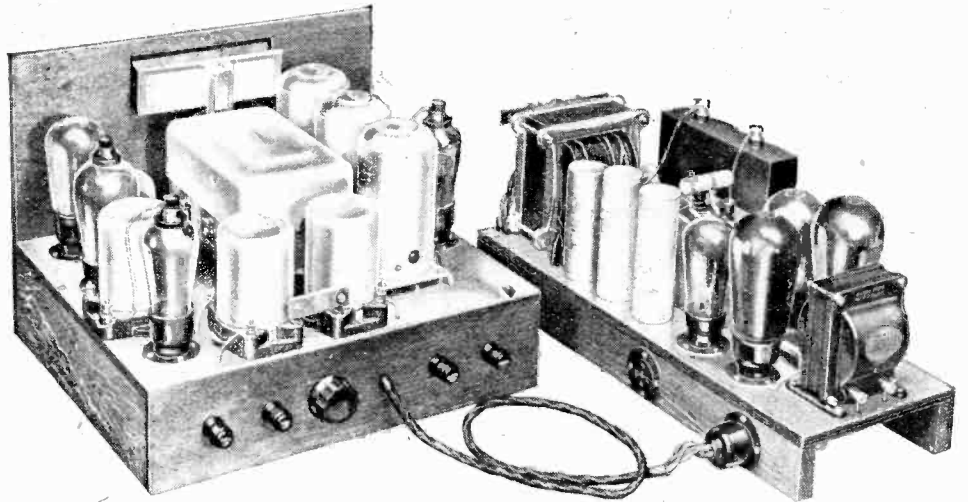

An A.C. Receiver Embodying Every Practical New Development in Superheterodyne Technique

Among the features of the new receiver are a Pentagrid single-valve frequency-changer, which reduces the possibility of whistle production, a duo-diode-pentode second detector giving delayed A.V.C. for eliminating fading, and a 6-watt push-pull output stage.

Full constructional details, together with complete wiring diagrams, were included in the July 21st and 28th issues of *The Wireless World*, copies of which are available from the publishers. Full size Blue Print is also available, price 1/6 post free.

DUAL-PURPOSE EXTENSION LEADS

Solving the Problem of Aerial Connections

WHILE the following notes may not hold good with all types of receivers, especially 2-H.F. sets, the method has worked very satisfactorily with an all-mains superheterodyne and also with a simple Det.-2LF. circuit.

The problem was not new; the receiver was wanted for use in an upstairs front room, the aerial lead-in being in a downstairs back room. The house being already wired in several rooms for extra L.S.'s, it

was decided to use this wiring for conveying the H.F. signals to the receiver.

It was important, of course, to prevent H.F. impulses getting into the L.F. part of the receiver; an H.F. choke in each lead followed by a small condenser to earth looked after this point, the value of the condenser being, within limits, immaterial. The larger it is the more efficient the filter becomes, but it must be remembered that it is in parallel with both the main and

additional speakers—that is, if the extra speakers are in parallel, as is usual. [With a normal choke output feed, one of the two condensers forming the filter is in parallel, while both of them are in series, across the speakers.] The value should be about 0.0005-0.001 mfd. Unless very special care has been taken in the balancing of the speakers (when working together) it is unlikely that this additional capacity to that already provided by the leads will make much difference. The H.F. chokes should naturally be of an efficient type.

A large condenser—say of 2 mfd.—should be included in each lead, so that an accidental short to earth in one of the speaker leads will not cause damage to the output valve by short-circuiting its bias resistance (the circuit diagram makes this point clear).

The lead-in proper can be connected to any convenient point of the extension wiring, while the lead to the set should be taken from the "live" side of one of the H.F. chokes—which one is best found by experiment, as there may be a difference between them. The inclusion of a small fixed condenser in the aerial lead is also worth trying. Admittedly, there must be very considerable losses of H.F. energy, but this is inevitable with any scheme when it comes to carrying the lead-in through the house unless elaborate measures are taken regarding spacing of the lead from earthed objects, and this laudable ideal is seldom favoured with the approval of the household! In point of fact, it was found that the extension leads alone provided ample "pick-up."

Individual cases will no doubt require some modification of the above details, but the data given will be sufficient basis for experiment.

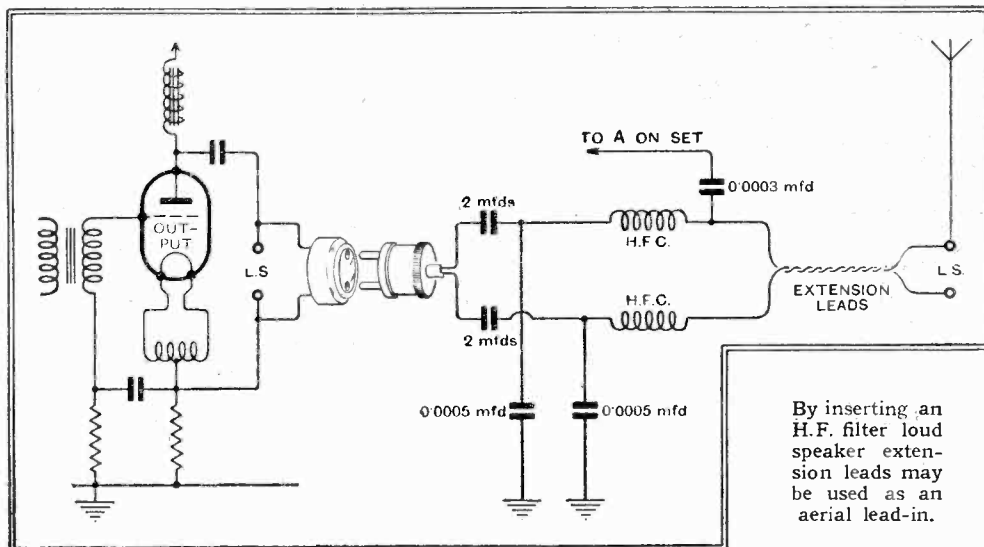

By inserting an H.F. filter loud speaker extension leads may be used as an aerial lead-in.

UNBIASED

By **FREE GRID**



Worthy inhabitants of Woolloomoolloo.

Marooned in the Channel

IT is, I think, a great scandal that, in spite of the blowing of trumpets by the P.M.G. and his staff concerning their mighty achievements in the realm of telephony, the traveller is still unable to ring up anybody in England from a cross-Channel boat. This, mark you, when it is possible, as the P.M.G. tells us, to converse over thousands of miles with the worthy inhabitants of Woolloomoolloo (though it is not stated why anybody in their right senses would want to get in touch with that benighted spot).

In the case of cross-Channel boats, however, the P.M.G. still leaves us marooned and expects us to conduct our business by utilising the old-fashioned wireless telegraph service. Only last week I suddenly recollected, when in mid-Channel, a most urgent telephone call which I should have made before I left London. Quite naturally, I sought out the telephone box, which ought to have been on board but wasn't, and, as the matter was quite beyond the scope of a telegram, I had to wait until I got to the other side of the Channel before I could make my call.

Surely it would not be a costly matter to build a low-powered telephony station at Dover which would connect up with the ordinary Post Office telephone system. I noticed the other day that the ever-enterprising Dutch have equipped the ferry boats across the Scheldt estuary with low-powered wireless telephony so that members of the business community can keep in constant touch with their offices.

"Scophony"

WHATEVER criticism can be legitimately levelled against the use of the word "scophony" to describe the latest system of television, I can heartily congratulate the people responsible for it, inasmuch that they have had the good sense to follow the advice I gave some time ago and have avoided a Latin and Greek hybrid.

This is the utmost I can say in favour of the word, however, for I notice that it is being used to describe "vision" apparatus pure and simple and not a combined vision and sound arrangement such as I had in mind when I first suggested the use of such a term.

Crystal Gazing

I WONDER if any kind-hearted reader can tell me where I can get hold of a crystal set, or, failing that, a crystal cup and catswhisker fitting, or even just a plain crystal? I spent two weary days tramping the streets of London in the heat wave trying to get hold of such an article on behalf of a Scottish aunt of mine who has recently followed the example of many of her fellow countrymen and moved south to a dwelling in the shadow of the aerials at Brookmans Park.

I started off by visiting the lordly emporiums of the West End, and, after a vain and perspiring search, I gradually descended in the social scale until I found myself in the Caledonian market.

Strange to relate, although I was offered two coherers and an old Marconi magnetic detector, I unearthed only one crystal receiver, and this of very ancient vintage. The grasping owner, taking advantage of their scarcity, had the nerve to ask me five guineas for his wretched contraption. Needless to say, I speedily told him where he got off, and departed in high dudgeon.

In view of the fact that there will be a large demand for this type of receiver even in the London area when Droitwich opens next year, I cannot but view the dearth of them with some misgivings. When the



In the Caledonian Market.

demand does come we shall, I suppose, be held up to ransom to the tune of five guineas apiece, as we were in 1922.

"Wired Wireless" on Buses

I HAVE seen it stated again and again by responsible people who ought to know better that it is quite impossible to quell the interference due to trams and

trolley buses. In fact, I have heard this so often that I have almost begun to believe it. I was all the more astonished, therefore, when I happened to be taking a ride in one of these juggernauts the other day in the Fatherland to find that the problem had so far been overcome that a receiver had been installed on the vehicle itself.

The programme was quite free from electrical interference, though I must admit that it was not wireless, but wired wireless, which was being used. This, however, only makes the achievement more astonishing still, as with this latter arrangement the elimination of interference is a still more difficult problem,



"Impossible."

the music being guided on its path by the same conductors whence comes the interference.

It is not the same as ordinary wireless, where some measure of screening could have been adopted. Nevertheless, elaborate filter circuits made up of a bewildering array of chokes and condensers had done the trick all right. I trust, therefore, that the "impossible" brigade which exist in this country will put this in their pipe and smoke it. If I remember rightly they shouted "impossible" when broadcasting was first mooted over a decade ago.

A Job for a Censor

IT was nearly a year ago that I felt constrained to chastise certain representatives of the lay press who tried to tell us that they had witnessed the demonstration of a model train which derived all its power from the human body; the aforementioned power, so they said, increased with mental concentration and decreased with poor health. I defined this statement as "tripe," and issued a challenge which was not accepted; on the contrary, I was subjected to much vulgar abuse.

And now, after all these weary months, the mystery has been solved by the publication of the magic circuit by the inventor himself, and my honour has been vindicated. I do not suppose for one moment, however, that the newspapers concerned will see fit to render me the apology that is due; on the contrary, I expect that they will merely bend their energies to the evolution of some more scientific sob stuff.

Exhibitors at OLYMPIA

*I*N the following list we give the names and addresses with Stand numbers, and a reference (in heavy type) to be used in conjunction with the plan on the accompanying page for locating individual Stands.

Arranged in Alphabetical Order

Name and Address.	Stand.	Ref.	Name and Address.	Stand.	Ref.	Name and Address.	Stand.	Ref.
ACTON Battery Co., Ltd. Dorland House, Regent St., W.1.	230	E 1	Bush Radio, Ltd. Woodger Rd., Shepherd's Bush, W.12.	64	C 3	Electrical Measuring Instrument Co., Ltd. 55, Cardington St., N.W.1.	222	H 1
Adey Portable Radio 99, Mortimer Street, W.1.	229	E 2	CADISCH & Sons, R. 5-6, Red Lion Sq., W.C.1.	T5	H 4	Electro-Dynamic Construction Co., Ltd. Devonshire Grove, S.E.15.	240	E 2
Aerialite, Ltd. 10, Amber Street, Manchester.	220	H 2	Carrington Mfg. Co., Ltd. 24, Hatton Garden, E.C.1.	83	B 5	Ensign, Ltd. 88, High Holborn, W.C.1.	T24	E 4
Amalgamated Press, Ltd. Fleetway House, Farringdon St., E.C.4.	11	D 2	Celestion, Ltd. London Rd., Kingston-on-Thames.	125	A 4	Epoch Radio Mfg. Co., Ltd. Exmouth House, Exmouth St., E.C.1.	2	C 5
Amplion (1932), Ltd. 82-84, Rosoman St., E.C.1.	104	A 4	Chloride Electrical Storage Co., Ltd. Clifton Junction, Nr. Manchester.	241	E 3	Ever Ready Co. (G. B.), Ltd. Hercules Place, Holloway, N.7.	57	C 1
Apollo Gramophone Co., Ltd. 4, Bunhill Row, E.C.1.	T23	E 3	Chorlmet Radio Electric, Ltd. Stal House, Judd St., W.C.1.	215	H 3	FAUDELS , Ltd. 36-40, Newgate St., E.C.1.	T3	H 3
Automatic Coil Winder & Electrical Equip. Co., Ltd. Winder House, Douglas St., S.W.1.	47	C 1	Churchmans, Ltd. Colchester.	T1	H 3	Ferranti, Ltd. Hollinwood, Lancashire.	74	C 2
BAIRD Television, Ltd. 133, Long Acre, W.C.2.	117	A 2	City Accumulator Co., Ltd. 18-20, Norman's Buildings, Central St., E.C.1.	94	B 1	Film Industries, Ltd. 60, Paddington St., W.1.	246	E 2
Bakers Selhurst Radio 75-77, Sussex Rd., Croydon, Surrey.	35	D 3	Clarke & Co. (M.c.), Ltd., H. George St., Patricroft, Manchester.	91	B 2	Flinders (Wholesale), Ltd. East Stockwell St., Colchester.	T7	H 5
Balcombe, Ltd., A. J. 52, Tabernacle St., E.C.2.	61	C 2	Climax Radio Electric, Ltd. Haverstock Works, Parkhill Rd., N.W.3.	84	B 5	Fox Publications, Ltd. 14, Britannia St., King's Cross, W.C.1.	214	H 3
Belling & Lee, Ltd. Cambridge Arterial Rd., Enfield, Middx.	45	D 1	Cole, Ltd., E. K. Ekco Works, Southend-on-Sea, Essex.	70	C 4	Fuller Accumulator Co. (1926), Ltd. Woodland Works, Chadwell Heath, Essex.	34	D 3
Benjamin Electric, Ltd. Brantwood Works, Tariff Rd., N.17.	42	D 1	Columbia Graphophone Co., Ltd. 98, Clerkenwell Rd., E.C.1.	66	C 4	GARRARD Engineering & Mfg. Co., Ltd. 17, Grafton St., W.1.	119	A 1
Benn Bros., Ltd. Bouverie House, Fleet St., E.C.4.	212	H 3	Colvern, Ltd. Mawneys Rd., Romford, Essex.	56	C 1	General Electric Co., Ltd. Magnet House, Kingsway, W.C.2.	90	B 3
Bernard Jones Publications, Ltd. 58, Fetter Lane, E.C.4.	10	D 3	Consolidated Radio Co., Ltd. Warple Way, Acton, W.3.	24	D 3	General Electric Co., Ltd. (Osram) Magnet House, Kingsway, W.C.2.	92	B 2
Birmingham Sound Reproducers, Ltd. Claremont St., Old Hill, Staffs.	218	H 2	Cosmocond, Ltd. Cambridge Arterial Rd., Enfield, Middlesex.	14	D 1	General Electric Co., Ltd. (Batteries) Magnet House, Kingsway, W.C.2.	112	A 3
Block Batteries, Ltd. Abbey Rd., Barking, Essex.	22	D 2	Cossor, Ltd., A. C. Cossor House, Highbury Grove, N.5.	89	B 3	General Mouldings Co., Ltd. Nelson St. Works, Mornington Crescent, N.W.1.	59	C 1
Botolph Radio, Ltd. 119, Bishopsgate, E.C.2.	244	E 2	Cromwell (Southampton), Ltd. 32-33, Brinton's Terrace, South- ampton.	76	B 2	Gilbert & Co., Ltd., C. Arundel St., Sheffield.	T20	E 4
Bowyer-Lowe & A.E.D., Ltd. Diamond Works, Coombe Rd., Brighton.	102	A 3	DALLAS & Co., Ltd., John E. 6-10, Betterton St., W.C.2.	T22	E 3	Goodmans 69, John St., E.C.1.	109	A 3
Bridger & Co., R. O. 4, Shelford Place, Church St., N.16.	221	H 2	Darwins, Ltd. Fitzwilliam Works, Sheffield.	43	D 1	Grafton Radio, Ltd. 79, Lot's Rd., Chelsea, S.W.10.	111	A 3
Britannia Batteries, Ltd. 233, Shaftesbury Ave., W.C.2.	124	A 3	De La Rue & Co., Ltd., Thos. 90, Shernhall St., Walthamstow, E.17.	6	D 5	Graham Farish, Ltd. 153, Masons Hill, Bromley, Kent.	205	H 1
British Blue Spot Co., Ltd. 94-96, Rosoman St., E.C.1.	97	A 1	Department of Overseas Trade 35, Old Queen St., S.W.1.	19	D 1	Gramophone Co., Ltd. 98, Clerkenwell Rd., E.C.1.	80	B 4
British Broadcasting Corporation Broadcasting House, W.1.	150	B 1	Dew & Co., Ltd., A. J. 33, Rathbone Place, W.1.	T13	E 5	Grampian Reproducers, Ltd. Station Ave., Kew Gardens, Surrey.	23	D 3
British Ebonite Co., Ltd. Nightingale Rd., Hanwell, W.7.	207	H 2	Diggle & Co., Alfred Jane St., Rochdale, Lancs.	13	D 1	Gripco Co. 28, Victoria St., S.W.1.	251	E 1
British General Mfg. Co., Ltd. Brookley Works, Brockley, S.E.4.	38	D 3	Dubilier Condenser Co. (1925), Ltd. Ducon Works, Victoria Rd., North Acton, W.3.	68	C 5	Grosvenor Electric Batteries, Ltd. 2-3, White St., Moorgate, E.C.2.	126	A 4
British Pix Co., Ltd. 118, Southwark St., S.E.1.	204	H 1	Dulcetto-Polyphon, Ltd. 2-3, Newman St., W.1.	T25	E 4	HACKER & Sons, H. Perfecta Works, Ray Lea Rd., Maidenhead.	120	A 1
British Radiophone, Ltd. Aldwych House, Aldwych, W.C.2.	118	A 1	Dyson & Co., Ltd., J. 5, Godwin St., Bradford.	T17	E 4	Halford Radio, Ltd. 39, Sackville St., W.1.	49	B 1
British Rola Co., Ltd. Minerva Rd., Park Royal, N.W.10.	52	B 1	EARL Mfg. Co., Ltd. Avenue Works, Hanover Park, S.E.15.	249	E 2	Harlie, Ltd. Balham Rd., Lower Edmonton, N.9.	54	B 1
British Thomson-Houston Co., Ltd. Crown House, Aldwych, W.C.2.	209	H 2	Eastick & Sons, J. J. 118, Bunhill Row, E.C.1.	T12	F 5	Haynes Radio 57, Hatton Garden, E.C.1.	9	D 3
British Wireless for the Blind 224, Great Portland St., W.1.	15	D 1	East London Rubber Co. 29-33, Great Eastern St., E.C.2.	T19	E 4	Hayberd & Co., F. C. 10, Finsbury St., E.C.2.	16	D 1
"Broadcaster" Long Acre, W.C.2.	T18	E 4	Econasign Co., Ltd. 92, Victoria St., S.W.1.	231	E 1	Hellesens, Ltd. Morden Rd., S. Wimbledon, S.W.19.	106	A 5
Brown Bros., Ltd. Great Eastern St., E.C.2.	T15	E 4	Edge Radio, Ltd. Bolton, Lancs.	121	A 2	Henderson Wireless & Electrical Service 54, Queen's Rd., Brighton.	T16	E 4
Brunswick, Ltd. 1-3, Brixton Rd., S.W.9.	67	C 5	Edison Swan Electric Co., Ltd. 155, Charing Cross Rd., W.C.2.	82	B 5	Henley's Telegraph Works Co., Ltd., 11, Holborn Viaduct, E.C.1.	53	B 1
Bulgin & Co., Ltd., A. F. Abbey Rd., Barking, Essex.	122	A 2	Eldeco Radio, Ltd. 62, Conduit St., W.1.	100	A 3	Higgs (Gt. Britain), Ltd. Westbourne Place, Hove, Sussex.	12	D 2
Bullphone Radio New North Rd., Barkingside, Essex.	115	A 2				High Vacuum Valve Co., Ltd. 113, Farringdon Rd., E.C.1.	108	A 3
Burgoyne Wireless (1930), Ltd. 34a, York Rd., King's Cross, N.1.	3	D 5						
Burton, C. F. & H. Progress Works, Bernard St., Walsall.	4	D 5						

The Wireless World STAND FINDER

GUIDE TO ALL EXHIBITORS AT OLYMPIA

Any Stand in the Exhibition can instantly be located by using this squared plan in conjunction with the references shown in black type in the accompanying list of exhibitors.

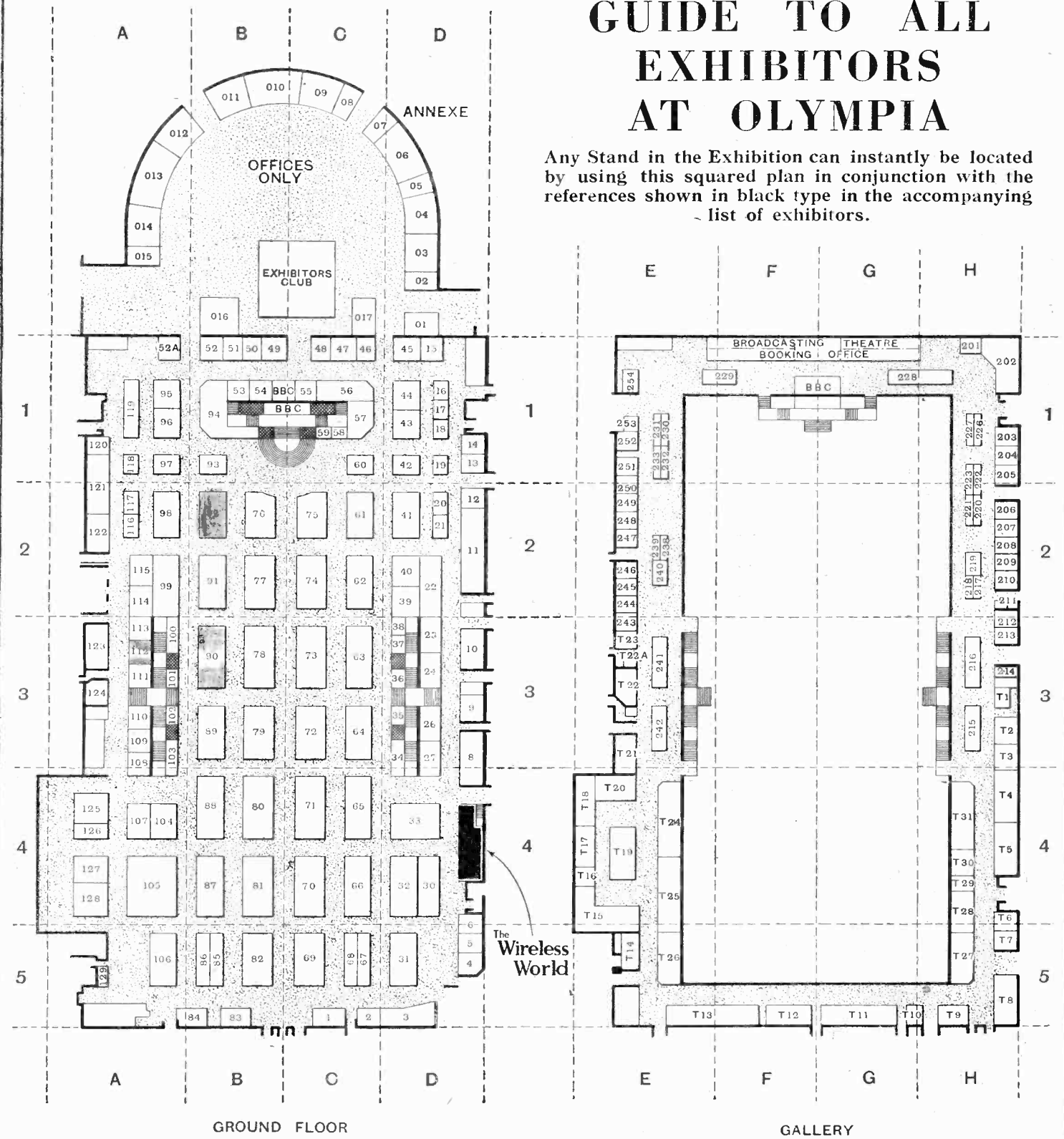

A selection of Constructional Receivers recently described in the pages of this journal will be on view at *The Wireless World* Stand (No. 7).

Exhibitors at Olympia--

Name and Address.	Stand.	Ref. Sq.	Name and Address.	Stand.	Ref. Sq.
Hillman Brothers 123, Albion St., Leeds.	T28	H 4	Shalless & Evans. Tranquil House, Tranquil Vale, Blackheath, S.E.3.	254	E 1
Hobday Bros., Ltd. 21-27, Great Eastern St., E.C.2.	T11	G 5	Shawndel Tool Co. 99, Regent St., W.1.	203	H 1
Hustler, Simpson & Webb, Ltd. 317, Hoe St., Walthamstow, E.17.	62	C 2	Siemens Electric Lamps & Supplies, Ltd. 39, Upper Thames St., E.C.4.	31	D 5
IGRANIC Electric Co., Ltd. 147, Queen Victoria St., E.C.4.	86	B 5	Simpson's Electricals, Ltd. Grange Rd., Leyton, E.10.	17	D 1
Iliffe & Sons, Ltd. Dorset House, Stamford St., S.E.1.	7	D 4	Sinclair Speakers 49-50, Twyford St., N.1.	232	E 1
Itonia, Ltd. 58, City Rd., E.C.1.	T27	H 5	Six-Sixty Radio Co., Ltd. 17-18, Rathbone Place, W.1.	95	A 1
JACKSON Bros. (London), Ltd. 72, St. Thomas St., S.E.1.	116	A 2	Slektun Products Winder House, Douglas St., S.W.1.	46	C 1
Johnson Talking Machine Co., Ltd. 96, Clerkenwell Rd., E.C.1.	T9	H 5	Smith & Sons (Motor Accessories), Ltd., S. Cricklewood Works, N.W.2.	51	B 1
KENSINGTON , Ltd. 196, Upton Lane, Forest Gate, E.7.	245	E 2	Sonochorde Reproducers, Ltd. 1, Willesden Lane, N.W.6.	113	A 3
Kolster-Brands, Ltd. Cray Works, Sidecup, Kent.	63	G 3	Sound Sales, Ltd. Tremlett Grove, Junction Rd., N.19.	213	H 3
L.E.S. Distributors, Ltd. 15-16, Alfred Place, W.C.1.	T14	E 5	Sovereign Products, Ltd. 52, Rosebery Ave., E.C.1.	101	A 3
Lampex Radio & Electric Co. 62, Brewery Rd., Islington, N.7.	18	D 1	Standard Telephones & Cables, Ltd. Connaught House, Aldwych, W.C.2.	96	A 1
Lamplugh Radio, Ltd. 177, Foleshill Rd., Coventry.	219	H 2	Stratton & Co., Ltd. Balmoral Works, Bromsgrove St., Birmingham.	21	D 2
Lancashire Dynamo & Crypto, Ltd. 94, Petty France, Westminster, S.W.1.	50	B 1	Sunbeam Electric, Ltd. Sunbeam Rd., North Acton, N.W.10.	65	C 4
Lectro Linx, Ltd. 79a, Rochester Row, S.W.1.	37	D 3	Sunbeam Electrical Co., Ltd. 118-120, Charing Cross Rd., W.C.2.	TS	H 5
Lissen, Ltd. Worple Rd., Isleworth, Middx.	72	C 3	Swift Levick & Sons, Ltd. Clarence Steel Works, Sheffield.	36	D 3
London & Provincial Factors, Ltd. 146, Theobald's Rd., W.C.1.	T4	H 4	TANNOY Products 1-7, Dalton St., W. Norwood, S.E.27.	103	A 3
Lugton & Co., Ltd. 203, Old St., E.C.1.	T26	E 5	Telegraph Condenser Co., Ltd. Wales Farm Rd., N. Acton, W.3.	98	A 2
McMICHAEL Radio, Ltd. Wexham Rd., Slough, Bucks.	69	C 5	Telegraph Construction & Maintenance Co., Ltd. Enderley's Wharf, Greenwich, S.E.10.	248	E 2
Magnacore, Ltd. 85, Alsen Rd., Holloway, N.7.	223	H 1	Telephone Mfg. Co., Ltd. Hollingsworth Works, W. Dulwich, S.E.21.	217	H 2
Mains Power Radio, Ltd. Broadway Works, Eastern Rd., Romford, Essex.	211	H 2	Telsen Electric Co., Ltd. Aston, Birmingham.	88	B 4
Manufacturers Accessories Co. (1928), Ltd. 85, Great Eastern St., E.C.2.	T10	G 5	The 362 Radio Valve Co., Ltd. 415, Mare St., Hackney, E.8.	226	H 1
Marconiphone Co., Ltd. 210, Tottenham Court Rd., W.1.	77	B 2	Thompson, Diamond & Butcher 34, Farringdon Rd., E.C.1.	T21	E 3
Metal Agencies Co., Ltd. Queen Sq., Bristol.	T30	H 4	ULTRA Electric, Ltd. Erskine Rd., N.W.3.	78	B 3
Milnes Radio Co. Victoria Works, Church St., Bing- ley, Yorks.	242	E 3	Univolt Electric, Ltd. 119, Finsbury Pavement, E.C.2.	5	D 5
Montague Radio Inventions & Develop- ment Co., Ltd. Beethoven Works, Great College St., Camden Town, N.W.1.	87	B 4	VANDERVELL , Ltd., C. A. 319, Regent St., W.1.	228	G 1
Mullard Wireless Service Co., Ltd. Mullard House, Charing Cross Rd., W.C.2.	71	C 4	Varley (Oliver Pell Control, Ltd.) 103, Kingsway, W.C.2.	85	B 5
Multitone Electric Co., Ltd. 95, White Lion St., Islington, N.1.	55	G 1	Vince's Dry Batteries, Ltd. Lion Works, Garford St., E.14.	105	A 4
NATIONAL Radio Service Co. 15-16, Alfred Place, W.C.1.	T22A	E 3	Vulco Dry Batteries Co., Ltd. Vulco Works, N. 19.	110	A 3
New London Electronic Works, Ltd. East Ham, E.6.	107	A 4	WESTINGHOUSE Brake & Saxby Sig- nal Co., Ltd. 82, York Rd., King's Cross, N.1.	32	D 4
Newnes, Ltd., George 8-11, Southampton St., W.C.2.	8	D 3	Whiteley Electrical Radio Co., Ltd., Victoria St., Mansfield, Notts.	128 & 129	A4, A5
Nuvolon Electric, Ltd. Meredith Yard, Park Crescent, Clapham Park Rd., S.W.4.	238	E 2	Wilkins & Wright, Ltd. Holyhead Rd., Birmingham.	20	D 2
OLDHAM & Son, Ltd. Denton, Manchester.	123	A 3	Wingrove & Rogers, Ltd. Mill Lane, Old Swan, Liverpool.	93	B 1
Ormond Engineering Co., Ltd. Ormond House, Rosebery Ave., E.C.1.	99	A 2	Wireless & Gramophone Trader Dorset House, Stamford St., S.E.1.	T31	H 4
Orr Radio, Ltd. 63, Lincoln's Inn Fields, W.C.2.	40	D 2	Wireless League 12, Grosvenor Crescent, S.W.1.	233	E 1
Osborn, Chas., A. Regent Works, Arlington St., N.1.	202	H 1	Wireless Retailers Association of Gt. Britain 1, Mitre Court, Fleet St., E.C.4.	250	E 2
			Wright & Weaire, Ltd. 740, High Rd., Tottenham, N.17.	1	C 5
			ZEITLIN & Sons, Ltd., V. 54, Lamb's Conduit St., W.C.1.	T29	H 4

BLUE PRINTS

For the convenience of constructors full-sized blue prints are available of the following popular *Wireless World* sets that have been recently described, price 1s. 6d., post free.

Modern Straight Five. (June 22nd and 29th, 1932.)

Short Wave Two. (November 4th and December 23rd, 1932.)

Monodial D.C. Super. (December 2nd and 9th, 1932.)

Straight Three. (December 16th, 1932.)

Modern D.C. Threes. (December 30th, 1932, and January 6th, 1933.)

All-wave Monodial Super. (January 27th and February 10th, 1933.)

Modern A.C. Quality Amplifier (February 17th, 1933.)

Ferrocarril III. (February 24th and March 3rd, 1933.)

The Class "B" Ferrocarril Receiver. (April 17th, 1933.)

Universal A.C. Short-wave Converter. (April 28th, 1933.)

New Monodial Super. (July 21st and 28th, 1933.)

Modern Battery Four. (August 11th, 1933.)

These can be obtained from the Publishers, Iliffe & Sons Ltd., Dorset House, Stamford Street, London, S.E.1.

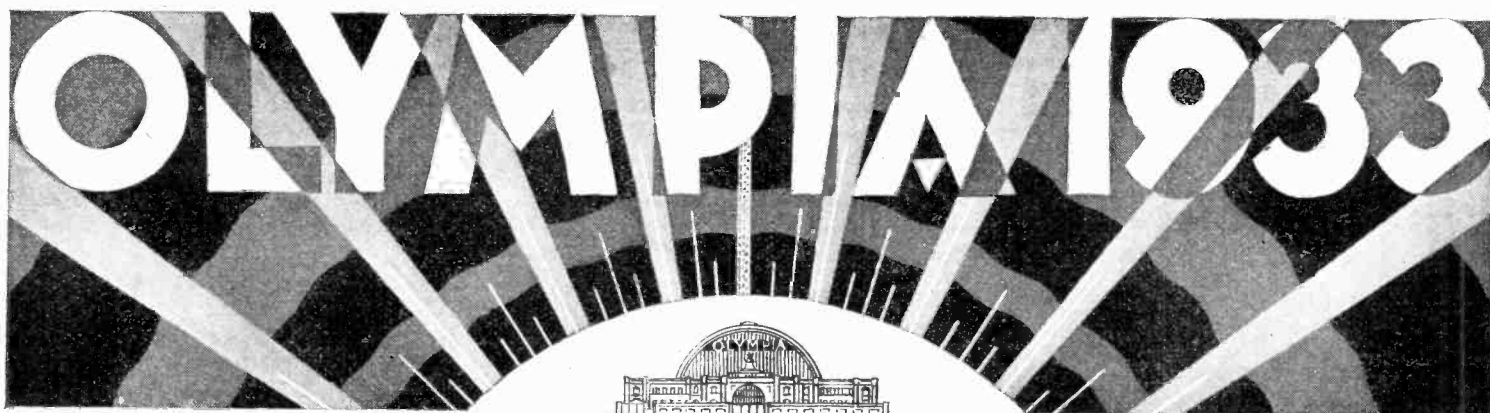

WHAT TO SEE AT THE SHOW

AS this issue of *The Wireless World* will be in the hands of our readers two or three days before the Exhibition at Olympia opens, it allows time for a study of the following pages before the actual visit to the Show is made, and we believe that readers will welcome this general guide to what is likely to be of outstanding interest on the stands.

We do not claim that the features picked out in the following pages as of special interest include all that is outstanding at the Show, for the reason that, having prepared this issue before Olympia opens, it has been necessary to depend very largely on material supplied by manufacturers or obtained from brief inspections of the apparatus.

New valves and components and new ideas in circuit design have presented the manufacturers with much wider scope for the exercise of individual ingenuity than for many years past. The superheterodyne receiver appears to have come in for the greatest amount of attention from the majority of set manu-

facturers; this is not surprising because the superheterodyne undoubtedly offers more scope than a straight set for making full use of the more interesting types of new valves and such circuit improvements as automatic volume control. Not that straight sets can be regarded as in any way obsolete, however, and there are some fine examples at the Show.

Amongst components it will be noticed that there have been a good many new products developed; in particular should be noted new coils of the iron core type, whilst complete tuning units are gaining in popularity. Various components and aerial equipment for reducing electrical interference are to be featured.

If our readers will study the pages which follow we think that they will gain a fairly comprehensive idea of what Olympia holds in store, and even for those who are unable to visit the Show, this issue, combined with our two further special Show numbers, will, we think, cover the ground and also provide a permanent record for reference.

Classified Forecast of Outstanding Items

TWO years ago the superheterodynes exhibited at Olympia could almost be counted upon the fingers of one hand; last year they were about equal in number to the multi-valve straight sets; this year they have not only completely routed the larger class of straight set but they have also made deep inroads on the territory of the four-valve receiver. This rapid and decisive advance of the superheterodyne has largely been occasioned by the imperative need for high selectivity under modern broadcasting conditions, for in no other way is it so easy to obtain the requisite degree of freedom from interference.

Although the superheterodyne will represent such a large proportion of the sets on show, this does not mean that there will be any lack of variety. On the contrary, no receiver offers so much scope for originality in design as the superheterodyne, with the result that there will be a greater selection of receivers than ever before.

As an illustration of the different receiver types which are now covered by the term superheterodyne, it is instructive to compare the extremes. One of the largest sets on view will be the R.G.D. model 1201A, in which no fewer than twelve valves are employed; variable-mu valves are used in the H.F. and I.F. circuits with a duo-diode-

SUPERHETERODYNES

triode acting in conjunction with a separate triode to give quiet delayed automatic volume control. The apparatus is specially designed for quality reproduction, and the L.F. circuits employ resistance-capacity coupled push-pull connected valves on the lines of the paraphase system. The output

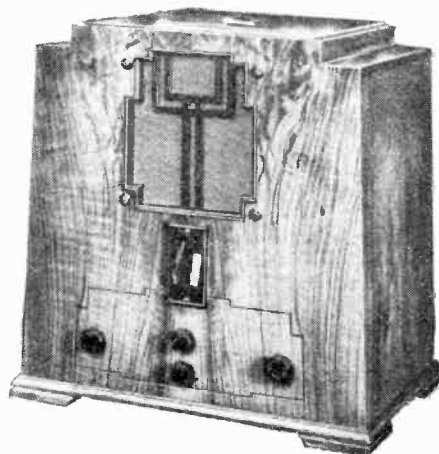

Marconiphone Model 276.

to the dual speakers is 6 watts, and a visual tuning indicator is fitted.

As a contrast to this extreme type, one might take the Varley model AP46, in which there are only four valves. The most interesting feature of this receiver is the omission of any I.F. amplifying stage, for the output of the H.F. pentode detector-oscillator frequency changer is coupled through a band-pass filter directly to the regenerative second detector. The frequency changer is preceded by a variable-mu H.F. stage with two tuned circuits, and the second detector is coupled to the pentode output valve by a tone correction circuit.

Between these two extremes lies every conceivable variety of superheterodyne, and most makers will be showing a number of different types. Thus, R.G.D. will have smaller receivers and Varley larger than the particular models just mentioned. R.G.D. will also be showing their model 701A, which has seven valves, and is rated for an output of 2 watts; there is a preliminary H.F. stage, a separate oscillator for frequency-changing purposes, and an anode bend second detector, while models are available for both A.C. and D.C. mains supplies. Their model 702A is a similar type of receiver, but is rated for a 2½ watts output, and it is fitted with a duo-diode-

What to See at the Show.—

triode second detector, to give delayed A.V.C., and there is a visual tuning indicator. The larger Varley superheterodynes are fitted with an intermediate frequency amplifying stage, and also incorporate an automatic volume control system.

The Ferranti receivers are notable not only for their electrical design but also for the break from tradition in the matter of their cabinet work, and for this alone they will be well worth inspection. The Gloria

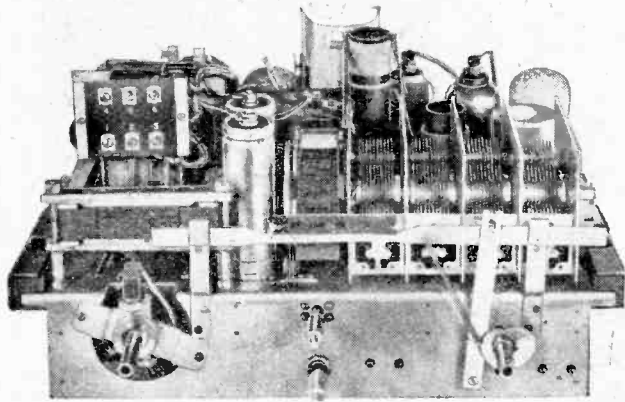

H.M.V. Superhet Concert 7 chassis.

model is obtainable in a variety of cabinet forms at prices from 24 guineas to 35 guineas; it is rated for an output of 2½ watts, and is fitted with delayed A.V.C. obtained through a duo-diode-triode valve operating to control the H.F. pentodes in the H.F., first detector, and I.F. stages. A separate oscillator valve is used with a variable-mu H.F. pentode first detector to form the frequency changer, and the I.F. coupling is by means of the resistance-capacity circuit. A tone control and a visual tuning indicator are incorporated.

The Gramophone Co. will be showing their Superhet Concert Seven, model 467, which is fitted with a tone control of unusual character. Instead of operating merely to reduce the high frequency response, it simultaneously increases the bass and reduces the treble or reduces the low frequencies while increasing the upper register,

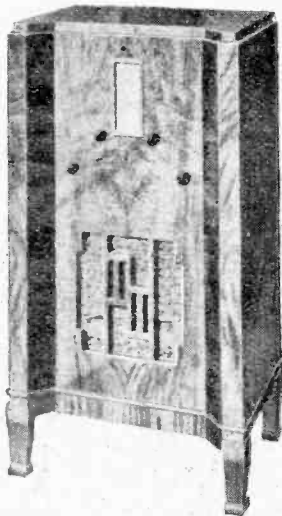

G.E.C. Console superheterodyne.

and so permits an unusually wide range of control to be obtained. A threshold sensitivity control, with a static suppressor switch, is fitted, and the output to the moving-coil speaker is 2½ watts. This firm will also be showing a five-valve radio-gramo-

phone at 29 guineas, and there will be a ten-valve superheterodyne in radio-gramophone form with an automatic record changer at 80 guineas, so that models to suit all tastes can be found.

In most cases the intermediate frequency is fixed at some 110 kc/s to 125 kc/s, but in one receiver the high value of 473 kc/s is employed. This is in the Alba superheterodyne, and because of it a single signal frequency tuned circuit can be used without any increase in second channel interference.

The circuit is arranged as a detector-oscillator, a variable-mu I.F. stage, with an anode bend second detector resistance coupled to the output pentode. It is priced at 13 guineas, and a D.C. mains model will be available.

Bush Radio also have a four-valve receiver, but here a more normal intermediate frequency is employed, and a band-pass input circuit is provided to the detector-oscillator. There is a single I.F. stage with an anode bend second detector feeding a pentode output valve rated to deliver 3 watts to the loud speaker. The mains equipment includes a metal rectifier.

Receivers for A.C. and battery working will be shown by Higgs; the model Super A is for A.C. mains and gives a 3 watts output and automatic volume control is fitted. The Super B is for battery operation, and is also fitted with A.V.C.; the output is

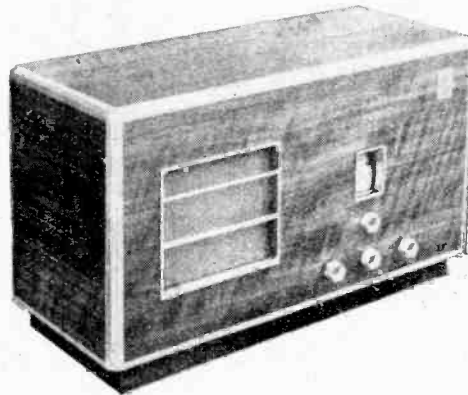

Kolster-Brandes 6-valve receiver.

1½ watts, and the price of 18 guineas includes the moving-coil speaker and batteries. This model is also available in radio-gramophone form.

Ultra Electric will show a wide range of receivers. The Tiger chassis is available in a variety of cabinet styles, and in slightly different models for A.C., D.C., or battery working. The mains models have four valves, apart from the rectifier in the case of the A.C. set, arranged as a detector-oscillator, a variable-mu I.F. stage, a screen-grid second detector, and a pentode output valve. The battery set is similar, but a driver valve is inserted between the second detector and the Class "B" output valve. The larger receiver marketed by this firm, the Panther, includes seven valves, and is for A.C. operation; there are two I.F. stages with a duo-diode-triode second detector, and a two-valve frequency changer.

Kolster-Brandes will have a four-valve superheterodyne and a six-valve model fitted with A.V.C. and automatic tone correction. Their eight-valve receiver has a system of

quiet automatic volume control, known as an inter-station noise suppressor, which is arranged through the combination of a duo-diode-triode with a single-diode-tetrode valve. The output stage consists of two pentodes in push-pull, giving an output of 5½ watts. All receivers of this make are designed for operation from an aerial with a screened lead-in for reducing "man-made static," and the additional equipment for this will also be on view.

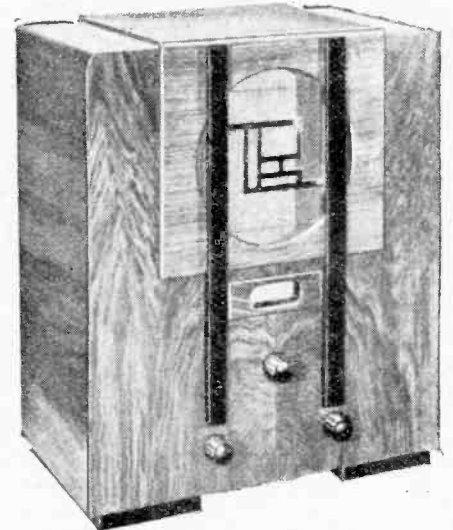

Bush Radio table model.

Although most A.V.C. systems will be arranged with the aid of the duo-diode-triode valve, this does not mean that they will all be identical. Perhaps the majority of sets are using it to give delayed diode A.V.C., but in the six-valve Radio Instruments receiver it is employed for amplified automatic volume control. In the Pye portable superheterodyne, however, metal rectifiers are used to provide automatic volume control; as might be expected, this set is fitted with a frame aerial and the output stage is of the Class "B" type. Variety is also to be found in the Q.A.V.C. systems; although it is the common practice to use a combination of a duo-diode-triode and a triode, some firms are using metal rectifiers.

D.C. Mains Sets

Examples of nearly every superheterodyne type will be found on the General Electric Co. stand. The smallest is represented by a five-valve model with an input band-pass filter to the detector-oscillator frequency changer, an I.F. stage, a screen-

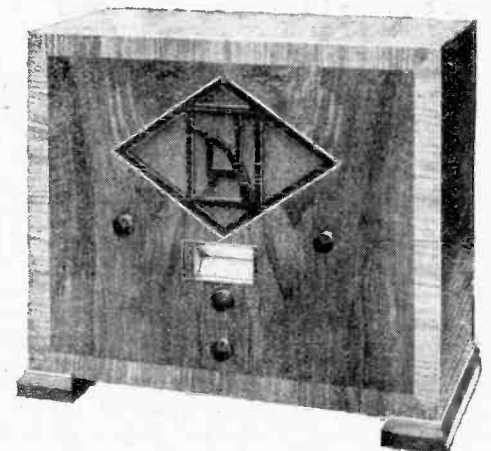

Ultra Electric "Panther" table model

What to See at the Show.— grid second detector, and a pentode output valve. A similar set is available for D.C.



Ferranti "Gloria" companion model.

mains, and this is provided with a barretter for regulating the heater current to the D.C. mains valves. Another model, but with six valves, is arranged for battery operation, and here Class "B" output is naturally used with the new B.21 valve; the output is rated at 1,200 milliwatts. The intermediate frequency is 125 kc/s, and a special arrangement is employed in the input band-pass filter for the suppression of second channel interference and similar whistles.

Q.A.V.C.

The larger model of this firm is provided with eight valves, and there is a variable- μ H.F. stage with two signal frequency

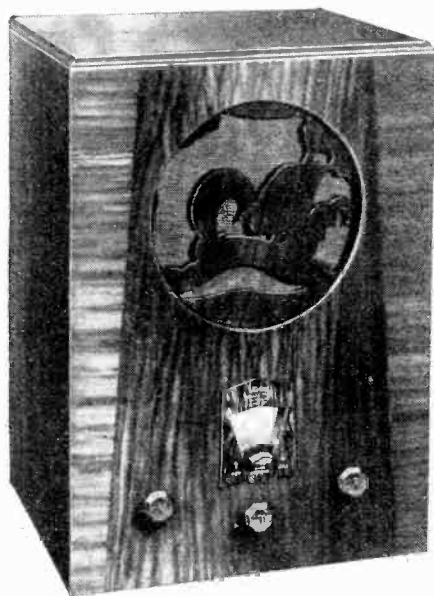

Varley 5-valve superheterodyne.

tuned circuits; the chief feature, however, is undoubtedly the system of quiet automatic volume control in which a duo-diode-triode valve is used in conjunction with a separate triode for noise suppression. With the Q.A.V.C. circuit, of course, the set is quite dead until it is tuned accurately to a station. The receivers are all available in different cabinet styles, including radiogramophones.

An unusual feature to be found in the

Marconiphone model 290 is the employment of a metal rectifier for the A.V.C. system; this receiver is of the seven-valve type with variable- μ H.F. and first detector stages. There is a separate oscillator valve and a static suppressor is included; the output is rated at 2½ watts, and an automatic record changer can be fitted.

Battery Sets

The model 272 is a five-valve set with a constant-peak input band-pass filter to the screen-grid detector-oscillator, which acts as the frequency changer. A single I.F. stage is used, with a power grid detector auto-transformer coupled to the output pentode. This model is priced at 15 guineas. A battery portable superheterodyne will also be shown, and it includes a moving-coil loud speaker, while the total anode current is stated to be only 10 mA.

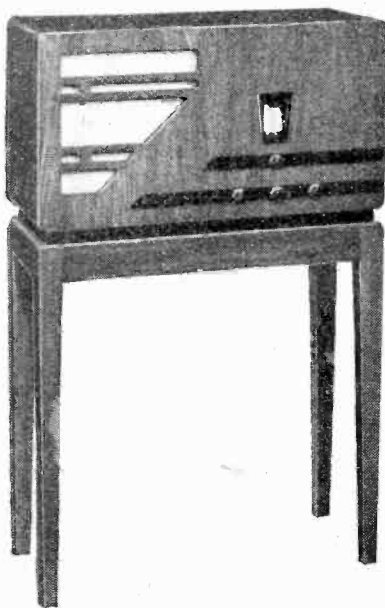

Standard 60 superheterodyne.

Sunbeam Electric will be showing what is essentially a four-valve superheterodyne in A.C., D.C., and battery forms. In all cases there is a detector-oscillator for the fre-

quency changer, a single intermediate frequency stage, and the second detector. The A.C. model has a pentode output valve, and there is in addition the H.T. rectifier, but

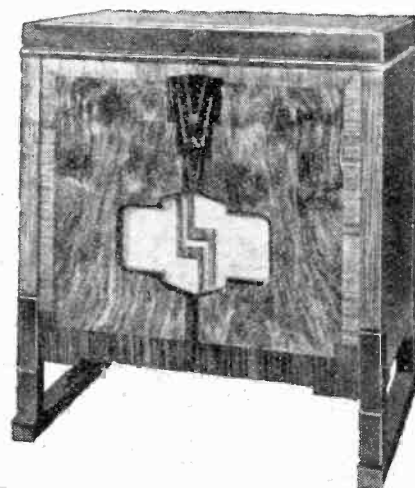

H.M.V. Console, Autoradiogram.

in the D.C. set there is, of course, only the pentode output valve. The battery receiver, however, has two L.F. stages, since with Class "B" output it is necessary to employ a driver valve. All models bear the same price of 13 guineas.

A very wide variety of receivers will be found on the Columbia stand, although the differences lie more in the cabinet work and gramophone equipment than in the actual radio chassis. The Autoradiograph De Luxe Ten, model 640, is a ten-valve A.C. set with delayed automatic volume control, moving-coil loud speaker, automatic record changer, and a tuning scale calibrated in both wavelengths and stations. It is priced at 90 guineas, but a smaller model of the seven-valve type, also fitted with D.A.V.C., is available at 43 guineas.

Standard Telephones will have two superheterodynes on view. The Standard 40 is a four-valve model with a moving-coil speaker, while the Standard 60 is fitted with six valves. These sets naturally use Micromesh valves, and the latter includes automatic volume control obtained with the aid of a duo-diode-triode detector valve.

STRAIGHT SETS

THE "Superinductance" receivers with two tuned H.F. stages made by Philips have always been a thorn in the side of partisans of the superheterodyne principle of reception, and improvements which have been made in this year's models will undoubtedly keep this perennial controversy open for some considerable time to come.

The star receiver in the Philips programme this season will be the model 636A. Designed for A.C. mains only, this receiver has seven stages, excluding the rectifier. There are two variable- μ screen grid H.F. stages with a band-pass input circuit and tuned coupling transformers of the high-efficiency "Superinductance" type, a screen grid detector, a combined single diode and screen grid amplifier valve for automatic volume control, a high magnification triode for silent tuning between stations, a triode L.F. stage, and a 7-watt pentode output valve. A three-position control is included so that the set can be adjusted to operate silently under any conditions of local interference. In the third position maximum

sensitivity without silent tuning is provided for long-distance reception enthusiasts.

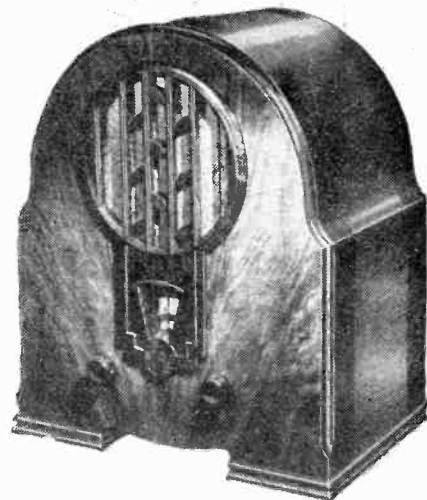

Philips Model 634 "Superinductance" receiver.

What to See at the Show.—

The Philips 634 receiver is another set employing two H.F. stages with four tuned circuits. It does not incorporate the luxury of silent tuning, but automatic fading compensation is provided by a diode S.G. detector-amplifier valve. This set is available for A.C. or D.C. mains, and in the D.C.

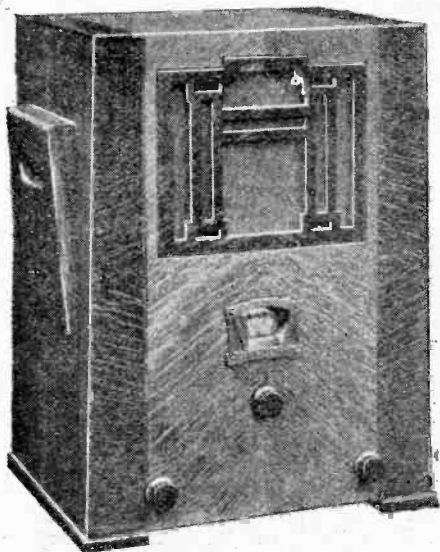

"Alba" Model 222 Class "B" receiver.

set two pentodes in parallel are used in the output stage, from which an excellent power output is obtained on D.C. mains voltages as low as 110. The Philips exhibit will also include an inexpensive battery receiver, the 832B, with one tuned and one semi-aperiodic stage. This receiver is based on last year's 830B model, in which, it will be remembered, the H.T. consumption is controlled to minimise waste during periods when the transmitter is not modulated. The set is now supplied with a moving-coil loud speaker in a cabinet of new design. The range is completed by the 834, also with one tuned and one aperiodic H.F. stage.

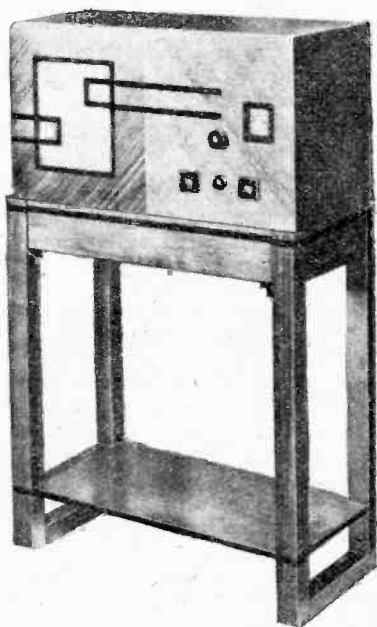

Climax T.C. III mains transportable and pedestal.

This set, which is based on the 830 receiver of last year, is available for A.C. or D.C. mains. As in the case of the 634 receiver, parallel pentodes are used in the output stage of the D.C. model.

Another good example of a straight receiver employing two variable-mu screen grid H.F. stages is the Cossor Model 735. This receiver is designed for battery operation, and the H.F. valves are followed by a detector, a driver valve, and Class "B" output stage.

Single-stage H.F. Sets

Once again the general-purpose type of receiver, employing a single screen grid stage, followed by a detector and L.F. amplifier, will be well represented at Olympia. Dealing first with mains-operated sets, the following examples will serve to indicate the new standard of value which will be offered in this class.

Messrs. A. J. Balcome, Ltd., will be showing their Model 50 all-mains receiver, including a variable-mu H.F. stage, screen grid detector, and pentode output valve with energised moving-coil loud speaker at £11 19s. 6d.

The Bush Radio A.C. Three will again be shown at the reduced price of £11. The new Clarkes "Atlas" A4 table model is another receiver employing this arrangement of valves and has a rated output of 3 watts. The price is 12 guineas.

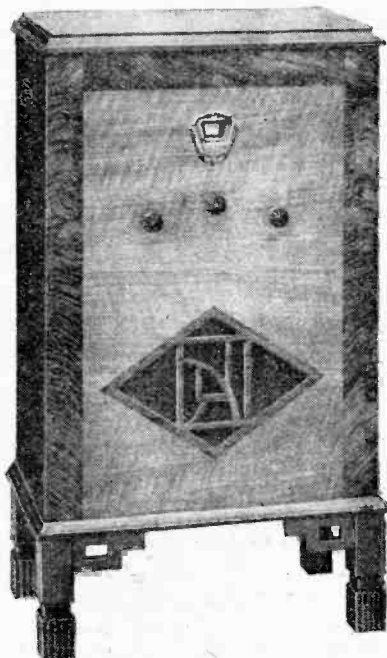

Ultra "Lynx" Consolette model.

The Cossor Models 3468 and 3469 for A.C. and D.C. mains respectively are pedestal models at £9 19s.

Climax sets are represented in this category by the T.C. Three Transportable, which, with band-pass tuning and moving-coil loud speaker, sells at 14 guineas.

The Columbia 355 All-electric Four and the H.M.V. 436 de Luxe Radio-Four are also outstanding examples of general-purpose sets employing four valves, taking into account the rectifier, the price in each case being 12 guineas.

The well-known Kolster-Brandes K.B.321 receiver will again be shown practically unchanged, but the R.I. "Madrigal" all-mains set has been redesigned and now makes use of dust-core tuning inductances. Another three-stage receiver employing iron core coils is the Telsen 464. This receiver includes tone control, and sells at the very reasonable price of 9 guineas.

The Model AP34 receiver to be shown by Varley is a band-pass tuner incorporating

the well-known square peak coils, and with a variable-mu screen grid H.F. valve and a pentode and output stage is priced at 12 guineas.

In the Ultra range of receivers the general-purpose sets are known as the "Lynx" series and are housed in cabinets of striking design. The same base and chassis will be shown in table, model, consolette, and radio-gramophone form.

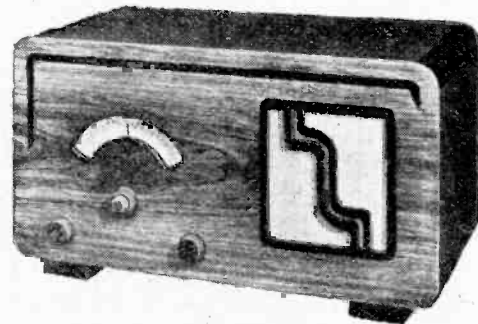

New Atlas A4 receiver.

This year, thanks to the introduction of Class "B" and Q.P.P. amplification, the number of battery receivers will show a marked increase over previous years. All the following sets will include a screen-grid H.F. stage, and while in many cases existing sets with plain triode or pentode output valves are being continued, their prices have been reduced, so that they represent extraordinarily good value for money. In the latter class, for instance, there is the Alba Model 22 which, with balanced armature loud speaker, sells for £9 19s. 6d. The equivalent Model 222, with the addition of a driver valve and Class "B" output valve, is a new model with a permanent-magnet moving-coil loud speaker, and will sell for 12 guineas. This set is also available in radio-gramophone form with a spring motor at 18 guineas.

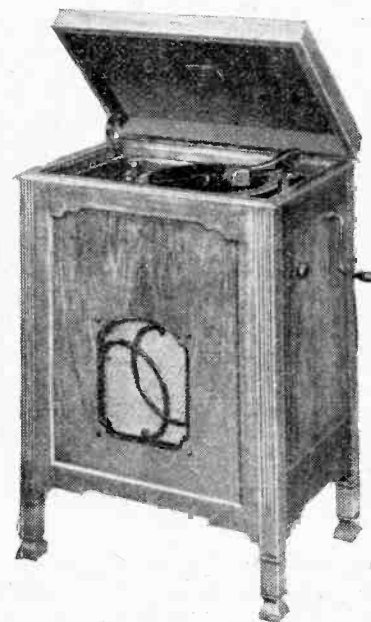

Columbia "CQA" Radiogramophone.

The Clarkes "Atlas" "Lambda" receiver is being continued at £9 15s., and includes many detail refinements in the circuit. A new model, the B4, with a Class "B" output stage giving 1½ watts, will also be shown. In the Cossor range, the equivalent mains set already described, is the

What to See at the Show.—

Model 3456, a review of which appears in this issue.

The C.A.C. exhibit will include the "Oxford" Class "B" Ferrocart 4, which is based on *The Wireless World* Class "B" Ferrocart receiver.

The principal battery receiver in the Columbia range is the "C.Q.A. Battery Four," which incorporates a modified form of quiescent push-pull pentodes in the output stage. The set is fitted with a permanent-magnet moving-coil loud speaker, and the undistorted power output is of the order of 1½ watts. The price of the table model, 1001, has been fixed at 11 guineas, and there is a radio-gramophone version in a full-size cabinet incorporating the new

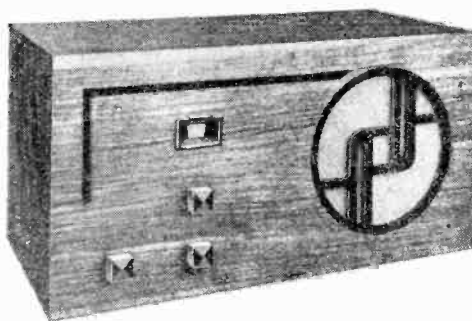

Burgoyne "Class B Three" receiver.

Model 30B, which will be shown by Standard Telephones and Cables, Ltd. This set has a straightforward H.F. detector-pentode circuit, and with an adjustable moving-iron type loud speaker sells for £5 12s. 6d.

Detector L.F. Sets

For the man who is interested primarily in reception of the local station, there will be a wide choice of simple and inexpensive sets consisting of a reacting detector followed by one or more stages of L.F. amplification.

Burgoyne Wireless, Ltd., are specialising in sets of this type for battery operation, and have produced a most attractive series in modern style cabinets: The "Popular" model with a detector-2 L.F. circuit and moving-iron type loud speaker is a self-

the "R. & R." Class "B" Three, and is fitted with a permanent-magnet moving-coil loud speaker.

With the backing of a firm of the standing of the G.E.C., their new battery M.C.3 receiver, which sells for £5 17s. 6d. complete with batteries and moving coil loud speaker, is assured of a favourable reception among those in search of a sound but inexpensive set. The circuit consists of a detector, a low-frequency amplifier, and a pentode output valve.

Standard Telephones and Cables, Ltd., will be showing a two-valve battery set with moving-iron loud speaker, in which

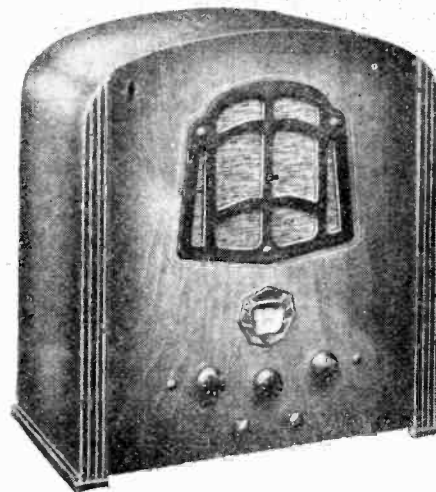

G.E.C. Battery M.C.3.

automatic bias is provided, and showing that the best possible performance is obtained at all times during the discharge of the H.T. battery. Simple two-valve sets for A.C. and D.C. mains, such as the models S322 and S320, will also be found on this stand.

The "Cambridge A.C.2" to be shown by C.A.C. is a receiver of unusual technical merit. The single tuned input circuit contains a coil of the Ferrocart type, and the detector is one of the new high efficiency screen-grid pentode valves. The output valve is a Catkin pentode.

SPECIAL SETS

THE needs of the average listener are met by the ordinary type of broadcast receiver, which has been discussed in the preceding pages. Although there is nothing approaching standardisation in this matter, an "ordinary broadcast receiver" may, without being dogmatic, be described as one which covers the medium and long broadcasting wavebands, and which is primarily intended to operate with an external aerial.

There is, in addition, a minority—but by no means a negligible one—which requires something rather less conventional. For instance, a completely self-contained set with a built-in frame aerial may be considered essential in certain circumstances, either because portability is desired, or because it is impossible to erect a reasonably efficient type of aerial. Again, an increasing number of listeners are discovering the attractions of the short and ultra-short bands, and the newer applications of wireless, such as motor car radio, are making progress. All these interests, and those of the "kit" constructor as well, will be amply catered for at the Show.

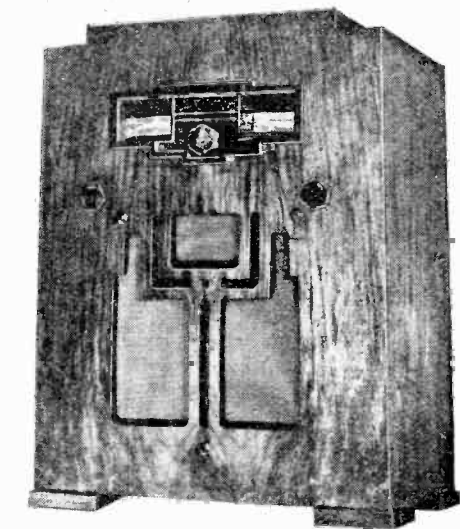

Marconiphone Model 260 with push-pull pentode output stage.

Columbia pick-up and double-spring motor, which is extraordinarily good value at 20 guineas. A new and inexpensive battery set, known as the "M.C. Battery Three," has also been added to the Columbia list, and with a straightforward H.F. detector-pentode circuit and permanent-magnet loud speaker is priced at £8 15s.

With the introduction of Class "B" amplification, a battery version of the Madrigal receiver has been produced by R.I. This set, like the mains equivalent, makes use of dust-core tuning coils.

In the Marconiphone Model 260, we find another example of push-pull pentodes in the output stage. The arrangement is described as "P.C.P." (the "parallel conductance principle"), and is a modified form of Q.P.P. The set, with a permanent magnet loud speaker, is housed in a cabinet which maintains the Marconiphone reputation for high-grade finish and will sell for £11 15s. 6d.

A really low-priced set with the backing of a firm of high reputation is the Standard



Slektun "R & R" All Electric Twin.

contained receiver with frame aerial, costing £3 17s. 6d. complete. The "Olympic 3" employs the same type of circuit, but is designed for use on an outside aerial. A moving-coil loud speaker is used and the price is the same as that of the "Popular" model. The cabinets are rexine-covered, but de luxe chassis-built models with polished cabinets are available, the price in each case being 4 guineas. The receiver on this stand which is likely to attract the most attention, however, is the new "Class B Three." The circuit consists of a detector, driver valve and Class "B" output valve, and the price, complete with moving-coil loud speaker, is £6 10s.

Slektun Products, Ltd., will also be showing a receiver in which a reacting detector is followed by a driver valve and Class "B" output. The set is known as

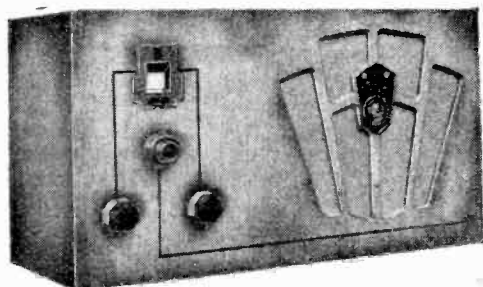

Standard Telephones "30B" receiver.

What to See at the Show.—

Among the most interesting of the new portables is the Pye P/B, a six-valve battery-operated superheterodyne, completely self-contained with a frame aerial. The valves operate as signal-frequency H.F. amplifier, combined oscillator-first detector, I.F. amplifier, driver, and class "B" output; the second detector is a Westinghouse metal rectifier, and is arranged to give delayed automatic volume control, which comes into operation as soon as the class "B" valve is fully loaded. This set is fitted with a moving-coil loud speaker; the price is only 14 guineas. Other interesting superheterodyne transportables, also fitted with moving-coil loud speakers, are to be shown by H.M.V. and Marconiphone.

Suitcase Portables

Turning to "straight" sets of the truly portable type, it will be found that the McMichael suitcase model (the Duplex Four) has been brought up to date, and is now fitted with a moving-coil loud speaker. Other battery and mains sets, similarly self-contained, are to be shown.

Iron-cored tuning coils are employed in the tuning circuits of the new Beethoven suitcase model, which employs a high efficiency pentode valve, and, again, a moving-coil loud speaker.

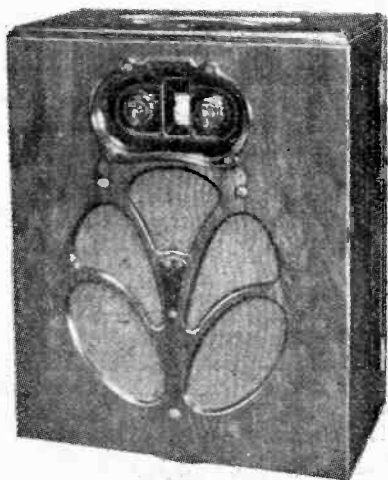

A portable battery-fed superheterodyne by H.M.V.; a moving-coil loud speaker is fitted.

As is to be expected, Class "B" amplification will figure in a number of the new battery portables and transportables. Among the new sets of this type is the Portadyne Model P.B.5, for which an output of 1,300 milliwatts is claimed for a standing anode current of between 7 and 8 milliamperes.

Frame aerials are not confined entirely to portable sets, or even to those with comparatively ambitious H.F. circuits. Burgoyne and Shalless & Evans are both to show a range of self-contained detector-L.F. frame aerial sets at extremely low prices. Naturally, receivers of this type have a limited, but nevertheless very useful, range of reception.

"Paraphase" Amplification

Amplifying equipment, in many cases combined with turntables, record-changing mechanism, and a microphone for public-address work, will be shown by several firms. The R.G.D. 12-watt A.C. outfit, Type W12A, is especially interesting in view of

the fact that, although resistance-capacity coupling is used throughout, a push-pull output stage is employed. This, of course, implies the use of a phase-changing valve. An



A real portable: the new McMichael set.

automatic record changer is supplied with the equipment in its standard form.

Two amplifiers rated in terms of their D.C. anode dissipation at respectively 25 and 50 watts have been produced by Birmingham Sound Reproducers, Ltd. These give an undistorted output of about 6 to 12 watts, and employ screen grid valves as amplifiers with resistance-capacity intervalve couplings. It is interesting to note that a two-stage H.F. radio chassis designed to work with these amplifiers is to be shown.

Film Industries, Ltd., are to show simple, compact, and relatively inexpensive public address outfits, complete with microphone, and entirely self-contained. The C.A.C. six-watt amplifier includes a scratch filter, and is primarily intended for gramophone work; it gives an output of 6 watts.

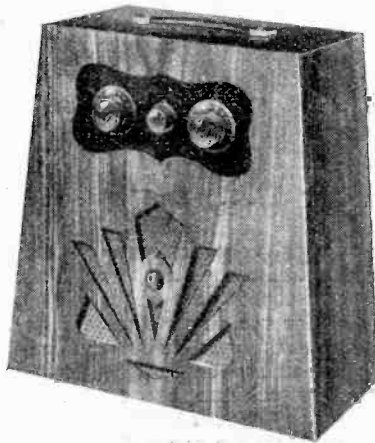

The Shalless and Evans detector-L.F. set includes a built-in frame aerial.

Although full details of all the short-wave apparatus to be exhibited have not yet reached us, enough information is available to justify the statement that this specialised branch of wireless activity is not to be neglected. Halford Radio, Ltd., announce the introduction of no fewer than five special short-wave sets designed mainly for overseas

use. The same firm are also producing a series of all-wave receivers (long, medium, and short) which will be of equal interest to listeners in this country. The R.I. Antinodal Short-wave Converter is available in a form suitable for operation on A.C. mains, in addition to the battery-set adaptor.

The Eelex short-wave converters for this season are supplied both for A.C. and battery operation, and with or without an H.F. stage preceding the autodyne frequency changer.

As most of our readers are aware, the firm of Stratton & Co. have for some time specialised in short-wave work, and although details of their programmes for this season have not yet been made public, it is known that several interesting Eddystone short-wave productions will be exhibited.

Kit Set Developments

Among the new kits introduced this season is the new Cossor Melody Maker, a particularly cleverly designed receiver, which will be available in several different forms. The simplest version, a standard three-valve battery model with a high-efficiency pentode output valve, is to be available with either moving-iron or moving-coil loud speakers. The chassis is of gun-finished

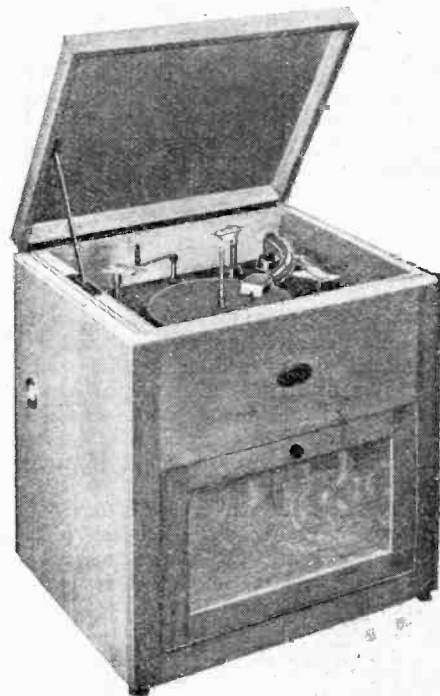

R.G.D. amplifying equipment, with resistance-coupled push-pull output.

blued steel, and, by the inclusion of a fully screened coil unit, wiring is greatly simplified. The set includes a variable-tune H.F. stage, and is particularly attractive externally, the cabinet being arranged in the modern style with the loud speaker at the side; there are few better-looking sets, ready-made or in kit form.

As Cossors were pioneers of Class "B" valves, it is only natural that there should be a Melody Maker with this form of amplification on the same chassis.

Another interesting kit set is announced by Lissens; their well-known "Skyscraper" model has been entirely redesigned in order to include reception of short waves in addition to the medium and long broadcasting bands. Recent "Wireless World" sets, including the New Monodial, are to be featured in "kit" form by C.A.C.

What to See at the Show.—

Although it is not, properly speaking, a kit set, the demonstration superheterodyne exhibited by Westinghouse should be mentioned; this set is intended to show the use



B.S.R. amplifier and dual gramophone turntables.

of the new Westector as a combined second detector and A.V.C. device.

Haynes Radio sets are available as complete receivers, bare chassis, or as kits of parts. All are mounted on aluminium base-plates finished to match the general colour scheme, and have full-vision tuning scales, uniform control knobs, and Ferrocart coils throughout, even in the I.F. circuits of the superheterodynes. The Haynes Quality Receiver, embodying an almost ideal specification for medium-range reception with high quality and generous output, appears this year in slightly modified form with the new compact Ferrocart coils. Among the most ambitious of the new sets is a superheterodyne available either for A.C. or D.C. mains. For this set a two-valve or a single-valve "Pentagrid" frequency-changer is available, and the second detector is a double-diode triode, arranged to give amplified and delayed automatic volume control. Another new Haynes receiver is a short-wave superheterodyne embodying a signal-frequency H.F. stage before the autodyne detector-oscillator.

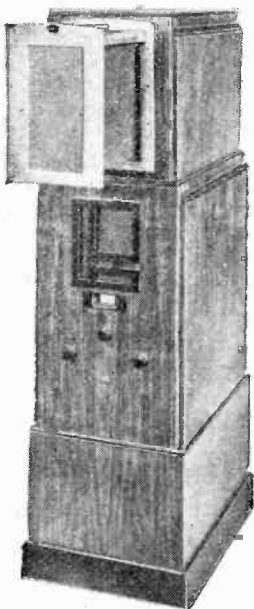

The screen of the Bush Radio television receiver fitted immediately above the loud speaker.

Those who are still using out-of-date sets through uncertainty as to changes in the form of their domestic electrical supply will be interested in the "universal" sets which work equally well on either D.C. or A.C. The Sunbeam series are illustrative of what may be done in this direction; several distinctive models are available, including a

"midget" set measuring no more than 11 in. wide and 8 in. high. An H.F.-det.-L.F. circuit is included, the output valve being a pentode, and the set works on any mains supply between 200 and 250 volts. A 25 ft. aerial is included with the set, and an output of over 1 watt is obtained. The cost of this little set amounts only to seven guineas. Other Sunbeam sets of conventional size, but embodying the same "universal" feature with regard to mains supply, are offered at eight and nine guineas. Grafton Radio are also expected to show "universal" sets, including superheterodynes.

Special Car Sets

It seems certain that several special sets, designed specifically for fitting in a car and for operation while the vehicle is in motion will be exhibited. Page Car Radio are expected to show a superheterodyne including such desirable features as automatic volume control, a signal-frequency H.F. stage, and a remote control device whereby the set may be operated from any convenient point in the car, though it may be mounted in an inaccessible position. Unlike American car sets, provision for long-wave reception is made. Another set, of

simpler type, employs a "straight" three-valve circuit, and there is also an inexpensive "baby" car receiver, for headphone reception, which operates on 12 volts H.T., derived from the car battery.

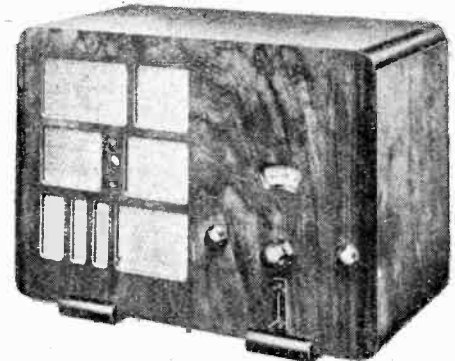

The latest Cossor Melody Maker; a new departure in kit sets.

A television receiver, completely self-contained with projector and amplifier, is to be exhibited by Bush Radio. In this instrument the screen is mounted above the loud speaker at a convenient height,

LOUD SPEAKERS

IT may be safely predicted that, from the point of view of numbers and also in general technical merit, the display of loud speakers at Olympia this year will be better than anything that has been seen before. The small moving-coil unit will still be the best represented, but there is every indication that a wider choice will be offered to those in search of the larger and more expensive types. Loud speakers incorporating Class "B" output stages are being shown by a number of firms, and in the majority of cases universal output transformers have been modified to extend their scope to Class "B" amplification.

Small Moving Coils

One of the most interesting exhibits will be the new range of Ediswan-B.T.H. R.K. reproducers. In addition to the well-known 10 in. Senior R.K., there will be two entirely new models, the "Major" (8 in. cone) and the "Minor" (6 in. cone). The new units

cept in dual units, and a new energised model, the E.8, takes the place of the D.C.8. Centring spiders have been strengthened and air-gap clearances have been increased with larger field magnets. A new range of cabinets of modern design has been introduced.



Rola Type F.R.5-P.M. unit.

The standard Rola F5 (6 in.), F6 (7 1/2 in.), and F7 (9 in.) groups of units and dual-balanced pairs afford a very wide choice for individual requirements, and can now be supplied with output transformers for Class "B" valves.

Magnavox loud speakers will this year be exhibited on the Benjamin Electric stand. There will be several new models, including two permanent magnet units—the Standard Type 254 with 7 in. cone and the Senior Type 252 with 9 in. diaphragm. In the re-designed Type 152 energised models a new design of magnet with a U-shaped yolk has been adopted. In these models, as well as in the case of the permanent magnet units, the familiar Magnavox grille is omitted, and the centring spider is fitted behind the diaphragm. The permanent magnet units will be supplied in a sealed dustproof bag, and will be guaranteed for one year if the seal is unbroken.

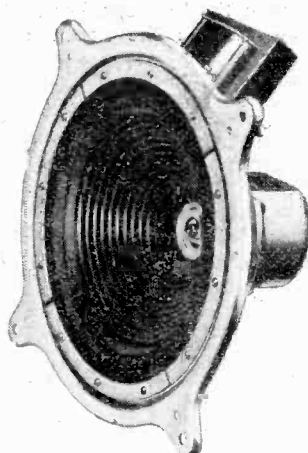

Ediswan "Major" R.K. loud speaker.

are very robustly designed, and all metal parts are cadmium plated.

The Celestion range has been entirely revised. The Soundex is discontinued ex-

What to See at the Show.—

In addition to the well-known Junior, Standard and Senior units and dual-matched pairs, Sonochorde will be showing a new Baby PM at a very attractive price,

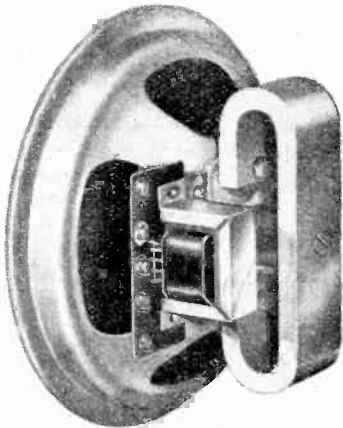

The new Magnavox Type 252 permanent magnet unit.

and a new series of de luxe models with a two-tone green crystalline finish.

A new "Super Dwarf" unit, suitable for portable sets and car radio, will be an important exhibit on the Epoch stand. This firm is also showing a new version of the well-known A2 unit.

Reproducers and Amplifiers will again be showing their "Bantam," "Challenger," and "Victor" units, and, in addition, an entirely new model to be known as the "Alpha." At the time of writing, technical details of this unit are not available.

Under the new management the "Silver Ghost" series of the Lamplugh concern has undergone complete revision. A new diaphragm material known as "Tone Tex" is being used, and a choice of diaphragms of different tone quality is available for each of the four different models now being manufactured. An ingenious quasi-resonant baffle will also be seen on this stand.

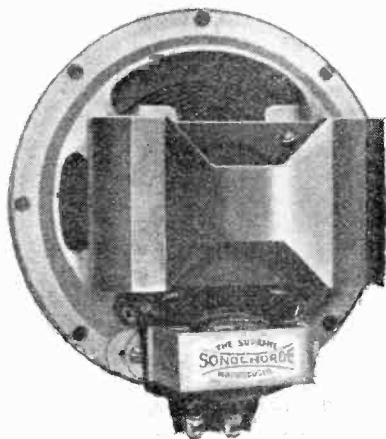

Sonochorde "Midget" loud speaker.

Ferranti will be showing a new and inexpensive permanent-magnet unit known as the M5, and two new energised models, the D4 and D5. A universal cabinet of very beautiful design has also been introduced to house these units.

The W.B. range of speakers made by Whiteley Electrical Radio will be fitted with a new type of output transformer incorporating a switching arrangement giving more than usually accurate matching to the power valve. The new device will be known as the "W.B. Microlode."

A new energised model will be found on

the Blue Spot stand, where the well-known 29 PM, 45 PM, and 99 PM units and cabinet models will also be available for inspection.

Amplion are showing two models this year, the "Audiola" and a new model for the constructor known as the "Sonette."

A very interesting permanent-magnet unit, specially designed for car sets and small portables, will be shown by Goodmans. The depth is only 2 3/4 in., and the entire chassis is included in the magnet system.

Two other exhibits which will well repay a visit are the new Igraic D9 unit and the

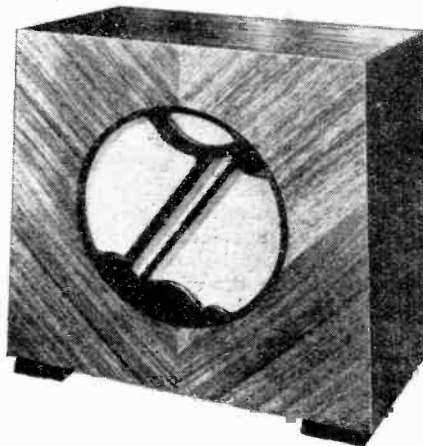

Whiteley Electrical P.M.4A cabinet loud speaker.

Ormond R/494 P.M., which is fitted with what is now an unconventional cylindrical-type permanent magnet.

The Gramplan range of small moving coils is unusually comprehensive this year, and not the least interesting item of this exhibit will be the new baffle cabinet for home construction.

Class "B" Speaker-Amplifier Units

The extra power obtainable from Class "B" output valves compared with that obtainable for the same current consumption from ordinary triodes or pentodes often produces a marked improvement in the performance of a small moving-coil loud speaker from the point of view of quality as well as volume. Many makers are ensuring that their loud speakers shall be properly appreciated by incorporating a Class "B" output stage in the loud speaker unit. The unit is connected in the anode circuit of



Baker Selhurst "Permag" Class "B" unit.

the last valve in the set, which then becomes the driver. Examples of this form

of construction will be shown by Baker Selhurst, Celestion, Epoch, Ferranti, Rola, Sonochorde and Triotron (Chlormet).

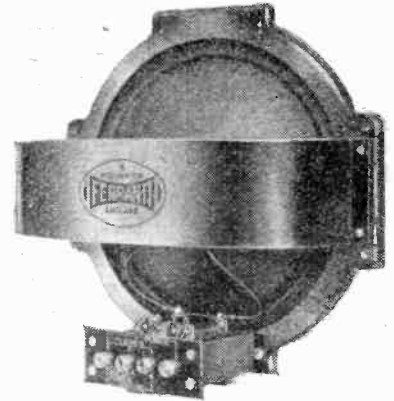

Ferranti M5T permanent magnet unit.

Large Moving Coils

Excellent as is the performance of the small moving coil, there will always be a demand for the more expensive types which can give something better in the matter of quality—more particularly in the base. In this category the range of choice is wider than in previous years.

A new permanent-magnet version of the Ediswan-B.T.H. Senior R.K. will be shown for the first time, and Epoch will be exhibiting a large "Super P.M." model at a popular price. The new Lamplugh de luxe 12 in. "Silver Ghost" is another loud speaker which definitely falls in the high-grade class. Loud speakers of the

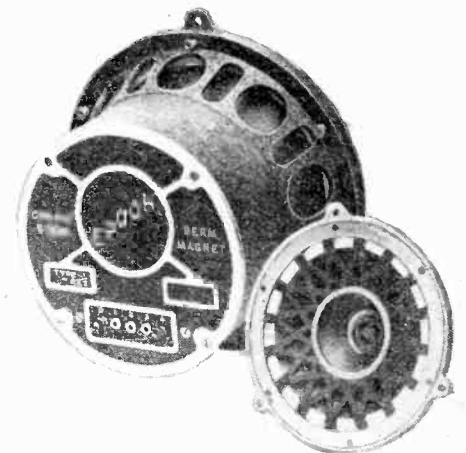

The new Epoch Type A.2. unit.

"auditorium" type will also be shown by Celestion and Sonochorde, while other well-known models which should not be missed are the Ferranti M1, G.E.C. "Senior PM," H.M.V. Model 174, Marconiphone 140 and the new 141, the Baker Selhurst "Super Power" range, and the Gramplan "Senior" type D.P.4.

GRAMOPHONE EQUIPMENT

ALTHOUGH the owner of a radio receiving set may not at first be particularly interested in gramophone reproduction, it frequently happens that the broadcasting of a record of outstanding merit suggests the possibility of extending the scope of his set from the entertainment point of view. It is safe to say that the receiver

What to See at the Show.— itself will be already equipped to deal with the output from an electrical pick-up, and his requirements in the matter of subsidiary equipment will be well catered for by many of the firms exhibiting at Olympia this year.

Pick-ups

The performance of many of last year's leading makes has proved so satisfactory that they are being continued practically unchanged, though prices in general show a gratifying reduction.

A newcomer to the field is the Cosmocord "Universe" pick-up, which incorporates a volume control and is provided with an adjustment by which the needle pressure may be adjusted. The characteristic is of good general form, and there is rather more than the usual rise of output towards the bass.

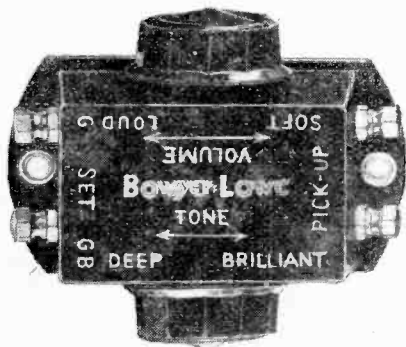

Bowyer-Lowe Tone and Volume Control unit.

Messrs. Belling-Lee will be showing three models, one of which should be of special interest to owners of portable acoustic gramophones. It is designed to clip on to the side of the case, and can be readily detached when it is desired to use the gramophone in the normal way. The other two models incorporate the same movement, and are designed for permanent baseboard mounting—one with, and the other without, built-in volume control.

A new Bowyer-Lowe pick-up—the Mark IV—will be shown for the first time. It is a really high-grade job, and the movement is housed in a felt-lined, moulded case of modern design, the underside of which is metal-lined to screen off motor interference. The frequency range is from 25 to 6,000 cycles, and a choice of characteris-

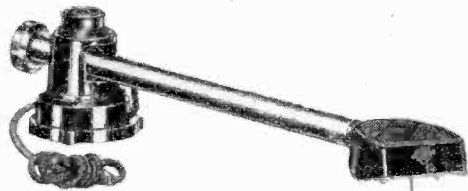

Blue Spot Model 33 Pick-up.

tics is available depending on the type of amplifier equipment with which it is to be used. The Mark III pick-up is now fitted with a volume control incorporated in the base, and the cheaper "Beta" model is being continued as before. A new accessory on this stand which is certain to receive a good deal of attention will be the combined volume and tone control unit, which gives a variable top cut-off down to as low as 1,000 cycles if desired.

Last year's Celestion W8 pick-up has been replaced by an entirely new design—the P2—which incorporates many of the technical features of its predecessor, but has been designed with a view to reducing the costs of production. It incorporates a volume control, and is neat in appearance.

Another new design will be found on the Blue Spot stand, the Model 88 having definitely

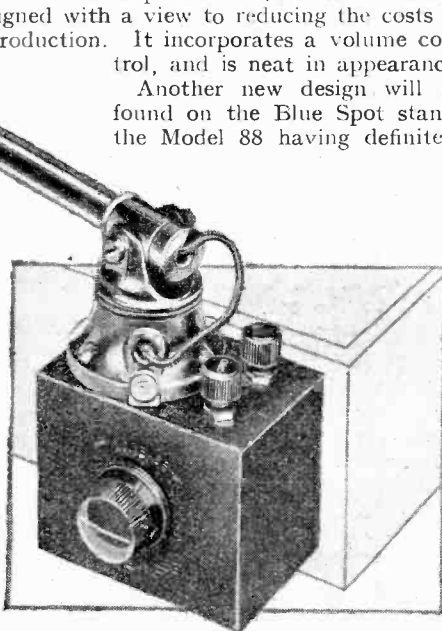

Belling-Lee Pick-up for portable gramophones.

been dropped in favour of the new Model 33 pick-up. It has a frequency response from 30 to 4,000 cycles, and is an excellent example of up-to-date practice.



The new Marconiphone Model K.19 pick-up.

Among well-established makes which are being continued with but minor changes may be noted the Ediswan-B.T.H. "Senior" and "Minor," the Harlie range,

the British Radiophone pick-up, the Garrard and the H.M.V. No. 11 pick-up attachment for existing gramophone tone arms.

Last, but by no means least, entirely new pick-up units will be exhibited by the Marconiphone and Columbia concerns.

Motors and Record Changers

The Garrard Engineering Company will be showing, in addition to their already well-known record changer and range of clock-work and spring motors, a new type of radio-gram unit. This consists of a complete motor plate assembly reading for fixing in the cabinet, and includes a motor and turntable with automatic stop, pick-up and tone arm, volume control, and two needle cups. The rectangular metal base plate is rigid, and measures 16in. by 14in. Everything is lined up and adjusted, and the unit is ready for use after fitting the corner screws. A wide choice of motor types is available, and the units fitted with spring motors should be of special interest to those

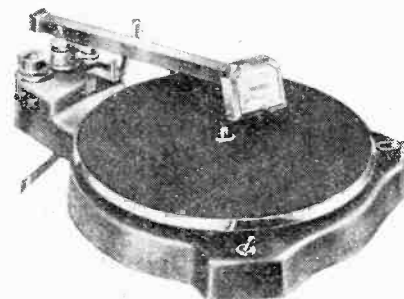

Univolt electric turntable and pick-up.

contemplating the construction of a battery radio-gramophone with Class "B" output.

The Univolt series of electric turntable units, including pick-ups, will again be shown at considerably reduced prices. The compact little Harlie motors will also be continued practically unchanged.

An induction motor of sound design and construction will be found on the stand of the G.E.C., who will also be showing an automatic record changer.

B.T.H. will be showing a new governor-controlled D.C. motor, which will be complementary to the A.C. "Truspeed."

Playing desks and bureaux designed as stands for receivers of the self-contained transportable type will again be shown by the Apollo and Itonia companies.

COMPONENTS AND ACCESSORIES

OLYMPIA will have much to offer the home constructor this year, for, in addition to the usual seasonal improvements to existing components, a host of new items will make their first appearance. The battery set user, in particular, is well favoured, a fact which is accounted for largely by the latest development in Class "B" amplification. Indeed, practically every component manufacturer will have something to show in connection with this arrangement of the output stage.

Class "B" Components

The principal items coming within this category comprise driver transformers, tapped output chokes, output matching transformers, sundry small parts, and complete units for converting an existing receiver to Class "B" working.



Ferranti Class "B" Transformers.

What to See at the Show.—

The Varley series comprise the D.P.40 and D.P.41 driver transformers, each model giving the choice of two alternative step-down ratios. The D.P.42 output choke is tapped, and affords three ratios

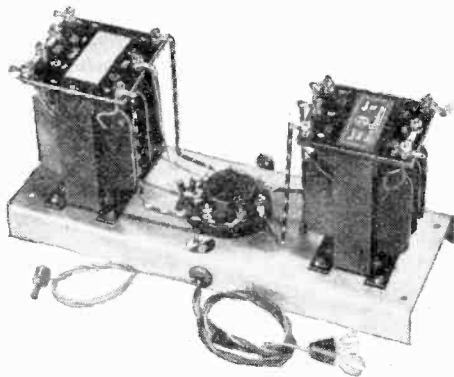

W.B. heavy duty Class "B" converter.

for matching purposes. In addition, Varley will have a range of Q.P.P. components. Driver transformers, with the alternative step-down ratios of two-to-one and three-to-one each half, will be shown by Amplion, Benjamin Electric, Bulgin, Multitone and Telsen, to mention but a few names only.

Class "B" Converters

Ferranti have several single-ratio models in their range, also a large selection of tapped chokes and matching transformers, while further examples of single- and multi-ratio driver transformers and output chokes are to be shown by Baker's Selhurst Radio,

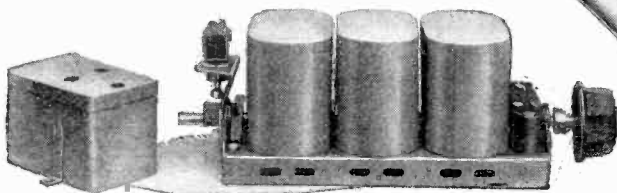

Colvern miniature Ferrocart coils.

British Radiophone, Chorlmet Radio, Igranic, R.I., Sound Sales, Sovereign, and Whiteley Electrical.

The conversion of a battery set to Class "B" working is a relatively simple matter, for in most cases all the additional parts can be accommodated in a unit external to the set, with the result that a number of firms have introduced units for this purpose. Ferranti will show a Class "B" super power converter; Whiteley Electrical (W.B.) have two models, one a small-power and the other a super-power type; while

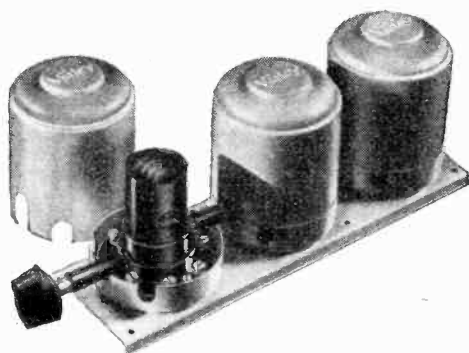

Varley Nicore three-coil unit.

several other examples will be included in the exhibits of Baker's Selhurst Radio, Multitone Electric, Sound Sales, and Sonochorde Reproducers.

Examples of baseboard and chassis-type, seven-pin valve holders for Class "B" valves will be among the products of Benjamin Electric, Bulgin, Clix, Ferranti, Telsen, W.B., and Wearite. The Clix model is of the semi-floating type, and Telsen have adopted an anti-microphonic assembly in one of their models. Belling-Lee will have a neat three-point plug and socket with the centre pin staggered, this having been designed for connecting the loud speaker to the output valve when the former is external to the set.

Coils

Apart from minor improvements and some new additions, the familiar type of small-diameter, air-cored, dual-range screened coils takes much the same form

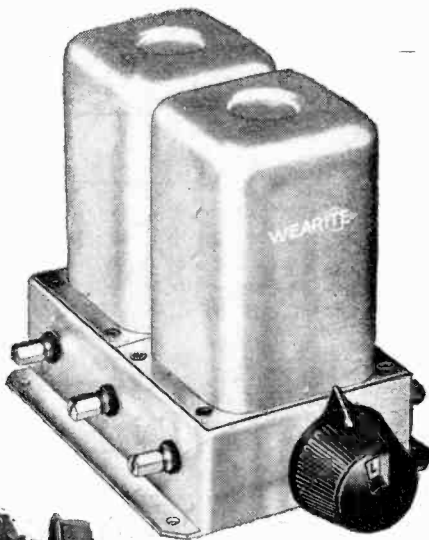

Wearite Nucleon band-pass coil unit.

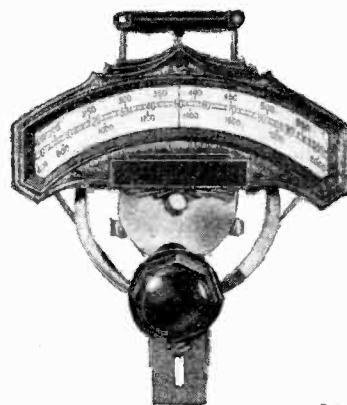

Utility new curved dial.

as hitherto. British Radiophone have now introduced a range of coil units for straight and superheterodyne circuits, and some new band-pass coils are to be shown by Sлектun Products.

The main interest in connection with tuning coils will, however, be the new iron-cored specimens, as exemplified by the Colvern Ferrocart series. There are now no fewer than ten different types in this range,

not to mention the new miniature series just introduced. They have similar characteristics to the earlier designs, but are far more compact, a three-coil assembly, including switching, is accommodated on a base-

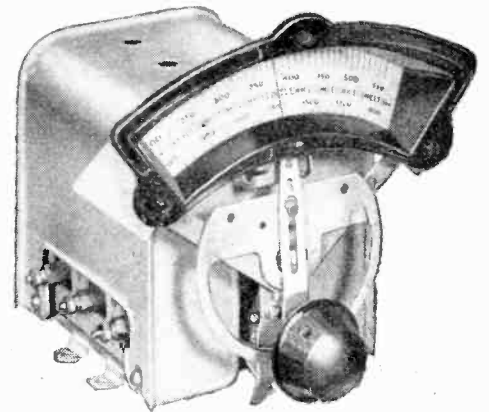

Polar Star Minor three-gang condenser and new drive.

plate measuring 6 1/4 in. long. Some Ferrocart I.F. transformers will probably be on view.

Varley's Nicore series come within the same category, and consist of aerial, H.F., and oscillator coils. These will be shown in ganged units containing up to four coils with switch mechanism. Igranic coils are yet another example of the new practice, but Igranic have extended their range to include the short waves, and one covering 14.8 to 78 metres in two steps is to be shown. Telsen will have some new specimens in miniature form, and the average height is only 2 in.

Nucleon Iron-cored Coils is the designation chosen by Wearite for their new models. These are made in two styles, a Junior and a Senior model; the former has an open iron circuit, but in the Senior models a more complete magnetic circuit is employed for the medium-wave section. The Nucleon range includes several different types of superhet. coils, I.F. transformers, and a screened H.F. choke.

The R.I. Nicrion coils are distinguished by the provision of a control for varying the permeability of the magnetic circuit. It is effected by a change in the position of the core. This offers a simple adjustment for coil inductance, and enables iron-cored and air-cored coils to be accurately

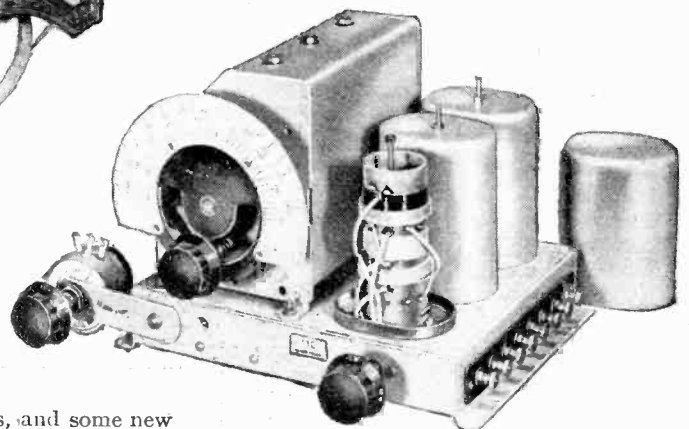

British Radiophone Superhet Radiopak.

matched when a combination of the two styles are embodied in the set. Furthermore, the tuning can be made to agree with a wavelength calibrated scale.

What to See at the Show.—

Variable Condensers and Dials

No radical changes have occurred in the general form of tuning condensers, and the fully screened gang type, but with sundry modifications, will predominate. Jackson Bros. are to show their superhet. gang condensers in two styles, one with the oscillator section in the front, and the other with the tracking vanes mounted in the back section. They are, of course, designed for 110 kc/s I.F. amplifiers. There will be several new full-vision scales, a point of interest being the mounting of the lamp-holder, so that it travels with the cursor, thus giving maximum illumination where it is most useful.

The latest condenser drives developed by Wilkins and Wright (Utility) embody this feature also, and some new and interesting designs of condensers have been introduced for the coming season. The Polar programme includes an extension of their Star series, and a new range described as the Star Minor gang condensers will be avail-

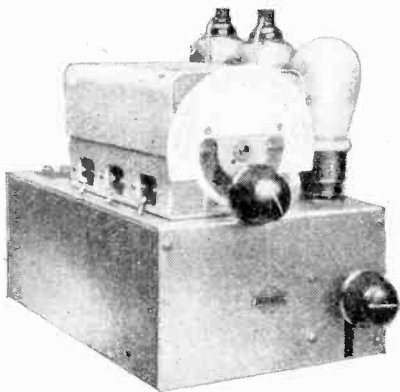

Igranipak, a complete two-H.F. tuning unit.

able for examination. They are more compact than the earlier models, but the same high order of accuracy in matching is maintained. Some new wavelength calibrated full-vision dials have been introduced, and, in addition, there will be a large selection of single, solid dielectric and short-wave condensers. A range of miniature gang condensers, short-wave condensers, full-vision scales, and a single condenser embodying two small fixed condensers constitute the latest additions to the British Radiophone range; Ormond and Ferranti have some examples of the latest practice in condenser design, and Graham Farish have a single model with a loose spindle.

Composite Tuning Units.

British Radiophone have further developed the idea of the composite tuning unit which appeared last year in the form of the Radiopak, and two new models are now available. Both are for use in super-het. circuits; one when an H.F. stage is employed, and the other where an aerial band-pass circuit immediately precedes the frequency changer. The Igranipak Electric Company have developed a unit on somewhat similar lines. Described as the Igranipak it embodies all the essential parts for the H.F. and detector portion of a two-H.F. receiver. Condensers, coils, switching, valve holder, and detector components are mounted on a metal chassis

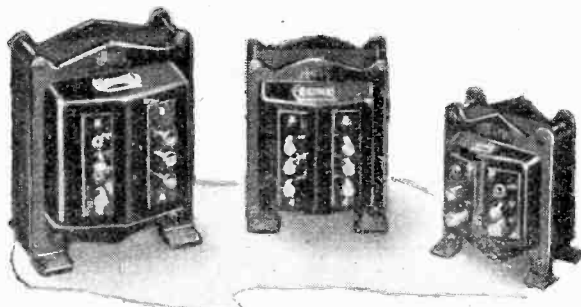

Selection of Heayberd shrouded mains transformers.

wired and ready for fixing to the baseboard.

Of somewhat different form is the new Straight to Superhet. Converter, to be shown by Sound Sales. This consists of a

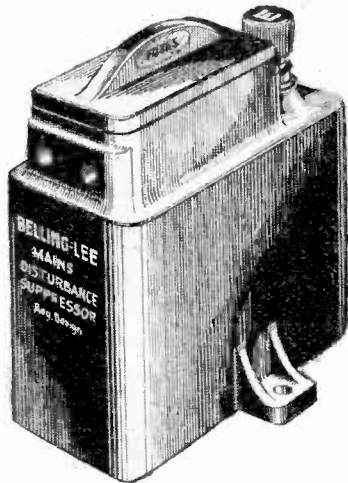

Belling-Lee Mains Disturbance Suppressor.

combined detector-oscillator unit for converting a straight set into a super-heterodyne for normal broadcast use.

Interference Suppressors.

Modern receivers, by virtue of their high sensitivity, have become very much more susceptible to a type of interference often described as "Man-made Static." When this is produced by domestic appliances on

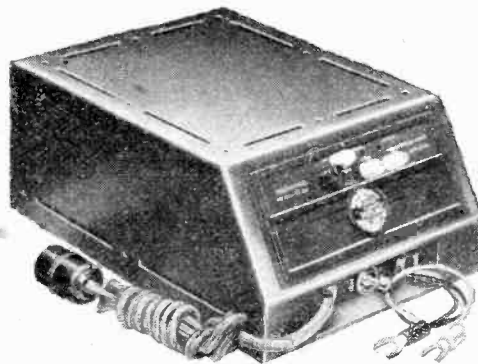

Clarke's Atlas Model T.25 battery eliminator.

the premises it can be cured without difficulty by suppressor devices. Often, however, the interference is generated elsewhere, in which case either a mains filter or a screened aerial down-lead will have to be employed. Thus the several devices to be shown by Belling-Lee, British Blue Spot, Bulgin, and T.C.C. will be of more than usual interest. British Radiophone will, in addition, be showing their Receptru anti-static down-lead, Lamplugh Radio the Silver

Ghost Antistat aerial unit, and Osdue Manufacturing Company the Biflo static cut-out.

Mains Equipment.

H. Clarke & Co. (M/c), Ltd., makers of the well-known Atlas range of battery eliminators, this year have four new units for use with sets embodying Class "B" and Q.P.P. output stages. Better regulation has been obtained and a wider choice of output voltages, particularly at the intermediate tappings, is now available. Further examples of H.T. units will be the Godwinex series made by Dyson, the Ferranti models, and a new range made by Telsen.

Heayberd mains transformers have been improved, many models now being fitted with plugs and sockets in place of terminals,

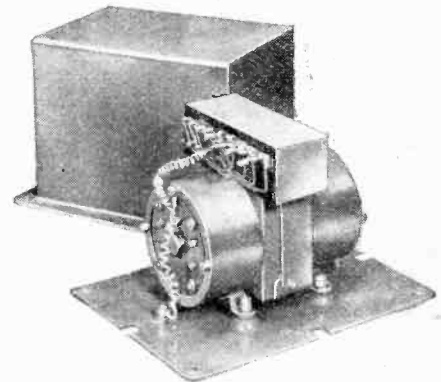

Electro-Dynamic car radio H.T. converter.

and a new series has appeared for use in L.T. battery chargers using Philips rectifiers. Two home chargers for A.C. mains and suitable for radio as well as for car starter batteries have been introduced. Birmingham Sound Reproducers, Bulgin, Ferranti, Igranipak, R.I., Sound Sales, Slektun Products, Wearite and Varley will have further examples of main transformers.

Partridge & Wilson have augmented their range of Davenset station charging equipment, so also has the Lancashire Dynamo and Crypto Company, the last named having a series using valve rectifiers. Station charging equipment will be shown, also, by Newton.

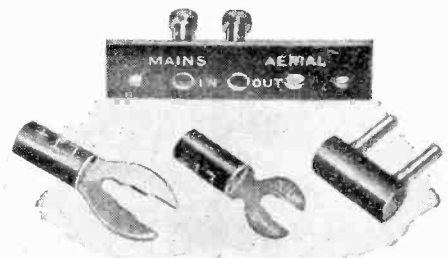

Some Clix insulated sockets and spade terminals.

Rotary transformers will be the feature of the Electro-Dynamic Construction Company's exhibit as usual, and the most recent addition is a small H.T. generator for use with motor car radio sets. Sound Sales have applied the converter unit idea to mains equipment, for this year they will have a small unit described as the Westkit Eliminator kit, which embodies a mains transformer, Westinghouse H.T. rectifier, and fuses ready wired for fitting in a receiver or eliminator. Home chargers will be featured also. Rotax, Ltd., who have for long specialised in the construction of small machines for obtaining H.T. from L.T. bat-

What to See at the Show.—

teries, house lighting plants, and D.C. supply mains have introduced a new M-L anode converter for car radio use.

Several changes have been made in the Westinghouse range of metal rectifiers. Models H.T.6 and H.T.7 are now replaced by one new model, the H.T.12, giving 200 volts at 30 mA. Another new rectifier is the

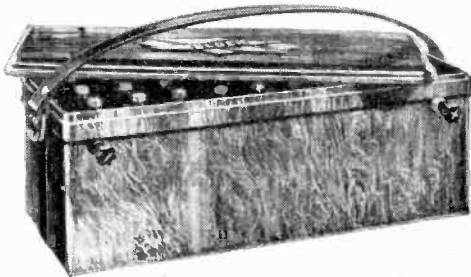

Block Batteries 60-volt H.T. accumulator.

style H.T.13, designed specially for use with Q.P.P. and Class "B" amplifiers, as it possesses particularly good regulation.

For sundry small components, such as insulated plugs and sockets, fuses and switches, a visit should be made to the stands of Belling-Lee, Bulgin, and Lector-Linx.



H.T. and L.T. Batteries.

The majority of battery makers have extended their respective ranges to include several new batteries for Class "B" and Q.P.P. receivers. These can cope with the momentary heavy discharges that occasionally occur without detriment to the life of the cells. In general, these models fall within the double or extra capacity class, and will be shown by Britannia Batteries (Pertrix), C.A.V., Drydex, Ever Ready, G.E.C., Grosvenor, Hellen, Oldham, Siemens, Smith's (Anodex) among others.

New style container housing Dubilier paper condensers.

Fuller (Sparta), High- and low-tension accumulators are to be featured by Block Batteries, who have developed a type of cell in which the usual lead grid is omitted, by C.A.V., Dagenite, Exide, Oldham, and Milnes Radio. The last named make incorporates nickel-cadmium plates immersed in an alkaline solution, and its special feature is that it can be charged from the L.T. battery. It is robust, and not damaged by heavy discharge.

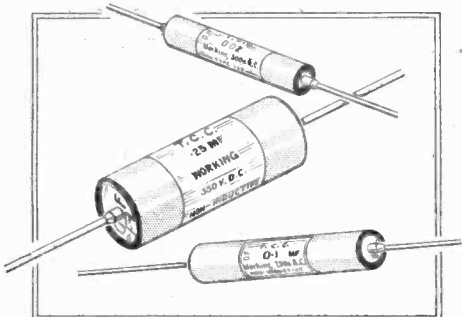

Selection of T.C.C. tubular condensers.

Fixed Condensers.

The Telegraph Condenser Company have extended their range of small tubular condensers to include values up to 0.25 mfd.



Telsen high voltage dry electrolytic condenser.

These are fitted with wire ends, and, being light and compact, can be suspended in the wiring most conveniently, thereby leaving the baseboard free for the more bulky components. A special display is to be made of the type 87 paper smoothing condenser, a model which is rated for 450 volts working, but will safely withstand surge voltages up to 650 D.C. Small tubular condensers are to be shown by British Radiophone and Telsen, the last mentioned having also a new range of high- and low-voltage dry electrolytic condensers.

The Dubilier type 9200 metal-cased condenser is replaced by an improved design assembled in a tubular container fitted with terminals and embodying a unique fixing device. Several modifications, also many additions to existing types to comply with present-day requirements, constitute the main features of the Dubilier programme. Ferranti, Sound Sales, and Igranich will also have many interesting specimens for inspection.

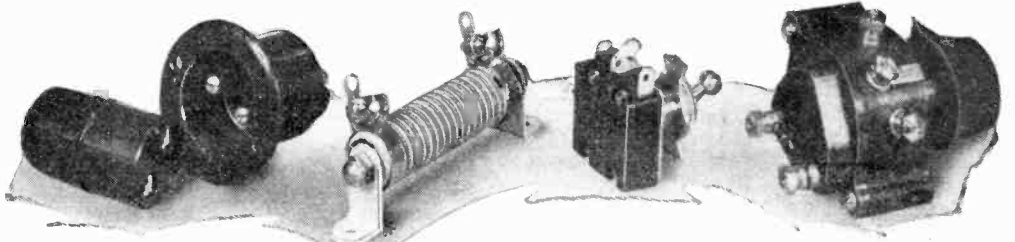

Selection of Bulgin components.

Miscellaneous Components and Accessories.

Among the many additions made to the range of electric clocks made by Ferranti will be one embodying an alarm mechanism which comes into action but once in each twenty-four hours. Many very attractive cabinet designs have been prepared by the Carrington Manufacturing Company, while further examples of wireless furniture for the new season's receivers will be found on the Osborn and C.A.C. stands.

The requirements of the radio service engineer are catered for this year by Standard Telephones and Cables, Ltd., who have developed a series of inexpensive units comprising a modulated oscillator, output meter and attenuators; the two first mentioned would suffice for completely overhauling a wireless receiver, and, combined by their

special carrying strap, forms a most useful and portable test set. The Radiolab Engineering Company have introduced a portable test set, and, of course, there will be the range of Avometers made by the Automatic Coil Winder and Electrical Equipment Company, who now have a further model described as the Avominor. This is an inexpensive version of the larger instruments, and has three milliamp ranges, three voltage scales, and provision for measuring resistances. Measuring instruments will be a feature also of the Ferranti exhibit.

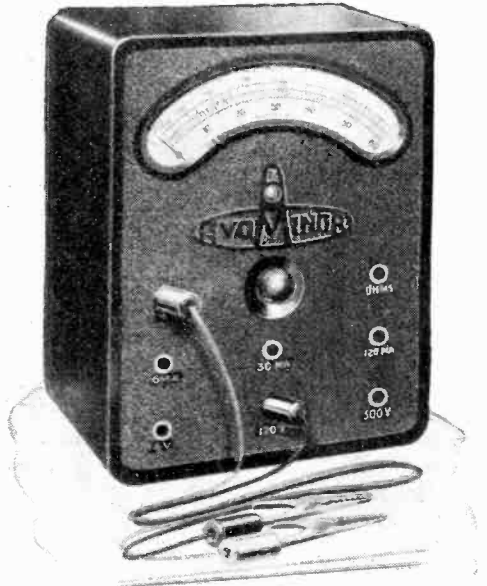

New multi-range Avominor.

Self-locking washers, tags, and sockets will be a feature of the Gripso exhibit, and an inexpensive microphone is to be shown, among other items, by R. C. & Wilson. R.I. have a new Parafeed transformer for auto-coupled circuits only, and Bulgin have developed a power version of their Trans-

coupler; known as the type B, it gives a one-to-four voltage step-up and embodies three-watt anode resistances.

VALVES

IN past years, the multiplicity of valve types available in this country has often excited astonishment. In spite of the fact that valve manufacturers have recently dropped many of their older models, and now carry stocks of 4-volt and 6-volt types only for replacement purposes, there are no signs of a reduction in the number of types on the market, rather of an increase. The current year has seen a steady outpouring of new valves, and as yet the flow is undiminished.

The introduction of the Class "B" output valve is probably the greatest step forward

What to See at the Show.—

from the point of view of the battery user, for it enables him for the first time to obtain both high quality and large volume economically. Practically every valve firm will be showing at least one type, and in spite of the fact that they fall into two general classes—those capable of giving about 1 watt output and those rated for some 2 watts—they show a surprising uniformity in their quiescent anode currents, which are usually between 2 mA. and 3mA. The output load required, however, varies considerably between different valves, and this point should be watched carefully when selecting a valve to work with existing apparatus. In most cases little or no grid bias is needed, but the Marconi-Osram B.21 type is unusual in that it requires a negative grid bias of 3 volts to 6 volts.

Class "B" working leads naturally to the driver valve, but here we are fortunate in finding that no new type of valve is indicated. The driver is merely a new name for a particular class of triode valves, and many well-known L.F. amplifiers have acquired a fresh dignity from their new title.

As might be expected, most of the new valves are in the A.C. mains range, although notable additions have been made to the D.C. types. Variable-mu valves are now practically universal for H.F. and I.F. amplification, whether the receiver be fitted with A.V.C. or not. One of the chief difficulties in obtaining good A.V.C., however, has lain in avoiding overloading of the H.F. or I.F. valves, for some A.V.C. systems call for a large signal input to the detector. The overload point of the tetrode valve is set largely by the negative resistance kink in its characteristic, and as this can be avoided by a pentode type construction, we shall find many examples of pentodes specially designed for H.F. amplification purposes, and provided with variable-mu characteristics.

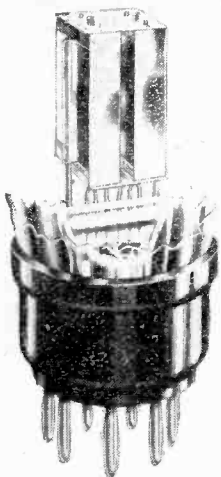

Cossor 240B Class "B" valve.

Variable-mu H.F. pentodes will be shown on the Cossor, Micromesh, Mullard, and Six-Sixty stands, while Ferranti will have a model fitted with a 5-pin base and rated for 100 volts screen potential. The Marconi-Osram type, however, is obtainable in two patterns—one with a 5-pin base and an internally connected suppressor grid, and the other with a 7-pin base with the additional grid brought out for external connection, thus extending the application of the valve.

These firms will also be showing the first battery variable-mu H.F. pentode.

H.F. pentodes with non-variable-mu characteristics will be shown by Cossor,

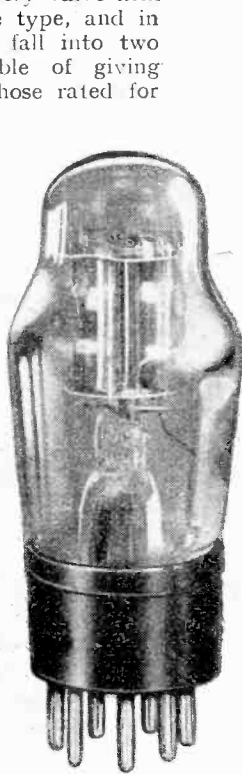

Marconi-Osram B.21 Class "B" valve.



Ferranti VHT4 Heptode frequency changer.



Six-Sixty 220B Class "B" valve.

Marconi-Osram, Mazda, Mullard, and Six-Sixty; their chief use seems to be as detector-oscillators for superheterodyne frequency changers, although they can also be used for H.F. amplification and ordinary detection. Ferranti will have the first British Pentagrid frequency-changer valve on view, the type VHT4 Heptode; it is fitted with a 7-pin base and the tetrode control grid is brought out to the top of the bulb. It consists essentially of a variable-mu tetrode in conjunction with a triode oscillator, the elements being screened from one another. It is not merely two valves built into one bulb however, for the tetrode portion has no cathode in the normal sense of the word, and mixing takes place by electronic action.

Detectors.

The range of detectors will be greatly increased, for in addition to the usual triodes, tetrodes, and pentodes there will be found a bewildering variety of combination diode types. The most usual is the duo-diode-triode, which is made by Ferranti, Marconi-Osram, Micromesh, Mullard, and Six-Sixty. Both Marconi-Osram and Mullard will have this valve also in D.C. mains form. The valve enables many new circuit arrangements to be employed, but its chief purpose is undoubtedly for providing rectification, amplification, and delayed A.V.C. A single-diode-tetrode will be shown by Mullard, and it is intended to replace the ordinary screen grid detector, for it has a greater input handling capacity. Cossor will have a duo-diode-pentode, consisting of a pair of diodes for providing rectification and delayed A.V.C., and a variable-mu pentode for the first L.F. stage and to which A.V.C. bias can be applied to give simple,

but practically perfect, automatic volume control. Metal rectifiers, in both single and double types, will be shown by Westinghouse, and these enable ordinary or push-pull detection and A.V.C. to be obtained.

In the output stage there will be fewer new types, but Ferranti have introduced a triode with an output of 2½ watts at 250 volts, and the Mullard ACo44 has been designed to have similar characteristics. In pentodes, the well-known Marconi-Osram MPT4 is now available in the Catkin type with its output increased to 3 watts, and there is also a new directly heated pentode with a 16 watts anode dissipation rating. Most indirectly heated pentodes will be available in two types—one with the usual 5-pin base and a side terminal and the other with the new 7-pin base. Although it is but a short time since this base was introduced, originally for the Class "B" valve, many valves will now be supplied with it, including the output pentodes, Class "B" valves, duo-diode-triodes, duo-diode-pentodes, H.F. pentodes, and the Pentagrid or Heptode.

H.T. rectifiers have not been forgotten by the valve designers and the indirectly heated rectifier, introduced some time ago by Mazda, is now to be found in other ranges. Thus, Marconi-Osram will have the MU.12 and MU.14 types, equivalent to their older U.12 and U.14 models. The advantage of indirect heating in a rectifier, of course, is the avoidance of sudden high voltage surges which are detrimental to the life of the smoothing condensers.

In the range of D.C. mains valves, few new types will be found. Mullard will have a range with heaters rated for 20 volts at 0.18 ampere, with the exception of the duo-diode-triode, which requires 25 volts. The Marconi-Osram range is extended by the addition of a duo-diode-triode, and this firm has also introduced a barretter type of voltage regulator for maintaining constant heater current in D.C. mains sets. Cossor will have D.C. valves of the 16 volts 0.25 ampere type, including a variable-mu tetrode, a triode, and an output pentode.

As is usual with D.C. mains valves, these specimens are all rated for a maximum anode potential of 200 volts.



Ferranti VPT4 screened H.F. pentode.

Extension Loud Speakers

Points to Consider When Adding a Second Speaker

By M. G. SCROGGIE, B.Sc., A.M.I.E.E.

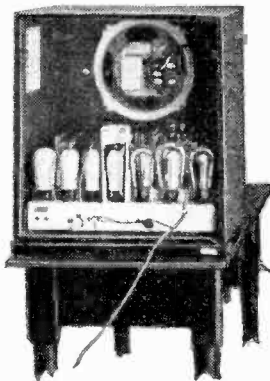

WHEN it is desired to connect a second loud speaker, possibly on extension leads, several points have to be given consideration. These are discussed in the following article and practical illustrations of various methods of connection are given.

SOME weeks ago it was suggested in *The Wireless World* that the custom of building the loud speaker into the set is far too prevalent. If the loud speaker is a separate unit, the receiver itself can be established in the most convenient and effective place, and taking the loud speaker to the listener is merely a matter of providing leads of sufficient length.

But things are not quite so simple when the set already has an internal speaker. Two matters must be considered—making the connection and keeping the impedances right. If it is a case of using some loud speaker that happens to be available, the problem is one of connecting it in the most efficient way. But if the speaker can be chosen specially for the job, it is generally possible to use the terminals or sockets that most manufacturers and some designers for constructors provide for the purpose.

Question of Impedance

Let us consider the impedance question first. For each output valve there is a certain loud speaker impedance that enables the greatest undistorted output to be obtained. Now, there is certain to be confusion if it is not realised that the impedance of a loud speaker may mean either of two things. When the speed of a ship is said to be 20 knots, it may mean the rated speed of the ship, which is a fixed part of the specification, or it may mean the actual speed, which varies from time to time according to the instructions given to the engine room. In much the same way the actual impedance of a loud speaker cannot strictly be stated by a single figure, because usually it depends quite a lot on the frequency at which it is measured. That is not very much help to us, because a valve cannot match a whole range of impedances simultaneously, so a sort of representative figure is chosen to be the rated impedance;

and, although the actual impedance, being different at most frequencies, causes them to be insufficiently reproduced, the rated figure is that which gives the best balance of tone.

Fortunately for the balance of tone it is possible for the actual impedance to depart considerably from the ideal before the efficiency falls off seriously. But while there is a good deal of latitude—more with triodes than with pentodes—the *rated* impedance should be kept reasonably close to the optimum for the valve.

Fig. 1.—(a) If the impedance of the external loud speaker is lower than that of the other, series connection is allowable, but the volume at the extension end will be lower. It is generally satisfactory if the two impedances are equal and the volume from each is then equal (but try parallel connection as an alternative). (b) If the impedance of the extension speaker is higher, it may be connected in parallel, but the volume will be lower. This is also an alternative connection in the case of similar loud speakers. (c) A low impedance speaker with a step-down transformer is equivalent to a high impedance, and the connection shown is one particular example of (b).

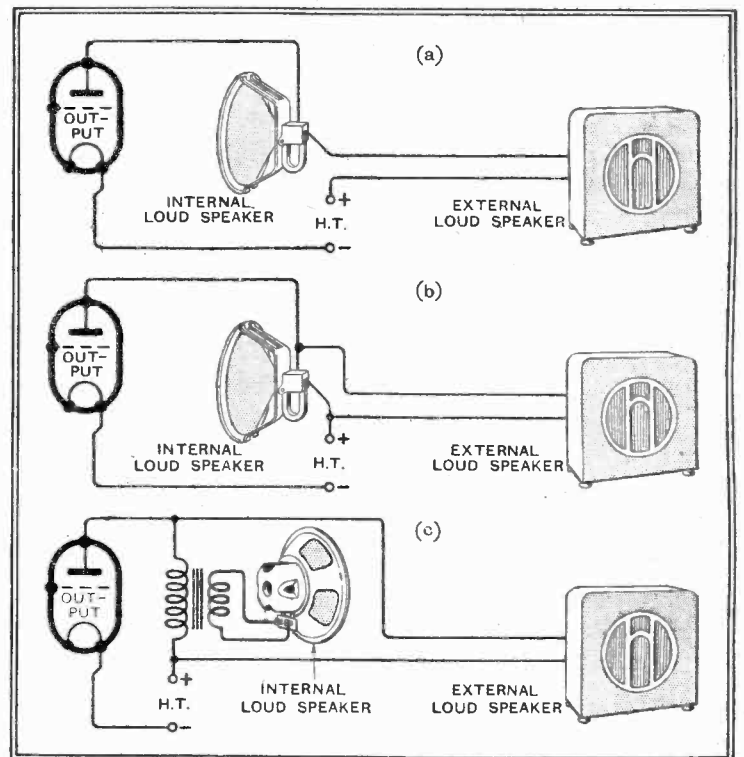

Suppose, for example, that at the lower frequencies the impedance of a certain speaker falls to half the rated amount. The resulting weakness of low notes may pass unnoticed. But if advantage is taken of this apparent tolerance by using a loud

speaker with a rated impedance half the optimum for the valve, then the actual impedance falls to a quarter at the low frequencies, and that can scarcely fail to be objectionable.

The point to be noted is that the amount of latitude that can be tolerated in matching a speaker to a valve depends on how much the actual impedance departs from the rating, and in any case the tolerance is less for a pentode than for a triode.

Practical Examples

Assume now that the impedance of the internal loud speaker (A) is correctly matched to the output valve. Obviously, if another (of impedance B) is connected either in series or parallel, the impedance

of the combination (C) is no longer perfectly correct. If B is considerably less than A, then it has relatively little effect when connected in series, and C is not far enough away from the ideal to matter. But, unfortunately, the total power

Extension Loud Speakers—

obtained from the valve is divided unequally, and B gets only a small share. If it is quite in order for the external speaker to give reduced volume, well and good; the method is sound. But a parallel connection wouldn't do at all, for C would be far too low, and not only would there be unequal distribution of output, but the output would be much reduced.

Next, suppose that B is considerably greater than A. Now the results are reversed; for series connection is hopeless, giving a poor output, unequally divided. Parallel connection upsets the matching to a negligible extent, and is therefore a possible scheme so long as the extension is not required to give so much volume as

used in most modern receivers, so this is the point at which to explain that up to the present the transformer has been considered as part of the loud speaker. The

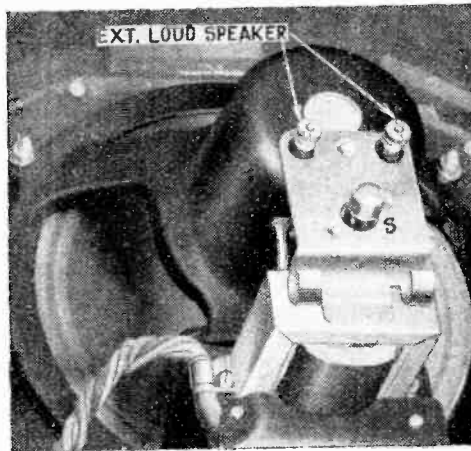
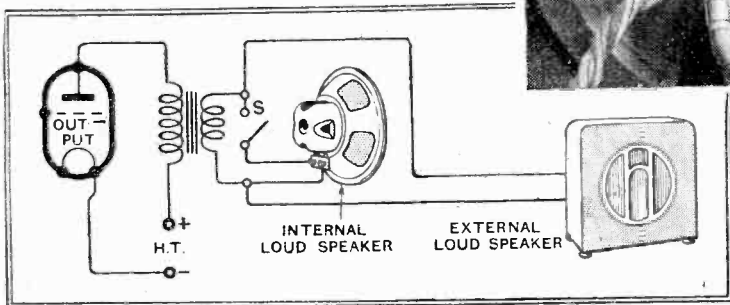

Fig. 2.—A method of connection commonly employed in sets of commercial design.



the built-in speaker. The less the extra speaker disturbs the matching the less volume it gives.

But perhaps the most likely situation is that in which A and B are equal, or nearly so. Then series connection doubles the impedance, and parallel connection halves it, and in both cases the power is equally divided. In the most favourable circumstances even this rather wide departure from ideal matching is not really noticeable. However, it is probable that the matching was not quite the best in the first place, and by choosing the appropriate method of connection the combination may be just on the other side of the optimum, and therefore about as good as before. So far as tone is concerned, the least disturbance is caused by a series connection in the case of the triode; but the pentode is complicated by tone correctors, and actual trial is the soundest plan.

Compromise

Really conscientious readers will no doubt feel uncomfortable about a 100 per cent. departure from the theoretically correct, even if the resulting imperfection cannot be detected by the non-technical members of the family. They have the option of changing the output valve to match the combination of loud speakers (which may be a fairly simple business in a battery-driven set, but introduces awkward problems of bias, grid swing, and H.T. supply in a mains set), or using two loud speakers, each half or double the impedance of the original one, or introducing a 1:1.4 transformer for connecting two equal loud speakers in series, or a 1.4:1 transformer for parallel connection, or, lastly, if there was originally a transformer, altering the ratio to give the same effect. An output transformer of some sort is

effect of the transformer is to multiply the impedance of the loud speaker alone by the square of the step-down ratio. For example, a speaker with a 10-ohm coil, connected by a 20:1 step-down transformer, behaves as a 10×20^2 , or 4,000-ohm loud speaker. A step-up may be regarded as a fractional step-down, so an 8,000-ohm speaker coupled by a 1:2 transformer is equivalent to a $8,000 \times (\frac{1}{2})^2$, or 2,000-ohm speaker.

Thinking along these lines, it is clear that if a 4,000-ohm speaker is connected in parallel with a 20:1 transformer feeding a 10-ohm speaker, the result is equivalent to two 4,000-ohm speakers in parallel, or 2,000 ohms altogether. An untapped output choke is, of course, equivalent to a 1:1 transformer, and a tapped choke to a

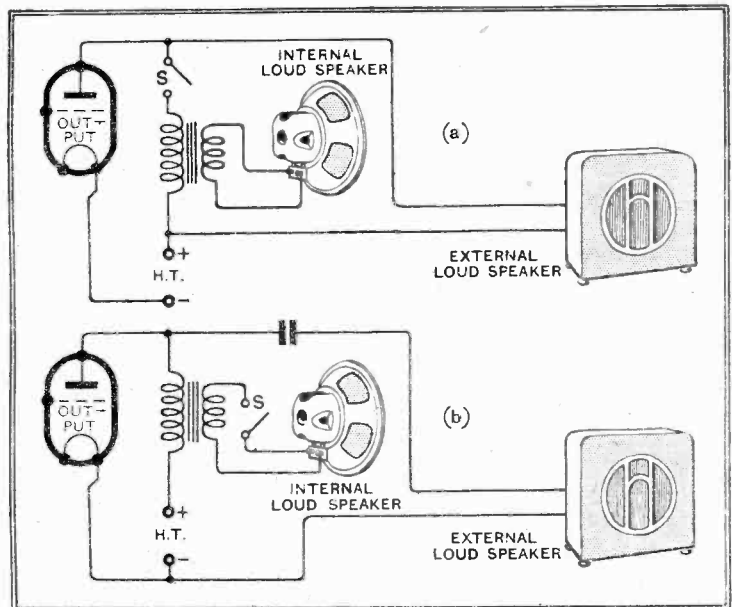

Fig. 3.—Two other methods employed commercially. (a) has the objection that the extension lead is live. In (b) this is avoided.

transformer with the same turns ratio. And in matching push-pull stages it must be remembered that the two valves are in series, so the optimum load is double that for one valve connected across the whole primary.

Class B stages are usually rated as one valve, anode to anode.

If the extension is in place of the internal loud speaker, and not in addition to it, obviously the matching difficulty does not arise, for a speaker of the same impedance is correct. On the other hand, it may be necessary to feed more than one extra speaker; the same principles cover the case.

Examples of Practice

So much for theory. Now we shall look at the most usual output connection systems to see where an extension can be tapped on. A very common arrangement in manufactured sets is that of Fig. 2, used, among others, by Marconiphone, H.M.V., Columbia, Philips, Pye, Bush and R.G.D. The external loud speaker terminals or sockets are paralleled across the coil of the internal loud speaker itself. The impedance at this point is usually low, from 10 ohms downwards; so it is no good using a high impedance speaker. One of the same type, without a transformer, or one of slightly greater impedance, must be used. Of course, it is possible to step up again to a high impedance speaker and get the same effect, but each transformer introduces additional loss, and this can only be regarded as a make-shift. A few receivers are provided with a switch at the point S, and it is generally a simple matter to fit one if it is absent. The contacts should be good, as the total resistance of the circuit is sometimes very low.

Most other sets that include an outlet for extra loud speakers do so after type (a) or (b) in Fig. 3, which amount to the same thing, so far as impedance is concerned; but while (a) makes the connections live, and is contrary to I.E.E. regulations, (b) brings them to earth, and is

safe. It is, of course, simple enough to convert (a) to (b) by the addition of a condenser (commonly 2 mfd.), but the choice of value is discussed fully by Dr. L. G. A. Sims (see p. 677, June 29th, 1932 issue).

In either case it is a high-impedance connection, requiring either a high-imped-

Extension Loud Speakers—

ance speaker or a step-down transformer. As regards switching out the internal speaker, (a) and (b) are not equivalent. In (a) it is an advantage to break the primary circuit at S, assuming that the extra loud speaker or its transformer can carry the full valve current. In (a) it is possible, and in (b) it is essential, to break the secondary, leaving the primary

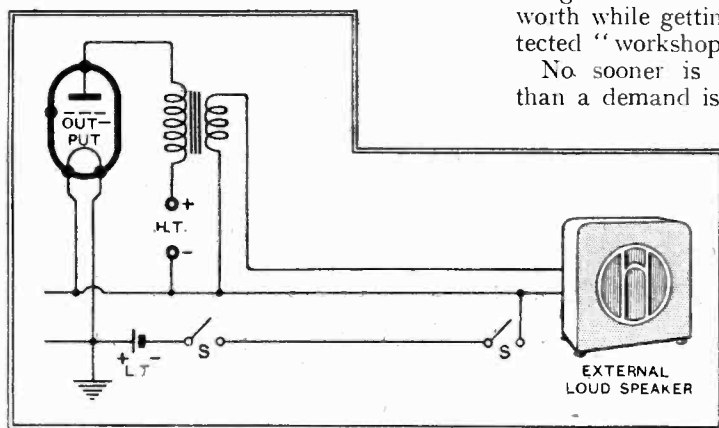

Fig. 4.—An arrangement suitable for battery sets.

to function in the capacity of an output choke.

The most suitable wire to use for the leads themselves depends on whether Fig. 2 or Fig. 3 system is to be used. It must be remembered that the impedance of the extension circuit of Fig. 2 may be very low—an ohm, or even less—and the resistance of the extension leads should be much lower still, which may mean quite a heavy gauge for a long run. But as the circuit can, and should, from every point of view, be earthed, and the voltage is very low, insulation need not be on an expensive scale.

Just the opposite requirements apply to Fig. 3; any wire sufficiently strong mechanically is more than adequate for the current, but the full signal voltage—and in 3 (a) the H.T. voltage also—is imposed, and well-insulated wire of the

type used for 250-volt house lighting is the right stuff. And don't forget that there is an infrequent but, nevertheless, distressing incidence of accident as the result of 250-volt shocks, so the insulation should include any terminals at the far end of the line. For the same reason it is preferable to make a permanent job of it, with plug connections, rather than trailing flex. If it must be flex, for anything other than occasional use, it is worth while getting some of the well-protected "workshop" variety.

No sooner is the extension installed than a demand is certain to arise for remote control to avoid the fatigue of walking into the other room. There are all sorts of remote control systems, from simple ones in which a switch on and off is the extent of the control, to elaborate and costly schemes that include tuning and

volume control. A.V.C. has largely cut out the tedious task of trying to make a receiver in another room give constant volume on a fading station. Those who are interested in the endless possibilities of remote control can refer to back numbers of *The Wireless World* or the various proprietary systems marketed.

One can, in a more or less complicated manner, work an on-off control over the twin loud speaker extension leads, but it is very much easier to do it with a triple lead (if the still more satisfactory pair of twin leads is deemed extravagant). Fig. 4 shows a simple triple lead system for a battery set. The same can be adapted to mains drive, but, unless carefully carried out, is definitely undesirable, because one line is common to mains and loud speaker. Two separate pairs are recommended.

RADIO SERVICE TEST SETS

Self-contained Portable Equipment for the Service Engineer

MUCH can be done in locating faults with a few well-chosen instruments, but the service engineer of to-day is required to check the ganging of the tuned circuits throughout the broadcast wave-range, test for, and if necessary correct, misalignment of pre-selector and oscillator circuits in superheterodynes, check the function of I.F. amplifiers, and also make such adjustments as are necessary to ensure adequate selectivity and sensitivity having regard to the requirements of the user.

In order that work of this nature may be carried out expeditiously Standard Telephones & Cables, Ltd., Connaught House, Aldwych, London, W.C.2, have introduced an inexpensive radio set testing equipment. It is constructed in unit form, each unit being self-contained so that additions can be made from time to time and eventually a complete equipment for making all tests and measurements on a wireless receiver,

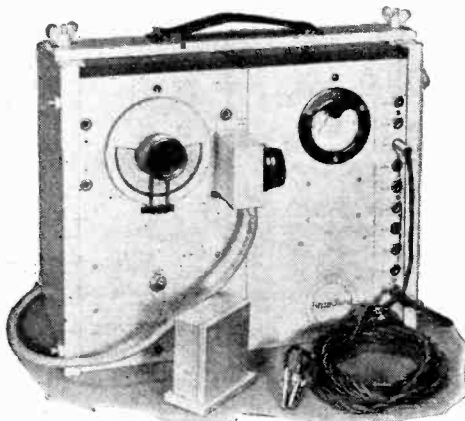

Standard Telephones portable Radio Service Test set, comprising type 401A Modulated Oscillator and type 402A Output Meter.

FOREIGN BROADCAST GUIDE

MONTE CENERI

(Switzerland).

Geographical position: 46° 9' N.; 8° 55' E.

Approximate air line from London: 550 miles.

Wavelength: 1,154 m. Frequency, 260 kc/s. Power: 20 kW.

Standard time: Central European (coincides with B.S.T.).

Standard Daily Transmissions.

16.00-18.00 B.S.T., Concert (Sundays only); 20.29, weather, musical concert or gramophone records; 21.00, talk, main evening entertainment; 22.10, news; 22.30, dance music or records

Announcer: Woman.

Language used: Italian.

Call: *Radio Svizzera Italiana*.

Opening signal: One stroke on a gong.

Interval signal: Church chimes (gramophone record).

including overall response curves, sensitivity and fidelity measurements, can be compiled.

The nucleus of the apparatus is the type 401A Modulated Oscillator which is an H.F. generator modulated by a 400 c/s note, both sets of oscillations being generated by a single screen grid valve. The batteries are self-contained and of the dry type, and about 50 working hours is the estimated life of the L.T. cells.

Three sets of coils would be required normally to cover the broadcast wave bands and the superheterodyne I.F. frequencies, but by utilising harmonics of the lower frequencies (long waves) one coil is made to cover ranges of approximately 1,450 kc/s, (207 metres) to 500 kc/s (600 metres) and 290 kc/s (1,070 metres) to 100 kc/s (3,000 metres).

On the medium waveband the fifth harmonics of the long waves are used for the purpose of calibration.

This unit suffices for a large number of tests, the performance of the set being judged aurally. Over the major part of the medium-wave band strong third harmonics are encountered, but as most modern receivers are calibrated either in wavelengths or in stations no difficulty will arise in picking out the correct one. A fourth harmonic is present, but far too weak to be audible on any but the most sensitive sets, and is of little consequence. Incidentally, a plug-in coil, covering the 1,500 to 600 kc/s band is available if required, to replace the standard coil, but then the calibration will be approximate only.

This unit includes an H.F. attenuator, but it is not calibrated.

Since greater precision than that afforded by aural tests can be obtained by using an output meter, a complimentary unit described as the No. 402A Audio Frequency Output Meter is available. It replaces the loud speaker and combines an artificial load and a metal rectifier-type voltmeter calibrated in decibels with a range of -9 dB. to +9 dB. referred to an output of 50 milliwatts. Tappings for matching receiver output circuits of from 20 to 20,000 ohms impedance are provided.

These two units, together, form a complete testing set eminently suitable for servicing purposes, and when combined by means of the special carrying handle made for this purpose becomes readily portable.

The 401A Modulated Oscillator costs £5 18s. and the 402A Output Meter £2 16s. Additional units are in course of preparation and a calibrated H.F. attenuator will be available shortly.

News of the Week

Current Events in Brief Review

If Winter Comes . . . at Olympia

ALL types of weather are being provided for by the organisers of the Olympia Radio Show. A cooling plant has been installed to operate in case of a heat wave, while, to cope with dull and chilly weather, large ultra-violet lamps have been fitted to give visitors the sensation of summer on the Riviera. If normal weather prevails it is possible that both appliances may be used.

Last year, when the usual temperature in London was in the region of 99°, Olympia was recognised as the coolest spot in London.

New British Broadcasting Station?

A GARDEN party was held at the Independent College, Whalley Range, on Saturday, July 29th, on behalf of a fund to set up a special Scripture wireless station which every day would broadcast sections of the Bible.

Wireless Again

SIX deep-sea trawlers fitted with Marconi wireless apparatus assisted General Balbo and the Italian flying squadron on the flight from Italy to Chicago. The General, in his first report to Signor Mussolini, has emphasised the value of the help which wireless gave during the most difficult section of the flight over the Atlantic.

Classes in the Clouds

A FLYING radio classroom is a recent innovation at the R.A.F. wireless centre, Cranwell. We learn that a "Victoria" troop carrier has been equipped with a number of transmitters and receivers so that each pupil on board has a self-contained installation, with its own aerial, for the purpose of receiving instruction under the actual service conditions.

The new system speeds up training and avoids waste of time arising from the minor troubles and misunderstandings which occur when no instructor is present.

Mr. Caldwell's Flutter

ONE of the most prolific factories for radio ideas in America is the brain of Mr. O. H. Caldwell, formerly Federal Radio Commissioner. A volume could be filled with the various gadgets and novelties which Mr. Caldwell has invented. His latest is an attachment to radio receiving sets whereby "an electric light or bell or chimes would automatically call the attention of listeners to an extraordinary programme that has not been previously scheduled."

Mr. Caldwell points out that this could be operated quite easily by means of a "flutter" or special signal transmitted from the broadcasting station. The listener would then know when the latest transatlantic fliers were about to arrive and "say their mouthful" at the microphone.

"The Wireless World" Index and Binding Cases

THE index for Volume XXXII, January to June, 1933, is now ready, and may be obtained from the publishers at Dorset House, Stamford Street, London, S.E.1, price 4d. post free, or with binding case, 3s. 1d. post free.

Britain's Youngest

THE claim of Mr. R. D. L. Dutton (G6QQ), of Oxford, to be the youngest amateur transmitter is challenged by King Edward's School, Stourbridge. We are informed by Major J. Timbrell that G6OI and G6OJ, the school's transmitting stations, are handled by a fully licensed operator, Mr. F. C. Hambrey, who is only fourteen years of age.

During the past six years over fifty operators of these stations have been fully licensed, their average age being sixteen.

The Bisamberg Mystery

IT has already been remarked that the strength of the new Austrian 150 kW. station at Bisamberg has not come up to ex-

"Radio Progress Week"

A GREAT "wireless week" is to be held in the U.S. during October next. It will be sponsored by the manufacturers, who evidently feel it to be a reproach that only sixty million American homes are equipped with radio.

Irish Radio Show

THE Wireless and Gramophone Exhibition of the Irish Free State is to be held as usual in the Mansion House, Dublin, under the auspices of the Irish Radio Traders' Association, Ltd., from Monday, September 18th, to Saturday, September 23rd, inclusive.

The Show is expected to attract more attention than previously on account of the recent opening of the high power station at Athlone.

5-metre Tests from Snowdon

FROM 12.20 p.m. to-morrow until 6 p.m. (B.S.T.) ultra-short wave test signals will be transmitted from the summit of Mount Snowdon by G5BY and G6UH. The test, which was more fully described in last week's issue, will constitute an effort to

contacts are taking place) will be as follows: Transmission, 0-10, 20-30, and 40-50 during each hour. Reception, during the times between these periods.

Reports should be sent to Mr. H. L. O'Heffernan, 3, Chepstow Road, Croydon.

Italy's "Wireless Week"

THE recent "wireless week" in Italy proved a great success, partly because every purchaser of a new radio receiver during the "week" was furnished with a free licence for one year. It is estimated that 80,000 new listeners have been enrolled.

"Radio City" without Radios

AN eagle-eyed reporter has discovered that the Radio Corporation of America, the first to advocate "a radio in every office," has neglected to provide for radio equipment in its own offices or in any of the offices of the R.C.A. building in "Radio City." A recent inspection showed that the new building has neither special electrical plugs for receiving sets nor centralised antennae for multiple use.

Dismissed

WHOLESALE dismissals among the staff of the Reichs Rundfunk Gesellschaft have occurred in the last ten days. According to a communiqué issued by the German Ministry of Propaganda, a number of leading broadcasting officials were "instantly dismissed" on July 31st with three months' salary. The reasons given are "proven inability and political unreliability." Among the prominent figures which depart under the new regime are Dr. Magnus, former Director of the Reichs Rundfunk Gesellschaft; Dr. Flesch, former Director of the Berlin Funkstunde, and Herr Alfred Braun. The Savings Commissioner informs the public that these dismissals will save listeners one million marks.

Actually 100 of the old staff of the Berlin "Broadcasting House" were dismissed on the same day.

Catching the Transmitter

OVER 80 per cent. of the competitors discovered the hidden station in the course of the 7th Annual Direction Finding Competition of the Golders Green and Hendon Radio Society, organised by Lt.-Col. H. Ashley Scarlett, D.S.O.

The campaign ranged over the district bounded by Berkhamsted, St. Albans, Watford, and Amersham—a "difficult" country which taxed the resourcefulness of the competitors. The transmitting station, which employed a wavelength of 164 metres, was under the control of Mr. D. N. Corfield (G6CT).

The results showed a great improvement over previous years, and the average error of the first two groups was only 0.8 per cent.

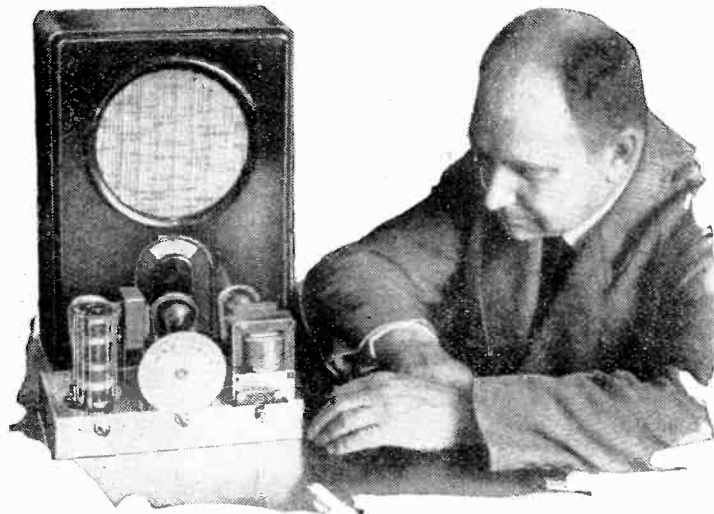

MAINS SET FOR £3 16s. od. Professor Leithauser, designer of the German "People's Receiver," with the A.C. model of his creation. The set has been produced by the combined efforts of twenty-eight firms to comply with the demand of Herr Hitler for a cheap receiver which would place the masses in touch with the official propaganda broadcasts.

pectations. We now learn that open complaints are being made by listeners in the surrounding district, who contend that the new transmitter fails to give better signal strength than the original station at Rosenhügel. As an indication that this is no trick of the imagination, it is worth mentioning that the Rosenhügel station still operates in the mornings, so that listeners can make almost direct comparison between the two transmitters.

A Vienna correspondent states that the trouble is probably due to the intervention of the Carpathian mountains, but we doubt whether this explanation would satisfy aggrieved listeners!

secure a world's record for ground-to-ground communication on 5 metres.

Owners of ultra-short wave receivers should have an excellent opportunity to pick up signals over a very wide range, and the experimenters, who are offering special souvenir awards for the best reports, hope to establish communication with such distant points as the Galloway Hills, Scotland (140 miles distant); the Wicklow Hills, Irish Free State (100 miles); the Isle of Man, the Cumberland Fells, the Wrekin, and the hills of Lancashire and Yorkshire.

Transmitting and receiving periods (except when two-way

Practical HINTS and TIPS

NO form of A.V.C. works really satisfactorily in conjunction with a manually operated pre-detection control. A little thought will show that this is bound to be so; if the sensitivity of the receiver is adjusted to a low level it is clearly impossible for the automatic control to counter the effect of severe fading.

Manual and Automatic Controls

Although manual control is essential for a set without A.V.C., it is not entirely necessary when this refinement is fitted. Provided that the A.V.C. system works really well, and is properly adjusted, the output valve will never have to handle signals sufficiently strong to overload it, and so a manual control will only be needed when reproduction at an abnormally low level is desired.

Although this can admittedly be done by means of an "H.F." sensitivity control, experience shows that with A.V.C. there is a tendency to forget this control and to leave it in a position corresponding to low sensitivity; further, the inclusion of such a control may upset the operation of the automatic system.

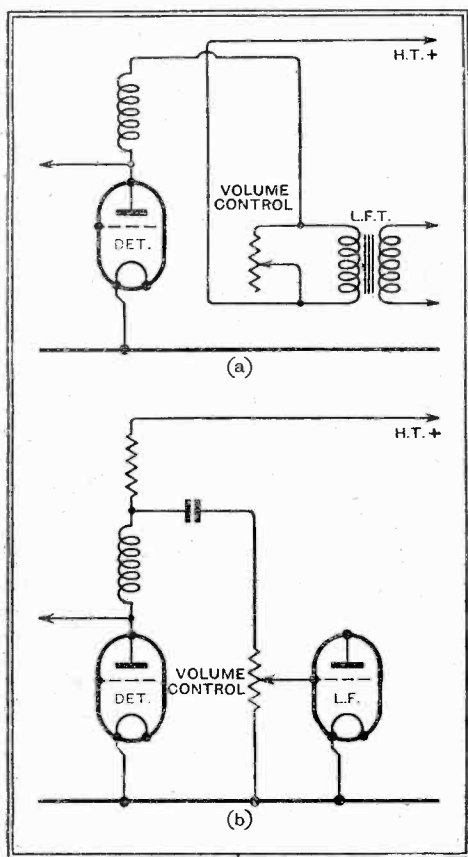

Fig. 1.—The simplest post-detection volume controls for transformer and resistance couplings.

It will therefore be obvious that a post-detection control, which will be quite independent of the automatic system, is distinctly preferable. Although it is not

AIDS TO BETTER RECEPTION

always easy to add this to an existing set in a manner that is entirely free from technical objections, the connection of a variable resistance of between 50,000 and 100,000 ohms maximum across the primary of the L.F. transformer will often prove entirely satisfactory. This arrangement has been criticised, but it often offers the advantage, at low volume settings, of introducing relatively greater attenuation of the middle register than of the upper and lower frequencies.

Where resistance coupling is employed a post-detection volume control, free of all possible objections, is more easily arranged; merely by replacing the existing fixed grid leak by a potentiometer of the same value, and connecting the grid of the succeeding L.F. valve to the slider terminal. These two methods of control are shown diagrammatically in Fig. 1 (a) and (b).

Over-run Resistances

ALTHOUGH the practice is not entirely defensible we often succumb to the temptation to pass through a fixed resistance a rather higher current than is intended by the makers. Modern resistances, both of the composition and wire-wound type, may often be treated in this way with impunity, although certain precautions should be taken to minimise the risk of trouble. In the first place, it should be realised that as a result of over-running the resistance a good deal of heat will be generated, and the component should therefore be mounted in such a way that no damage to other parts of the set can result. It is also advisable to provide for free radiation of heat; the amount of electrical energy that can be dissipated in a given resistance is greatly increased when the heat generated is quickly conducted away from it.

WHEN connecting a receiver to the mains certain precautions should be observed in order that the risk of accidental short-circuits may be minimised. Regarding this subject, a recently published sketch in the "Hints and Tips" section

Complying with Regulations

may have given a false impression, although it was intended to illustrate an entirely different matter. So far as mains connections are concerned, there is little risk of trouble if matters are so arranged that the projecting plugs of all plug-and-socket devices automatically become "dead" when they are removed from their sockets.

This point is illustrated in the accom-

panying sketch; arrangement (a) is contrary to regulations, for the obvious reason that, on withdrawing the two-pin plug from the receiver, a short-circuit might readily be introduced across the pins if the adaptor were inserted in a "live" lamp socket.

This disability is overcome by employing a special type of connector with recessed sockets, as shown in sketch (b).

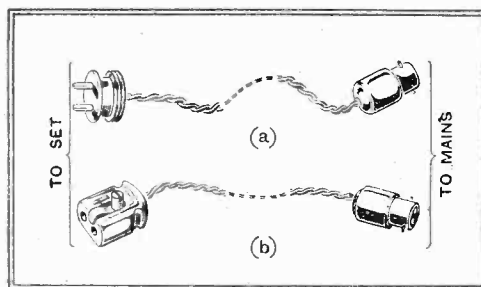

Right and wrong; projecting plugs connected as in sketch (a) increase the risk of short-circuits and are contrary to regulations.

The complementary part of this connecting device consists, of course, of a pair of projecting pins, which are mounted on the receiver itself.

IT is common practice to use the aluminium covering of a metal-covered plywood baseboard as an earth "return," and, in consequence, a number of electrical connections are made to it, either with wood screws or with bolts passing through both metal and wood.

Metal-covered Plywood

For some reason that is not quite clear the electrical quality of such connections seems to deteriorate in the course of time. Possibly the wood shrinks, or else it expands and contracts in turn; in any case the connections tend to become loose, and it is worth while to cultivate the habit of tightening them occasionally.

WHEN a receiver is deficient in bass response it is always worth while to explore the possibilities of artificially over-accentuating the lower notes—or under-accentuating the treble, which comes to very much the same thing—by deliberately applying more reaction than is necessary from the point of view of signal strength. In order that this may be done successfully it is, of course, necessary that the set should be fitted with a good input volume control, with a wide range of action.

Reaction as Tone Control

The idea does not always work, but the reproduction of music occasionally becomes definitely more pleasing as a result of adopting it.

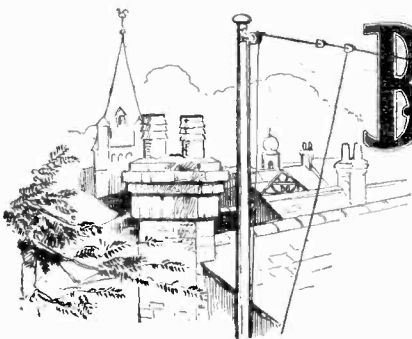

Broadcast Brevities

By Our Special Correspondent



Don't Clap Too Loudly

ONE cannot but admire the transparent honesty of the B.B.C. engineers. Although there has been no great popular applause over their success in synchronising the London and West Nationals (the achievement is too technical to win cheers from the gallery), there has been a steady flow of intelligent congratulation. But this well-merited praise does not deter the engineers from raising a hand in gentle protest and suggesting that the applause is premature.

Wait Till the Winter

Mr. Ashbridge says, in effect: "This is summertime and we expected success. Wait until the winter comes, when the maximum reflection of indirect rays occurs. Then see whether the two stations are happily matched."

This is a courageous attitude, and is one more proof that the B.B.C. engineering department is not out for the cheap applause of the moment.

Activity at Droitwich

RAPID progress is being made in the construction of the high-power station at Droitwich, and the B.B.C. is now promising that we shall hear the first transmissions by the summer of 1934 on 1,500 metres. These first high-power transmissions will sound a death knell to the National transmitters in England, but what is England's loss is Scotland's gain.

Good for the North Country

When Droitwich "takes over," little time will be lost constructing the new B.B.C. station in the Inverness district, which will most probably take the wavelength of 267.4 metres. Then will follow the new high-power transmitter for Newcastle.

Engineers are already exploring for a site north-west of Inverness.

Midland Regional to Follow

Midland Regional transmissions will continue from Daventry for some months after the long-wave programmes are transferred to Droitwich, and it will probably be Christmas, 1934, before Daventry is left solely with the Empire short-wave transmissions.

The Silly Season

IN recent years wireless seems to have had the honour of opening the "silly season," which has its run from the beginning of August till well into September. This year has been no exception; indeed, I doubt whether we have ever had a richer crop of baseless rumours than within the last ten days.

All This and More

We have heard that the B.B.C. will relay Sunday cabaret music from the Continent,

that the new woman announcer gets £500 a year, that the B.B.C. has begun stopping bad items half-way through with the excuse of a "technical hitch," that the B.B.C. engineers are roaming the country in search of "blind spots," that a rival B.B.C. starts before Christmas, that Sir John Reith . . . but why go on?

This is True

Let me tell you something that is true. It is that Sir Walford Davies is completely restored in health and will thus be able to return to the microphone in the evenings next autumn with a series of "Keyboard Talks."

The Compelling Touch

No broadcaster has succeeded to a greater degree than Sir Walford in combining the cultural with the entertainment side in microphone work. His "Music and the Ordinary Listener" was a weekly feast for musicians and non-musicians alike. I have often been amused at the spectacle of a hard-headed, single-minded technical man pausing in his experiments to listen to Sir Walford Davies expounding the beauties of the common chord or the delights of the dominant seventh.

No one else, one felt, could have "put it across" in the same persuasive way. We can undoubtedly look forward to many fascinating half-hours during the coming season.

Radio Plays on the Stage

IN Hungary they take radio drama so seriously that the theatres watch the broadcast programmes for suitable material. I now hear that immediately after the production by the Hungarian Broadcasting

Ambrose on Saturdays

LOVERS of "Ambrosial" music will have welcomed the announcement that Ambrose and his Orchestra are to continue their regular broadcasts on Saturday nights.

Beginning on Saturday, September 30th, this ever-popular dance leader will bring his band to a B.B.C. studio for a programme lasting from 10.30 p.m. to midnight.

When Restaurants Nauseate

Personally, I consider that dance music definitely gains by being broadcast from the studio, free from the extraneous noises which are inevitable in the best conducted clubs and restaurants. I have never been enchanted by the scuffle of human feet, while I am positively nauseated when the clash of knives and forks mingles with the passionate avowals of the crooner.

Savoy Bands at Portland Place

It looks as if we shall have more and more studio dance music this winter, for I learn that the Savoy bands may also perform at Broadcasting House in the near future.

The B.B.C. Declines

IS it fear of a tragedy that has persuaded the B.B.C. not to relay Mr. John Trantum's wireless talk during his forthcoming five-mile parachute jump on Salisbury Plain?

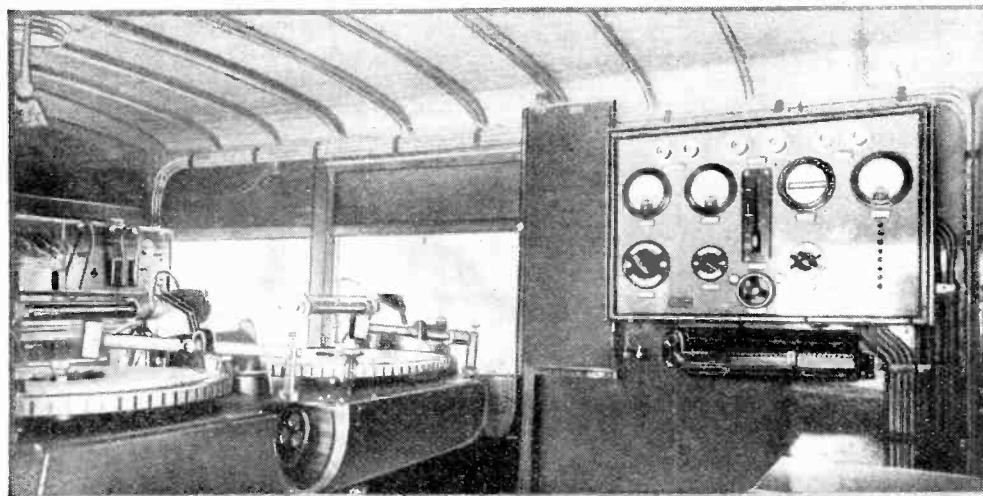

BROADCAST REPORTING. Inside the new "O.B." van of the German broadcasting service. A running commentary is given just as in the case of an ordinary outside broadcast, but the sounds are stored up on records for use several hours later.

Company of a new musical play, "Waltz and Love," which was transmitted from Budapest, the "Kiraly Szinhaz" theatre asked the two authors, M. Julius Halasz and M. Charles Kristof, to transform it into an operetta for the stage. This they are doing, and the play will be produced shortly.

At all events, the O.B. Department have decided definitely not to attempt it, although the world's champion parachutist will carry a short-wave transmitter from which he will speak for the two minutes during which he is falling before opening his parachute.

Correspondence

The Editor does not hold himself responsible for the opinions of his correspondents.

Correspondence should be addressed to the Editor, "The Wireless World," Dorset House, Stamford Street, S.E.1, and must be accompanied by the writer's name and address.

Wireless Propaganda

AS a reader of *The Wireless World* for a considerable number of years, I have always been impressed by the fairness of your "Editorial Comments." In the issue of July 28 you refer to "Wireless Propaganda," and I find myself in agreement with all that you say with regard to this, but when you pass on to a consideration of relay services I feel that you have only stated one side of the case.

You criticise the regulations of the Postmaster-General which allow relay services to pick and choose whatever items are desired both from the B.B.C. programmes and programmes from abroad. You will, of course, realise that a relay service depends for its very existence upon the goodwill of its subscribers, and it is therefore essential that a relay service shall choose whatever programme is most popular with its subscribers.

I am sure that *The Wireless World* would be the first in the field to oppose any move on the part of the Postmaster-General to restrict the use of ordinary wireless receivers to reception of British stations only. As a relay subscriber is compelled to take out a licence, which, after all, is a licence for wireless reception, and not for reception of B.B.C. programmes alone, it seems only fair that his choice of programmes should not be more limited than that of the ordinary wireless listener. In general, relay services only give foreign programmes at times when the B.B.C. transmitters are closed down and because of the fact that the receiving

station is usually situated in a country district they are able to give very excellent results.

Under the terms of its licence a relay service is not allowed to receive any foreign station which is giving anything in the nature of "propaganda," but I cannot see any reason why it should be prevented from giving a reasonable amount of foreign-sponsored programmes, especially when, as I believe, the B.B.C. is itself allowed to use a sponsored programme so long as it does not take any remuneration from the provider of that programme.

Burnley.

J. MUSCUTT.

Scratch Filters

A FEW months ago you published an article on scratch filters sent up by one of your readers. In this article he invited

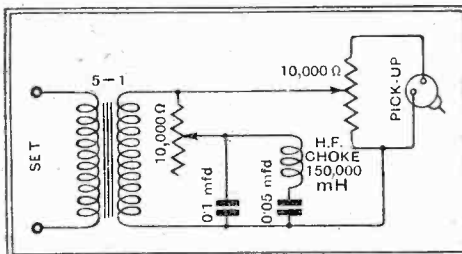

Details of the filter suggested by our correspondent.

readers to send up their experience with these filters. I have been fortunate enough to hit upon an almost ideal filter, which

eliminates most of the surface noise, without affecting string tone and other high notes, as my previous attempts have always done. It is really quite simple. Of course, values will have to be altered from those given in the diagram to suit different pick-ups. Mine is the Burndept N.A. pick-up fed into the amplifier through a 5-1 step-up transformer. In conclusion, I would state that I use an R.K. Senior loud speaker which is very sensitive to high notes and scratch.

R. F. S. GOEBEL.

London, N.16.

Relay Services—Should They Pick and Choose?

IN the Editorial of *The Wireless World* of July 28th you suggest that wireless relay services should not be allowed to pick and choose their own programmes.

The arguments you put forward in support of this plan are certainly not very convincing.

A user of a first-class wireless receiver such as *The Wireless World* Monodial can pick up any European station with the same ease as the operator of a relay service. As the percentage of the total listeners throughout the country who get their broadcasting through a relay service must of necessity always be a very small part of the whole, any restrictions on these services cannot be at all effective in preventing the public from hearing undesirable Continental transmissions. In other words, you are trying to mend a leak in the reservoir by mopping up the water that leaks out instead of stopping up the hole.

What good can possibly come of making further petty restrictions on the operators of relay services? We have already far too many such restrictions, and personally I would like to see some of them removed rather than have more added on.

Take our case. We run a dual programme service. We are several hundred miles farther from the Continent than are you in London. Continental reception in daylight is impossible. Since the B.B.C. started their "economy" system of giving no attractive programme until 8.0 p.m. we have had to turn to Athlone for our second service. If you have ever listened to that station between 6.0 and 8.0 p.m. you will know just how poor an alternative service it can be.

Now, sir, I ask you in all reason can you see any sense in a regulation which prevents us relaying gramophone records during this space? Could this possibly affect His Majesty's most worthy Postmaster-General, the B.B.C. or the wireless trader? I submit it could not. Incidentally, it would enable us to avoid relaying a poor programme from a country which is entirely anti-British in outlook and politics, and so in actual fact help to bring about the state of affairs most properly advocated by you.

Perhaps you are not aware that a restriction already exists to restrain relay services from relaying anti-British propaganda in English broadcast from any of the Continental stations.

ON WITH THE RELAY.

A Recent "Wireless World" Set:—

The Two-Unit Portable

Exceptional Quality Combined with Compactness

Constructional Details with Complete Wiring Diagram, Published in the Issue of June 23rd, 1933

A SELF-CONTAINED set in which extreme portability and easy stowage have been secured, not by sacrificing performance but by dividing the weight and bulk into separate units, which may be interconnected in a moment. One of the containers accommodates the receiver proper and the L.T. battery, while in the other is mounted a permanent-magnet moving-coil loud speaker and H.T. battery. The set is especially intended for transport in cars, caravans, motor boats and yachts, and has proved to be much more convenient than the ordinary portable.

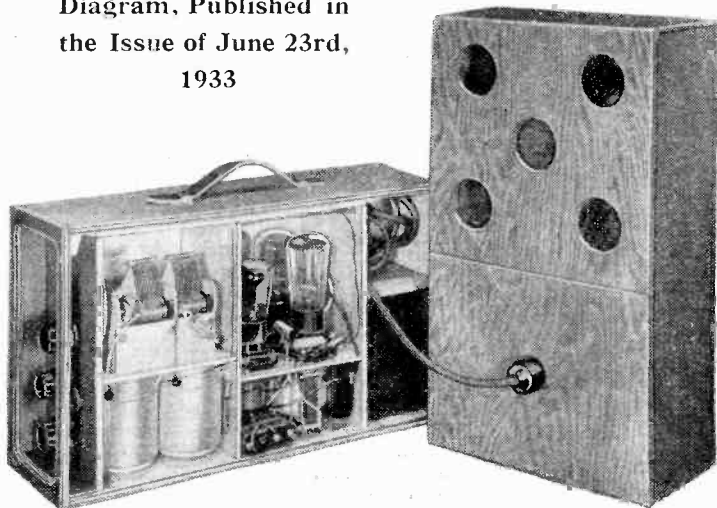

Cossor Receiver

MODEL 3456

A Battery Console with Class "B" Amplification

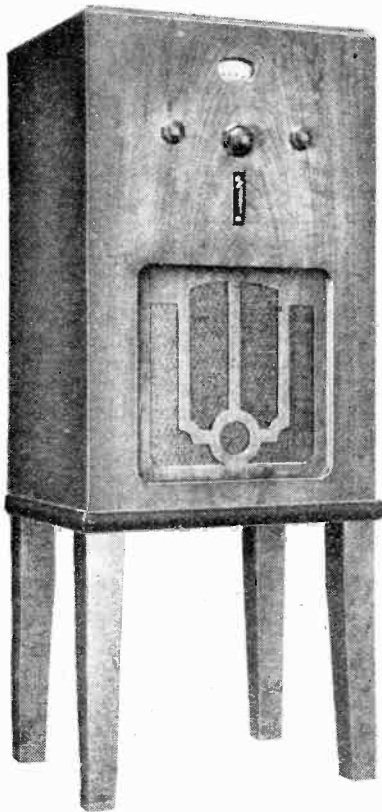

FOR a set costing less than £10 there can be no doubt that the Cossor Model 3456 presents an imposing appearance. It can be used either as a table model or a console, as the legs, which are held in position by dowel pegs and winged nuts, are readily detachable. The dimensions of the cabinet itself are 14in. x 11in. x 23in. high, and with the legs fitted the overall height is 35in.

In the matter of volume and quality a set must live up to its appearance, and, thanks to Class "B" amplification in the output stage, the Cossor set is able to do this with a surprisingly small drain on the H.T. battery. A permanent magnet moving coil loud speaker is fitted as standard, and the power output is at least one watt.

The circuit arrangement is straightforward, and there are four stages. A variable-mu screen grid H.F. valve is followed by a grid detector, with reaction, and a driver valve feeding the push-pull Class "B" output valve. Two tuned circuits are employed, one

in the aerial circuit and the other as a tuned anode coupling between the H.F. and detector stages. To ensure adequate selectivity both circuits are centre-tapped and a short-circuiting switch is arranged to preserve the symmetry of the circuits, both on long and medium waves. On long waves an H.F. choke is included in the aerial lead for the purpose of suppressing interference from nearby transmitters working on the medium wave-band. A two-ganged condenser of substantial construction with slotted end vanes is used to tune the circuits, but to ensure perfect alignment at any point in the wave-range of the set, a trimmer is connected in parallel with the section of the condenser tuning the aerial circuit. Volume is controlled in the H.F. stage by varying the grid bias of the variable-mu valve by means of a potentiometer connected across the 9-volt grid bias battery. It will be seen from the circuit diagram that the on-off switch has three contacts which simultaneously disconnect the L.T., H.T. and grid bias circuits. Reaction is capacity controlled and transformer coupling is used throughout the L.F. stages. All the H.T. supply circuits are thoroughly decoupled.

The steel chassis has been given an oxidised "gun" finish, which is both durable and attractive in appearance. A screw-type holder is fitted in an accessible position at the back of the chassis for a flashlamp fuse, and there is also a pick-up plug and jack.

FEATURES.

Type.—Four-valve battery receiver in convertible console or table model cabinet. Permanent magnet moving coil loud speaker. Class "B" amplification. Provision for gramophone pick-up. **Circuit.**—Variable-mu screen grid H.F.—grid detector with reaction—driver valve—Class "B" output valve. **Controls.**—(1) Main tuning (with trimmer). (2) Volume control and on-off switch. (3) Reaction. (4) Waverange. **Price.**—(excluding batteries), £9 19s. 0d. **Makers.**—A.C. Cossor Ltd., Highbury Grove, London, N.5.

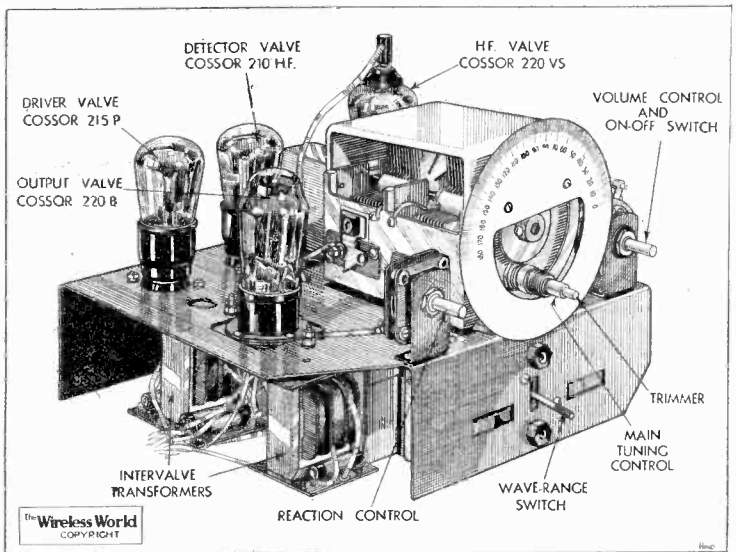

The framework of the Cossor model 3456 chassis is constructed of oxidised steel.

The controls on the front panel consist of a slow-motion main tuning knob, through the hollow spindle of which is passed the trimmer control. On the left is the reaction condenser control and on the right the combined volume control and on-off switch. Change of wave-range is effected by a lever-type switch immediately below the main tuning control.

The range and selectivity of the set are largely governed by the skill with which it is handled. It is important to realise that the main tuning, trimmer, and reaction controls are to some extent interdependent, and it is often possible to improve selectivity when receiving stations near in wavelength to the local station by first reducing the separate volume control and then increasing reaction. Familiarity with the routine of accurately tuning is soon acquired, and the full capabilities of the set will then be realised. We found no difficulty in London in tuning-in Langenberg clear of Northern Regional in daylight, and in separating the two Brookmans Park transmitters sufficiently to receive five or six foreign stations in the wavelength interval between them. The long-wave selectivity was also sufficient to separate Radio Paris, Daventry, and Eiffel Tower, but not quite adequate for uninterrupted reception of Zeesen. Taken all round the selectivity would satisfy all reasonable requirements, and is particularly good, in view of the fact that only two tuned circuits are employed.

The quality of reproduction is well-balanced, and there is no trace of cabinet resonance. The volume can be increased to a level far in excess of that required for the average living room before distortion due to overloading is apparent.

A measurement of the H.T. consumption under working conditions showed the normal standing current to be 4 mA. and the maximum consumption on sustained loud passages 15 to 16 mA.

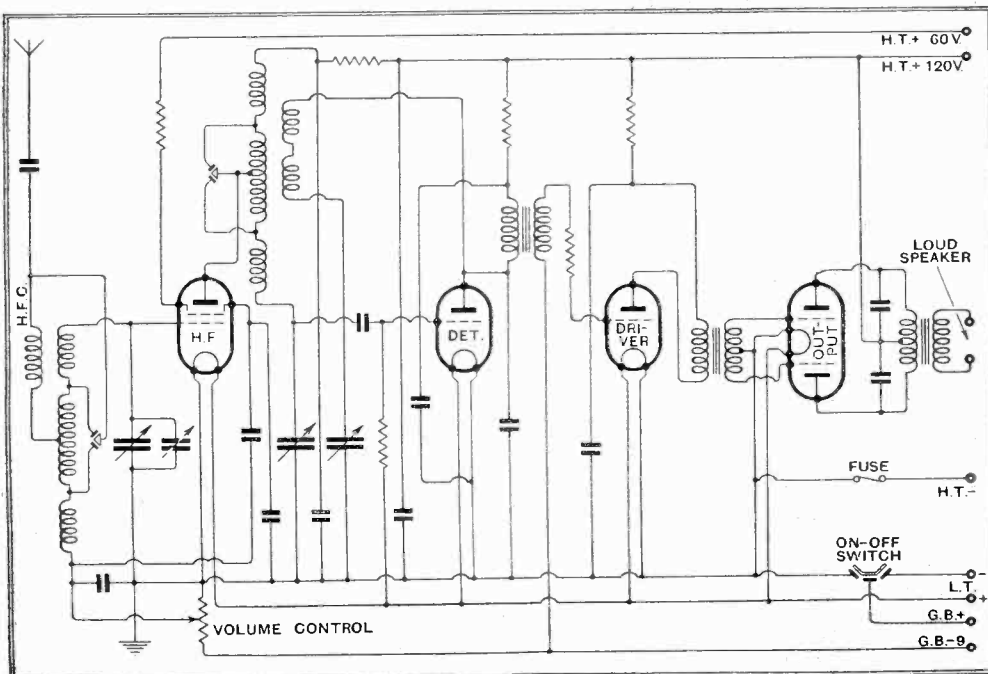

Simplified circuit diagram in which the connections of the pick-up jack are omitted.

READERS' PROBLEMS

Spoiling Circuit Alignment

ACCORDING to a correspondent, the "ganging" of his battery-operated receiver has been greatly impaired by the substitution of a variable-mu valve for one of the ordinary S.G. type. Circuit diagrams showing the arrangement of the receiver before and after the alteration are submitted, and we are asked to say what is likely to be wrong. Ganging was originally particularly good, but now the H.F. grid circuit does not remain in alignment over the whole tuning scale.

The original arrangement of this circuit is shown in Fig. 1(a); the grid bias cell was shunted by a capacity of 0.005 mfd.; the same condenser was employed in association with a decoupling resistance when the variable-mu valve was fitted.

Consideration of diagram (b) will show that this condenser is now in series with the tuned circuit, while originally it was more or less completely short-circuited by the bias cell; indeed, while this cell had a low internal resistance, it was probably serving little use-

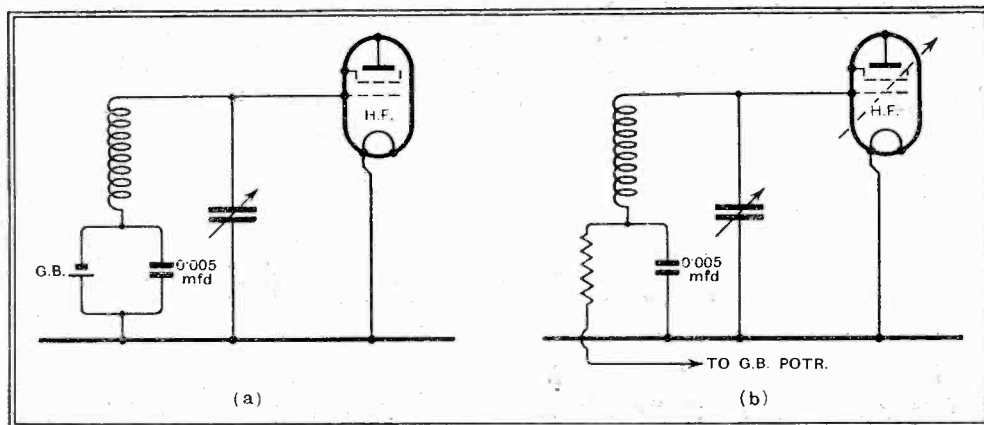

Fig. 1.—The by-pass condenser in diagram (a), though in series with the tuned circuit, is virtually "shorted" by the bias cell, and generally has little effect on tuning.

ful purpose. Now a capacity of 0.005 mfd. is only ten times greater than that of the tuning condenser, and so it is bound to exercise a certain effect on the "law" of that condenser. This, we think, explains entirely why the H.F. grid circuit runs out of tune, and we think that matters will be put right by the fitting of a condenser having the more usual value of about 0.1 mfd.

Old-Type Field Windings

A NUMBER of energised moving-coil loud speakers designed a few years ago were fitted with low-resistance windings designed for working at some 10 or 12 volts, or even less. Where A.C. mains were employed, energising current was obtained through a low-voltage rectifier, generally of the metal oxide type.

Several readers have asked how this type of low-voltage loud speaker can be adapted to work with modern sets in which the field winding is usually employed for smoothing.

We think that the best advice we can offer is that the loud speaker should be used with its existing energising equipment, and without any alteration. When a design calling for a high-resistance field winding is being followed, a special type of choke, having the necessary D.C. resistance, should be substituted for the field.

THESE columns are reserved for the publication of matter of general interest arising out of problems submitted by our readers.

Readers requiring an individual reply to their technical questions by post are referred to "The Wireless World" Information Bureau, of which brief particulars, with the fee charged, are to be found at the foot of this page.

According to Plan

THE user of an A.V.C. Monodial appears to be mildly perturbed because complete removal of the control valve from its socket does not bring about any reduction in signal strength. We are asked to say whether this effect is indicative of a fault, and if so, to suggest where it may lie.

When receiving a rather feeble signal—too weak to reach the threshold value at which the A.V.C. system comes into operation—it is quite natural that removal of the A.V.C. valve should have no audible effect. But, if the signal is strong, removal of the valve should be accompanied by an increase of

Trite, but True

"MY receiver works perfectly on the medium waveband, but fails to give any signals whatever on the long-wave side." The reader who makes this statement in a letter asking for our assistance gives insufficient information for us to suggest the probable location of the fault, and we can do little more than remind him that it must logically be assumed to lie in some circuit or some component that is peculiar to the long waveband, and inoperative on medium waves.

In nine cases out of ten, faults such as those described are due to defective long-wave sections of tuning coils, or to badly working wave-range switches.

Mounting By-pass Condensers

IN the Two-Unit Portable Receiver (*The Wireless World*, July 23rd), space was saved by mounting the tubular by-pass condensers C₄ and C₅ under the screening covers of the associated tuning coils. A prospective builder of this set tells us that the condensers he has obtained are too large for fitting in this way, and asks whether any harm will be done by mounting them externally.

This alteration is permissible. Although the set is compact it is not so cramped that room will not be available for the condensers elsewhere. To avoid risk of instability, however, they should be mounted in close proximity to the tuning coils.

A.C. Short-wave Sets

IT is common knowledge that mains-operated receivers working on the short waves are particularly likely to suffer from modulation hum, and, further, that this trouble is likely to be provoked when the earth connection is poor.

A user of the A.C. Short-wave Converter (*The Wireless World*, April 28th) notices a certain amount of hum, and has found that it has become rather less troublesome since his earth connection was improved. But further improvements in this direction are unfortunately impossible, and our correspondent goes on to ask whether we can suggest anything else.

We recommend that some simple form of H.F. stopping device should be fitted in the mains feed to the receiver with which the converter is used. Probably a pair of 0.001 mfd. condensers, connected across the primary of the power transformer, as in the converter unit itself, will serve the purpose.

The Wireless World

INFORMATION BUREAU

THE service is intended primarily for readers meeting with difficulties in the construction, adjustment, operation, or maintenance of wireless receivers described in *The Wireless World*, or those of commercial design which from time to time are reviewed in the pages of *The Wireless World*. Every endeavour will be made to deal with queries on all wireless matters, provided that they are of such a nature that they can be dealt with satisfactorily in a letter.

Communications should be addressed to *The Wireless World* Information Bureau, Dorset House, Stamford Street, London, S.E.1, and must be accompanied by a remittance of 5s. to cover the cost of the service. The enquirer's name and address should be written in block letters at the top of all communications.

Getting it Both Ways

A QUERIST, who has inserted an anti-H.F. filter in the supply leads from the mains to his receiver, finds that background noises have been reduced to a more than acceptable extent, and that reception is generally more pleasing than before.

But never a rose without a thorn! Our querist occasionally finds it necessary to use a mains aerial, and the trouble is that this device has now become very much less effective than it was before the filter was added. We are asked if anything can be done to restore the lost sensitivity.

The fact that the addition of a mains filter reduces the effectiveness of the mains wiring as a collector of signals is eloquent testimony to the efficiency of the filter that has been fitted. After all, it should be borne in mind that these filters are intended to deflect stray H.F. energy in the mains from the receiver; they cannot be expected to discriminate between wanted and unwanted H.F. currents, and so little or nothing can be done.

All this goes to show that a mains aerial is a device that should only be used when nothing better is possible.

The Wireless World

THE
PRACTICAL RADIO
JOURNAL
23rd Year of Publication

No. 729.

FRIDAY, AUGUST 18TH, 1933.

VOL. XXXIII. No. 7.

Proprietors: ILIFFE & SONS LTD.

Editor:
HUGH S. POCOCK.

Editorial,
Advertising and Publishing Offices:
DORSET HOUSE, STAMFORD STREET,
LONDON, S.E.1.

Telephone: Hop 3333 (50 lines).
Telegrams: "Ethiaworld, Watloo, London."

COVENTRY: Hertford Street.

Telegrams: "Cyclist, Coventry." Telephone: 5210 Coventry.

BIRMINGHAM:

Guildhall Buildings, Navigation Street, 2.

Telegrams: "Autopress, Birmingham." Telephone: 2970 Midland (3 lines).

MANCHESTER: 260, Deansgate, 3.

Telegrams: "Iliffe, Manchester." Telephone: Blackfriars 4,112 (4 lines).

GLASGOW: 26B, Renfield Street, C.2.

Telegrams: "Iliffe, Glasgow." Telephone: Central 4857.

PUBLISHED WEEKLY. ENTERED AS SECOND
CLASS MATTER AT NEW YORK, N.Y.

Subscription Rates:

Home, £1 1s. 8d.; Canada, £1 1s. 8d.; other
countries abroad, £1 3s. 10d. per annum.

As many of the circuits and apparatus described in these
pages are covered by patents, readers are advised, before
making use of them, to satisfy themselves that they would
not be infringing patents.

CONTENTS

	Page
PROGRAMMES FROM ABROAD, pp. 1—XXIV	
Editorial Comment	117
Aerials Up to Date	118
Unbiased	120
Progress in Receiver Design	121
Pentode or Triode?	129
Sidelights on Olympia	131
Practical Hints and Tips	132
Foreign Stations	133
News of the Week	134
Notes on the New Monodial Super	135
New Components and Accessories	137
Broadcast Brevities	143
The Problem of Electrical Inter- ference	144
Loud Speaker Tendencies	145
The New Valves	147
Readers' Problems	148

EDITORIAL COMMENT

Wireless and the Mains What Rate should be Charged?

THE electrical industry collectively attaches much importance to the increase in the popularity of wireless because it is an added inducement to the public to become consumers of electricity since electricity provides such a very convenient means of operating a wireless set, and from this beginning the employment of current for lighting and other domestic purposes follows.

It is because of this recognition of the importance of wireless sets by the electrical industry as a whole, that we feel justified in continuing our criticism of those distributors of electricity who have not yet had their eyes opened to the folly of their attitude in endeavouring to penalise consumers by continuing to insist that wireless sets must be connected to the lighting mains and not supplied at the power rate.

We must admit that we are distressed, too, to find that our esteemed contemporary, *The Electrician*, in a recent issue criticises our attitude in stating that wireless sets should be connected to the power circuit. *The Electrician* states in a Leader: "Even our contemporary, *The Wireless World*, in its issue of July 14th, goes rather far in criticising supply undertakings which insist on current for wireless receivers being taken through the lighting meter," and the article continues with the suggestion that a wireless set should be connected to the lighting circuit for the reason that it does not constitute a "power load." We believe that we are right in taking the view that the question of "power load" does not come into the argument. If we exclude from the lighting circuit any domestic apparatus which does not constitute a "power load,"

then, on the question of "load," domestic irons, kettles, fans and, in fact, almost anything other than heating appliances, would have to be fed through the lighting meter.

We believe that it is only reasonable to insist on the lighting rate being applicable where lamps are used for the purpose of illumination.

Supply authorities are *privileged* to charge a higher rate for illumination and it is an abuse of this privilege to attempt to compel the consumer to pay the lighting rate for any other purpose than illumination. If this view is wrong, our correspondence pages are open to any supply undertaking which cares to argue the point. In the meantime, we should welcome communications from any readers who, in their districts, are troubled over this attitude of suppliers.

We feel that publicity should be given to a matter of this kind, which is not only irksome to the consumer but definitely hampers the extension of the use of electricity for domestic purposes.

The Show

A Survey of Progress

IN this issue, which comprises the second of our three special Olympia Show numbers, we include a series of articles surveying the progress which has been made in various branches of wireless since last season, as portrayed by the exhibits at Olympia.

In almost every direction substantial development has taken place, and our object in this issue has been to try to indicate to our readers the outstanding tendencies rather than to give a detailed report on the exhibition as a whole; a report of this nature will, however, be included next week, when every manufacturer's exhibit will be dealt with individually.

Aerials Up to Date

An Important But Neglected Accessory

By H. F. SMITH

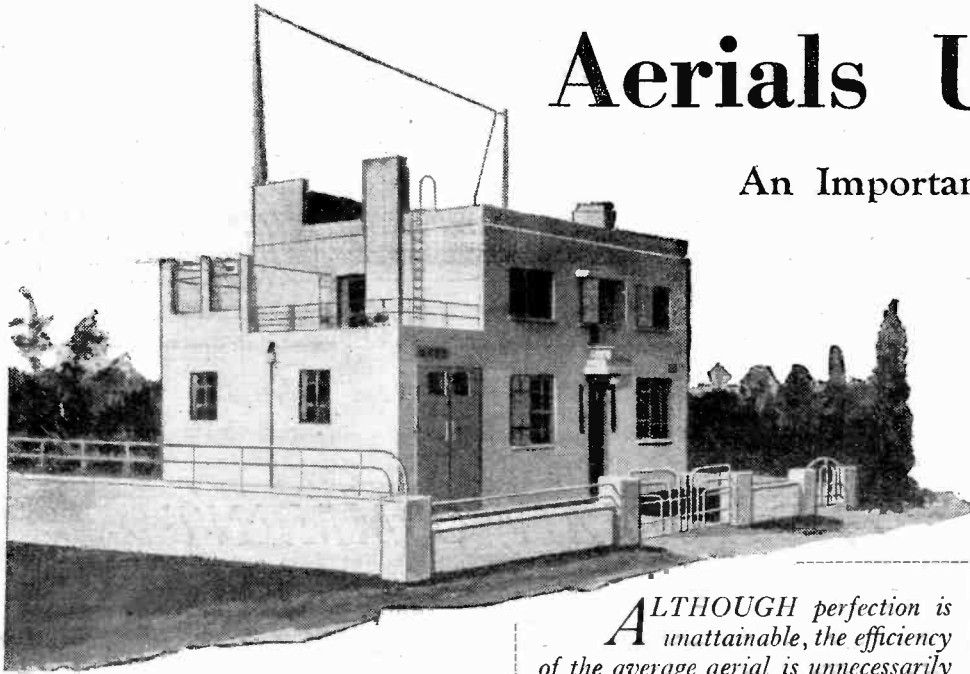

ALTHOUGH perfection is unattainable, the efficiency of the average aerial is unnecessarily low. This article explains the few simple rules which lead to better results, and, from an entirely practical point of view, deals with the use of screened aerial down-leads as a palliative to man-made static.

EVER since the earliest days of radio communication the external aerial has been a bone of contention. Technicians point out, quite rightly, that a good aerial is still, as it always has been, a vital necessity for which there is no real and entirely satisfactory substitute. Those who are mainly concerned with æsthetic considerations do not hesitate to condemn it roundly as a blot on the landscape. Viewing the subject dispassionately, both sides deserve a certain amount of sympathy.

In spite of continued improvements in the sensitivity of our receivers, a great deal of efficiency is sacrificed by using an ineffective form of collector; true, the frame aerial has its own special advantages, but in the best form is hardly practical for domestic use. Probably the greatest advantage of a good aerial is that it tends to reduce background noises.

To do its job properly an aerial must be high, and therefore conspicuous; here a loophole is given for the critics, but many of them will admit that although a lofty aerial is out of keeping with old-world surroundings it fits in quite happily with the modernistic style of building. Architects are displaying a welcome tendency to make proper provision for an aerial, and in several cases are putting up a mast (or masts) as a part of the general scheme. One of several such arrangements observed by a *Wireless World* artist is illustrated at the head of this article; here the building is of ferro-concrete, and the aerial masts are of the same material.

Almost everyone knows that, as already implied, height is a vital factor in aerial design. But the effective height of an

aerial is determined not so much by its elevation above the ground as by its height with relation to adjacent earthed or semi-earthed bodies. An aerial erected 20ft. above the roof of an 80ft. metal-framed building has an effective height, not of 100ft., but of 20ft. only. Too much emphasis cannot be laid upon the need for keeping the aerial well clear of all such obstructions as roofs, metal guttering, and walls; this applies both to the horizontal portion and to the down-leads.

One often sees fearsome multiple-wire aerials which presumably have been erected in the fond hopes that their receptive powers will be greater than that of a single wire, which is much easier to put up and which is certainly less conspicuous and offensive to the eye.

Aerials that are otherwise workmanlike and effective are often marred, particularly as regards their appearance, by a

straggling, unsupported down-lead. It is seldom that a proper guy rope, with, of course, an extra insulator, cannot be so arranged as to improve matters in such cases.

There is little need to discuss at length the actual constructional details of an aerial. The simplest possible arrangement, as illustrated in Fig. 1, is generally the best; here a single wire, continuous from the inside of the lead-in tube to the extreme end, is shown. All external joints should be avoided: the resistance of such joints, however well made, is likely to become seriously high, and even if they are soldered the mechanical strength of the wire is likely to be impaired.

Opinions differ as to the best type of wire to use, and it is doubtful whether the classical seven-stranded hard-drawn copper can be bettered. It is flexible, and therefore easy to handle, and is usually

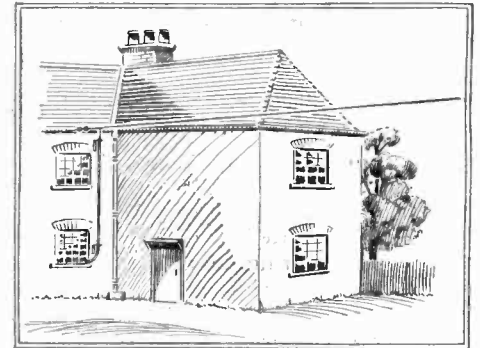

Fig. 2.—An example to be avoided, whether for a screened or unshielded aerial.

strong enough mechanically. Probably the only valid objection that can be urged against it is that if several strands become broken after each individual wire has accumulated a more or less insulating film of corrosion, very puzzling effects can arise when the aerial is used for short-wave reception. This explains why a single strand of No. 16 hard-drawn copper is sometimes preferred; phosphor bronze would be still better, but is unpleasant to work; it should always be thoroughly stretched before making the aerial.

A Weak Link

Good lead-in insulators, through which the aerial connection is taken into the building, are few and far between, and it is for this reason that a plain insulating tube, through which the aerial wire itself may be passed, without the need for an external joint, is suggested in Fig. 1. There are, however, a few commercial insulators of good design; but even so especial care should be taken in making connection to the outer terminal.

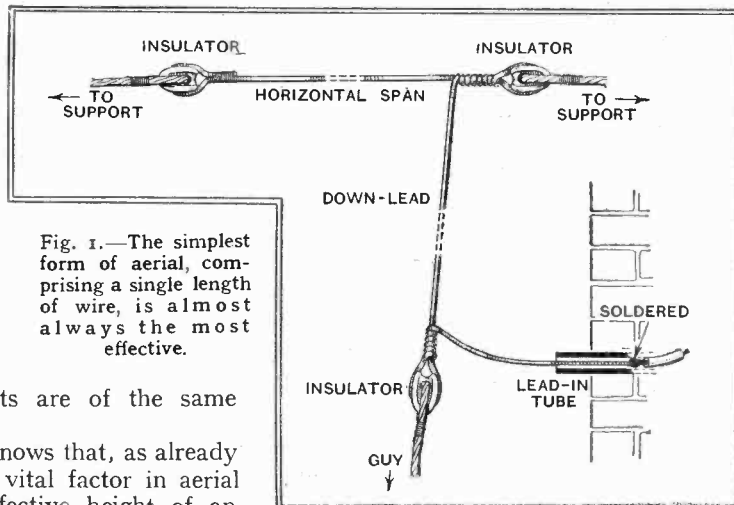

Fig. 1.—The simplest form of aerial, comprising a single length of wire, is almost always the most effective.

Aerials Up to Date.--

Partially shielded aerials, which help to minimise electrical interference, are a recent innovation, to which much attention is now being paid. Before discussing the practical aspects of this subject it

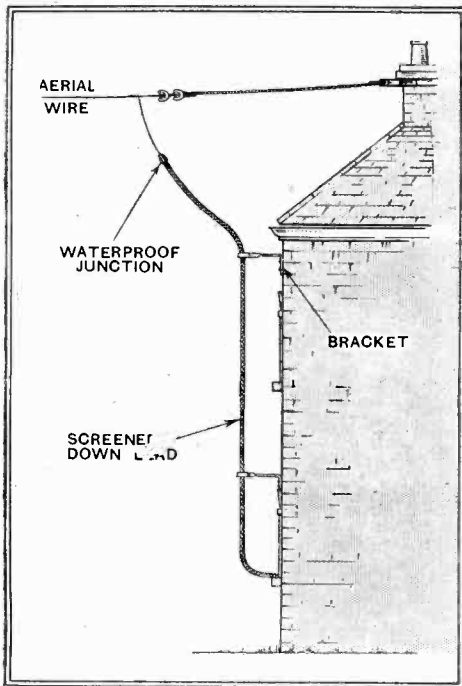

Fig. 3.—A suggested method of installing a screened aerial. The unshielded portion is well clear of sources of interference.

should be made clear that the practice of shielding the aerial down-lead is bound to decrease sensitivity, though in favourable circumstances the loss may be negligible. Further, it is only likely to be effective in preventing interference of the kind which is disseminated and reradiated by the electrical wiring (or even the water or heating pipes) of the house in which the receiver is installed. Perhaps this does not sound very encouraging, but recent investigations show that a surprisingly large proportion of man-made static reaches our sets in this way.

A shielded down-lead is worse than useless unless carefully installed with some appreciation of its proper function. For instance, a case was recently investigated where no improvements whatsoever in noise-to-signal ratio was made by fitting one. It was found that matters were arranged in very much the manner depicted in Fig. 2; the horizontal span of the aerial ran for 20 or 30 feet of its length within a foot or two of the eaves of the house, and so was in just as bad a position to pick up interference from the house wiring, etc., as the down-lead itself.

Regular readers will be aware that for shielding the down-lead, special low-capacity cable, such as that made by Goltone, or British Radiophone, is essential; ordinary rubber-covered wire with an external metal braiding is quite useless unless special precautions to be described later are taken.

The user of this cable should bear in mind the desirability of screening just enough, and no more, of the aerial; only

that part of it which is likely to be influenced by the field of interference should be shielded. A successful installation is sketched in Fig. 3; it will be seen that the down-lead is shielded up to a point well clear of the building to which the "home" end of the aerial is attached. In order to relieve the aerial supports as much as possible of the considerable weight and windage of the screened cable, the latter is supported by a bracket at the highest possible point. As an alternative, the waterproof insulator fitted at the junction between the unshielded and shielded parts of the down-lead might be mounted on the top bracket, but it has been found that in some instances this plan results in insufficient spacing between the unshielded part of the aerial and the building. Similarly, it is desirable that the screened down-lead should be carried right down to the aerial terminal of the set.

Another Method of Screening

Although we speak of "screened down-leads," it does not necessarily follow that maximum immunity from interference is obtained by shielding the vertical wire. Where it is possible to erect the entire aerial well clear of the sources of interference, better results are sometimes obtained by fitting a shielded horizontal lead-in, as in Fig. 4. This sketch depicts an aerial system of which the writer had personal experience. As it was installed some time ago, before low-capacity shielded cable became available, a length of metal tubing, about 1 in. in diameter, with the conductor wire carefully centred in it, and with a minimum of solid dielectric material, was used for the lead-in. By cleating this tube to the wall it was found possible to arrange the lead-in quite neatly and inconspicuously.

Still referring to Fig. 4, it may be pointed out that in many instances matters would be greatly improved by fitting an inverted "L" aerial instead of

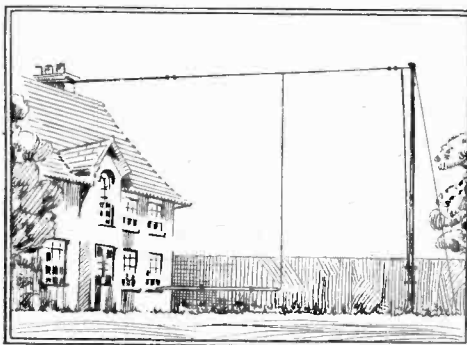

Fig. 4.—A variation of the usual type of shielded aerial; the horizontal lead-in wire is screened.

a "T" as illustrated. Especially is this likely to be the case if radiation of interference were taking place from electrical wiring in the upper part of the building in such a way that it would affect the nearer horizontal limb of the aerial. By considering these matters carefully it is

often possible to obtain highly effective shielding by using no more than 15 feet of metal-braided cable; in such a short length the losses should be almost negligible.

A further advantage of the shielded horizontal lead-in, as opposed to the shielded vertical down-lead, is that the signal pick-up of an aerial embodying the former arrangement is likely to be considerably better. However, no hard-and-fast rule can be laid down; each case must be treated on its merits, and anyone who is proposing to try the effect of a shielded aerial would be well advised to experiment with various arrangements before supporting brackets, etc., are finally mounted in position.

The most highly developed, and in some respects the best, form of anti-inter-

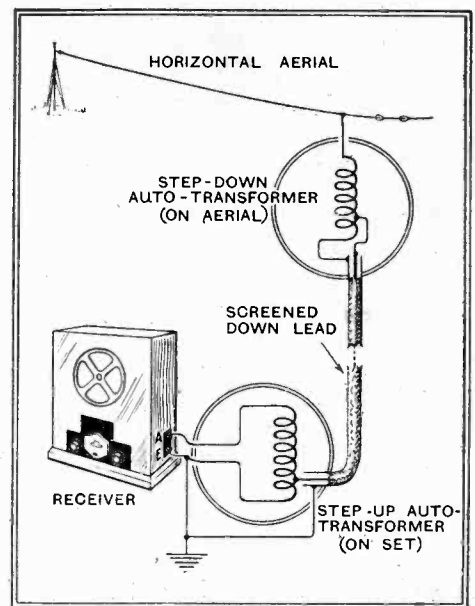

Fig. 5.—Schematic diagram to show the use of impedance-matching transformers whereby losses in screened aerial down-leads may be avoided.

ference aerial is so arranged that the losses in the screened cable are minimised by the principle of impedance-matching; in effect, signal impulses are passed through the shielded line at low voltage, and then again stepped-up before being applied to the receiver.

This involves the fitting of two transformers; as one of these must be mounted on the aerial itself, at the junction point between screened and unshielded sections, switching is obviously impossible. In America, where this scheme has been widely adopted, broadcasting is carried out on the medium waveband only, and so this difficulty does not arise. In this country the task of designing transformers to cover both medium and long waves is being energetically pursued, and by the time this article appears it seems probable that they will be available commercially. One of the great advantages of the impedance-matched transmission line system, as it is called, is that ordinary high-capacity braided cable, which is relatively cheap, may be employed instead of special low-capacity cable.

UNBIASED

BY FREE GRID

My Show Report

UNFORTUNATELY I have been laid low by a bad cold caught while bathing off Southend beach on Bank Holiday, and so was unable to make my customary visit to Robolympia on the opening day of the eighth Olympiad. I have, in fact,



To their intense surprise.

only just finished a hasty preliminary scramble round the stands, and so am quite unable to furnish you with my usual full report.

Short as the time has been, however, it was unhappily more than sufficient to bring home to me again the fact that my old friends the manufacturers, like the Bourbons of old, "have learnt nothing and forgotten nothing." The same old Lingolympia held sway. Enquiries for technical information led to the same charming and would-be-disarming smile from the bathing beauties who adorned the various stands, and to the same "hot air" from the tailors' dummies who hung about in the offing. There were, however, certain notable exceptions, especially among the valve manufacturers, who had completely reformed; in one particular case I found that the fort was held, speaking both literally and metaphorically, even during the height of the luncheon hour.

At one particular stand (no names no pack drill) the salesmen were so vociferous in their efforts to sell me a certain set that they had trouble with their sibilants, and I was compelled to put up my umbrella in self-defence. To their intense surprise no less than my own, their "hot air" proved so powerful that my umbrella was caught up in it, and willy nilly I was raised from the floor and managed to make my escape *via* the gallery.

My Missing Medals

I WAS extremely interested in the *con-tretemps* which occurred with the Baden-Powell broadcast the other night as it reminded me of a somewhat similar mishap which came my way in the very early days of European broadcasting, and which some of you who used to listen to the Continental stations some ten years ago may recollect.

It so happened that I had arranged to give a talk from a broadcasting station in the capital of a certain country with whose language I am familiar. I was due at an official reception later on the same evening and, as etiquette demands, donned my full regalia of decorations which the rulers of that particular country had from time to time seen fit to confer on me for services rendered. I left my hotel in good time for the broadcast, but to my dismay found that a lightning taxi strike had developed. As there appeared to be no conveyance of any type available, I entered a telephone box to acquaint the station director with my predicament.

He was nothing if not resourceful, and suggested that I should give my talk there and then, the telephone earpiece being held close to the broadcasting microphone.

While the problem was thus satisfactorily solved at the broadcasting station, I had several little troubles of my own in the telephone box, and was far from happy. I was interrupted every few minutes by the voice of the girl at the telephone exchange demanding the local equivalent of "another tuppence," and as these little "asides" were all broadcast I learnt from the newspapers next morning that my talk, which was of a very serious and intimate nature, had been mistaken for a comic turn, and they gave me unstinting praise, as a result of which my post bag was full to bursting with offers from music halls.

This was by no means the end of my troubles, however, as the telephone box was besieged by a large and menacing crowd who were waiting to phone. My greatest difficulty, however, was the money question. The repeated demands of the telephone girl speedily exhausted all my small change, and my talk was in grave danger of being cut off when suddenly I remembered the

medals to which I have already referred. Fortunately they were just the right size, and as the country in question had estimated my services at a high value they were also numerous and just managed to last out my talk.

Thus a delicate situation was saved, but I fear that at the subsequent banquet that evening I was looked at askance as being the only undecorated individual in the room. I was quite unable to explain, as naturally it would have caused the utmost indignation had I revealed to what base purpose I had put some of the highest distinctions which a country can bestow.

Automatic Stenographer

I SEE that according to a report from Germany a well-known scientist of that country has just developed an automatic stenographer based on radio principles. It appears that it (or should it be she?) consists of a microphone coupled to a powerful valve amplifier which is arranged in some mysterious manner so that when words are spoken into the microphone the typewriter is caused to knock them out on the paper in the usual way. "In this manner," states the report, "the spelling errors of the ordinary female stenographer are avoided and, moreover, owing to its lightness and compactness, the 'automatic stenographer' can be taken on the knee with impunity."

I am quite at a loss to understand the meaning of the last part of this sentence. Whether it is intended as an uncomplimentary reference to the weight of ordinary stenographers, or something far more subtle, I cannot say. Perhaps some

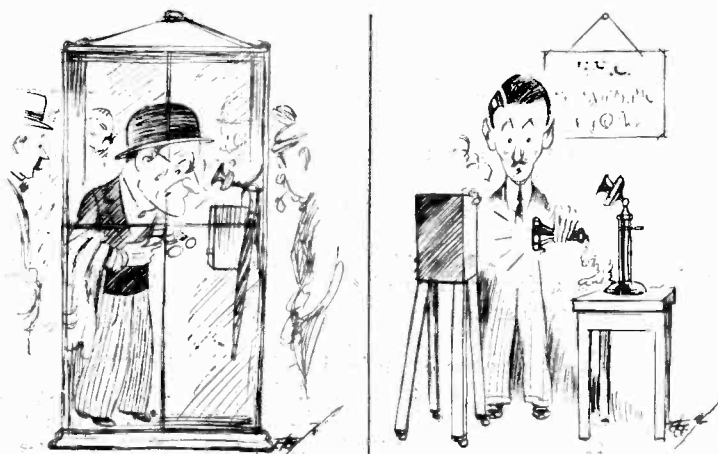

I had troubles of my own, and was far from happy.

reader with a special understanding of Teutonic psychology can help me out of my difficulty, for, speaking personally, I have never found that stenographers are unduly heavy.

PROGRESS IN RECEIVER DESIGN

Outstanding Features of New Sets on the Stands at Olympia

THE most striking trend in superheterodyne development at Olympia is undoubtedly towards the set of only four or five valves. The term superheterodyne has been associated for so many years with large and ambitious types of receiver that it comes as something of a shock to find that it is used to describe receivers which are much smaller than many straight sets of the past.

The superheterodyne can no longer be considered a luxury receiver, for while it is true that the largest and most expensive sets are of this type the smaller specimens cost no more than straight sets of equivalent sensitivity. This important change has been brought about chiefly by the need for increased selectivity, and the reduction in the number of valves necessary has occurred more through improvements in design than through the introduction of multiple-type valves. Surprising as it may seem, the use of these new valves is generally confined to the larger class of receiver.

Owing to these present tendencies it is no longer convenient to class all superheterodynes together, for the extremes in type are no longer capable of giving even an approximately equal performance, and it is now necessary to divide them into at least two distinct classes. While there is now much to be said for a classification which is not based upon the number of valves employed, this still remains a convenient basis, inasmuch as it gives the purchaser some idea of the running costs in

six valves or more fall automatically into the larger category.

The smaller type of receiver, as might be expected, shows considerable uniformity among the different specimens. The general trend is to use a band-pass input tuning circuit feeding a single valve detector-oscillator for the frequency changer. A single I.F. stage with band-pass type intervalve couplings is used, with

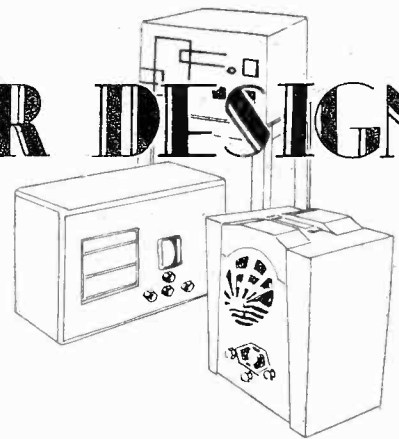

detector and the output stage. Battery sets thus usually incorporate one more valve than the equivalent mains types, not counting the H.T. rectifier of A.C. models. The numerous six-valve class of battery superheterodynes, therefore, is most conveniently included with mains sets of four or five valves, although a six-valve mains set would be classed among the larger types.

Examples of this general trend are to be found on the stands of Bush Radio, General Electric Co., Halford, Higgs, H.M.V., Marconiphone, Standard, Sunbeam Electric, and Ultra Electric. Quite a number of the small superheterodynes, however, do not conform to this general practice, and some models are of considerable interest. The Alba Model 54, for instance, has an intermediate frequency of 473 kc/s instead of the usual 110-125 kc/s, with the result that an input band-pass filter is considered unnecessary, and a single tuned aerial circuit is employed. The Kolster-Brandes 444 set has only four valves, including the H.T. rectifier, so that it is really a three-valve superheterodyne, and it is probably the smallest example of this type of receiver on view. The City Accumulator Co. have a five-valve model, including the rectifier, which follows the lines of well-tried practice, but is one of

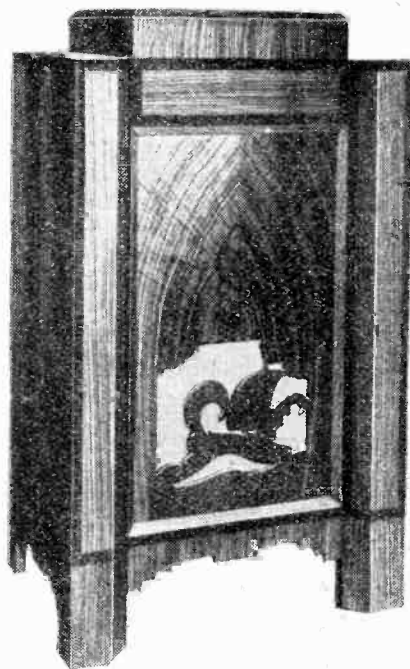

Varley radio-gramophone with A.V.C. obtained through a duo-diode-triode second detector

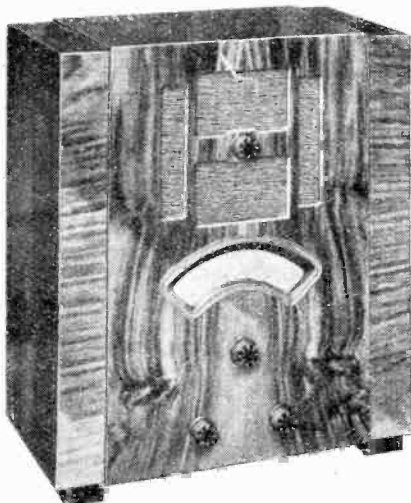

G. E. C. Five-valve superheterodyne with a detector-oscillator frequency changer

valve replacements, and the old general rule of the greater the number of valves the better the performance still holds good. The small class of superheterodynes, therefore, may well be considered as that of sets with five valves or less, while those with

a second detector and a pentode output valve. In nearly every case the single valve frequency changer employs a non-variable- μ type H.F. pentode for the tuned oscillator circuit connected in, or coupled tightly to, the anode circuit, the reaction being provided by means of a small coil connected in the cathode lead of the valve. A frequency changer of this type is capable of very high efficiency, approaching that of a good two-valve arrangement, and where the initial ganging adjustments are carried out in the factory it can be entirely satisfactory.

It is the general practice to use a variable- μ type of H.F. pentode for the I.F. stage, and to control the grid bias of this valve for the volume control. More divergency exists in the L.F. circuits and the second detector, and the division between a grid detector with transformer coupling and an anode-bend detector with resistance-capacity coupling is probably about equal. In the case of battery sets, of course, the Class "B" output stage is practically universal, and a driver valve is invariably included between the second

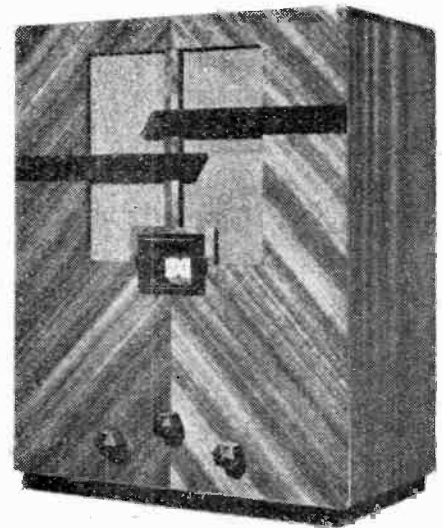

The Standard 40 receiver, which is fitted with H.F. pentode valves

the first British commercially manufactured receiver to use the Pentagrid valve for the frequency changer. This has rendered possible the bias control of two valves for volume control.

Progress in Receiver Design—

Ekco sets are this year to be classified by stages; their seven-stage model employs four multiple valves, including a duo-diode-triode, which provides delayed A.V.C. Apart from its technical features, this set represents a new tendency in cabinet design, all models being housed in modernistic bakelite cabinets. The most unusual design is in black, relieved with chromium insets.

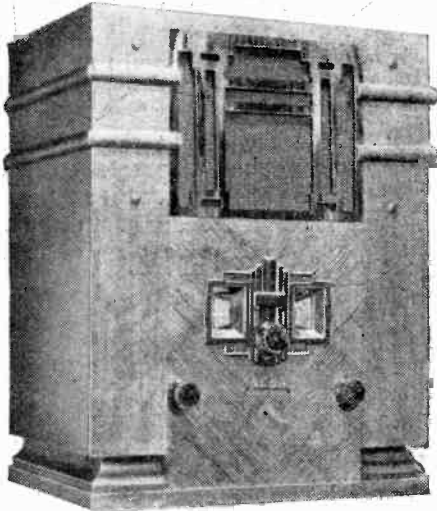

Alba Superheterodyne, with a frequency of 475 kc/s.

The Varley Model AP46 is unusual in that it includes a variable- μ H.F. stage before the detector-oscillator and has no I.F. amplifier. The I.F. circuits consist simply of a band-pass filter, to which reaction is applied, coupling the frequency changer directly to the second detector. A larger model, the AP48, of the same firm includes a single I.F. valve as well as the H.F. stage, and it is fitted with a duo-diode-triode second detector to provide automatic volume control. The Portadyne 5/AC set is also of the five-valve type, and is fitted with A.V.C. obtained with the aid of a duo-diode-triode, while their battery model 5/B includes a detector-oscillator with a single I.F. stage, second detector, driver, and Class "B" output; A.V.C. is included.

In the larger class of superheterodyne it is hardly possible to find any general trend in design as in the case of the small sets, for the greater number of valves employed



Ferranti Arcadia Companionette with a book-shelf in the lower portion of the cabinet.

gives a great possibility of variation, of which designers have not been slow to take advantage. Automatic volume control, however, although not strictly a superheterodyne development, can at the present time be rightly considered as such by virtue of its rarity among straight sets.

Automatic volume control has been largely called into being by the development of superheterodynes of extreme sensitivity and selectivity, for these have led to a great increase in distant listening. This has often been marred, however, by fading, and some means of counteracting this has been sought, and found in automatic volume control. Although there are many different methods by which A.V.C. can be achieved, it is customary for the circuit to be arranged so that any increase in the second detector input increases the negative grid bias applied to the variable- μ valves, so reducing their amplification. Since the ear is insensitive to small changes in volume, the net result is that the apparent volume from the loud speaker remains constant for a very large change of signal input. As a result, the volume variations of fading are smoothed out, and one of its chief drawbacks is removed. In addition to reducing fading, however, an A.V.C. system prevents overloading when tuning through a strong signal.

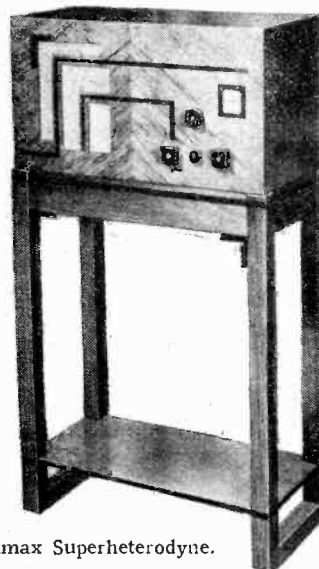

Climax Superheterodyne.

In order to avoid a drop in the initial sensitivity of the receiver, it is usual to fit delayed A.V.C., which is only another way of saying that the control is inoperative for signals weaker than a certain predetermined level. The control is usually arranged with the aid of a duo-diode-triode valve, in which one diode provides signal rectification and the other delayed automatic volume control, sometimes alone and sometimes in conjunction with the triode, while the triode portion acts as the first L.F. stage. Systems of this nature are to be found among the Columbia, H.M.V., Hustler Simpson and Webb, Kolster-Brandes, and Ultra Electric models, while the Ferranti "Gloria," the R.G.D. "702A" and "901A," and the Standard "60" are also fitted with delayed A.V.C.

The fact that A.V.C. tends to maintain

a constant detector input brings one disadvantage in its train. During the process of tuning, the controls must at times be inevitably so set that no station is received. The sensitivity of the set is

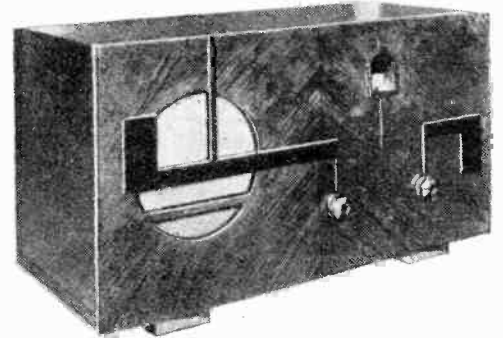

Lissen five-valve receiver, with pentode amplified A.V.C.

then at its maximum and atmospherics and any local electrical interference are reproduced at large volume. When accurately tuned to a station, an A.V.C. set, of course, is no more likely to give background noise than a receiver not so equipped, but during tuning it is noisier unless special circuits are fitted.

There are two general methods of attacking the noise problem. Many of the receivers just mentioned are fitted with a "noise suppressor switch" which permits the maximum sensitivity to be reduced at will to such a degree that the background with no signal is not excessive. The switch is kept closed during the process of tuning so that most signals give quite low volume, and when the desired station has been found it is opened for normal reception.

The alternative method is entirely automatic, but since it necessitates the use of an additional valve, it is usually found only in the largest receivers. With the quiet automatic volume control system nothing whatever is heard unless the set is tuned accurately to a station. In most cases the grid leak of the first L.F. valve is returned to earth through a high resistance included in the anode circuit of a control valve. This valve is arranged to pass current through the resistance in the absence of a signal, so that the L.F. valve is biased beyond the anode current cut-off point and is rendered inoperative. When



The Marconiphone Model 290 is fitted with D.A.V.C. and a static suppressor switch.

Progress in Receiver Design—

a signal is tuned in the current through the control valve falls to zero, and the bias on the L.F. stage is reduced to its normal amplifying value.

Although the arrangements used to obtain Q.A.V.C. in different sets may differ in detail, they all operate upon this general principle of overbiasing amplifying valve. In some cases the "quiet" control valve is operated from the output of the normal second detector, but in others a separate rectifier is provided and fed by a very sharply tuned circuit. A better Q.A.V.C. action is then obtained, and the apparent, but not the true, selectivity is greatly increased.

Most of the sets with quiet automatic volume control use a duo-diode-triode to give delayed A.V.C. with an additional valve for the "quiet" control. The receivers themselves, however, differ so much from one another that a general description is impossible. The General Electric Co.'s model, for instance, is fitted with a single tuned aerial circuit feeding a variable-mu H.F. stage transformer coupled to the first detector to which a separate oscillator is linked. There is a single I.F. stage, and a separate triode controlling valve is fitted to give the "quiet" control on the triode portion of the duo-diode-triode second detector. In the Kolster-Brandes model KB888, however, the control is arranged by the combination of a duo-diode-triode with a

degree of stability. A separate first detector, also of the pentode type, is used.

Since the action of A.V.C. is to maintain constant signal strength, it will be obvious that the usual method of tuning for the strongest signal is inapplicable. In many cases, therefore, a tuning indicator is fitted, and the set is tuned for maximum deflection of an indicator, which often takes the form of a simple milliammeter.

Although delayed diode A.V.C. is common, other systems are to be found, and in the R.I. "Madrigal" model the duo-diode-triode is used to provide amplified A.V.C. The Brunswick 6-valve receiver also includes amplified A.V.C., and

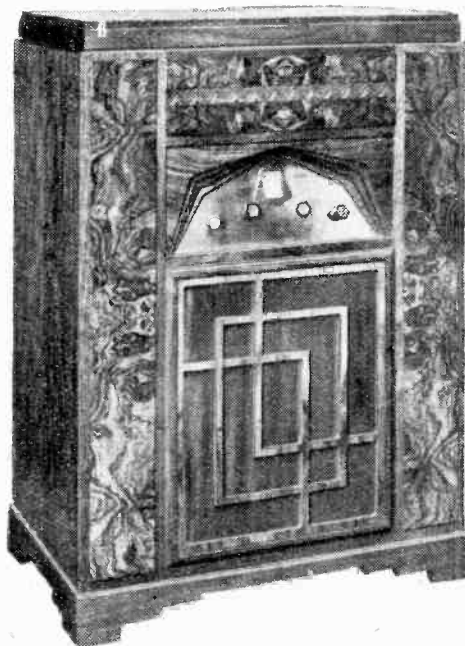

The 12-valve R.G.D. Model 1201A includes a high-quality paraphase type of L.F. amplifier and dual speakers.

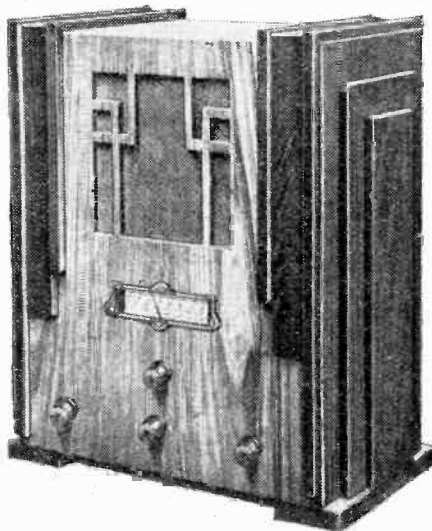

Edge Radio Model MS5.

two-valve frequency changer is employed and the I.F. couplings are the new iron-core type band-pass transformers.

The Marconiphone seven-valve model is fitted with variable-mu valves for the H.F., first detector, and I.F. stages, and Q.A.V.C. is obtained through the combination of valves and metal rectifiers. It is claimed that the output is substantially constant for a 400-1 variation of the signal input.

The Cromwell SH8B has no fewer than eight valves, arranged as an H.F. stage, first detector, oscillator, I.F. stage, diode rectifiers, providing A.V.C., driver, and

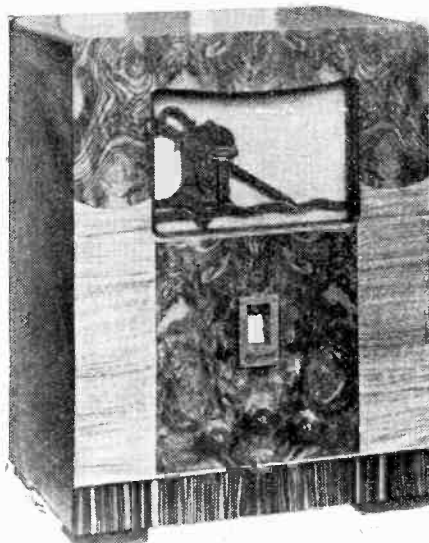

The Cromwell Model SH8A, with Q.A.V.C. and a 3½-watt output stage.

single-diode-tetrode; in all eight valves are used, and the 5½ watts output stage is of the push-pull pentode type.

In the Radio Gramophone Development model 1201 A a double-diode-triode is used with a separate triode for Q.A.V.C., and the A.V.C. system controls the variable-mu H.F., first detector, and I.F. valves. A separate oscillator is employed with a paraphase L.F. amplifier giving 6 watts output to dual type moving-coil speakers. The Tannoy Super Radiogramophone is of the seven valve type, and is unusual in that a pentode is used for the oscillator in order to obtain a high

their 8-valve model is fitted with amplified quiet A.V.C., while the Lissen 6-valve set has a form of pentode amplified automatic volume control.

The Westector is not without its adherents, however, and it is employed to give A.V.C. in the Pye model P/B, and it is also used in several of the Grafton models. The model 808 of this firm has a band-pass input circuit to the H.F. valve with a tuned coupling to the first detector, thus giving a total of three signal frequency tuned circuits and keeping second channel interference at a minimum. Metal rectifiers are used for the second detector and to provide delayed automatic volume control, and there are two L.F. stages. A

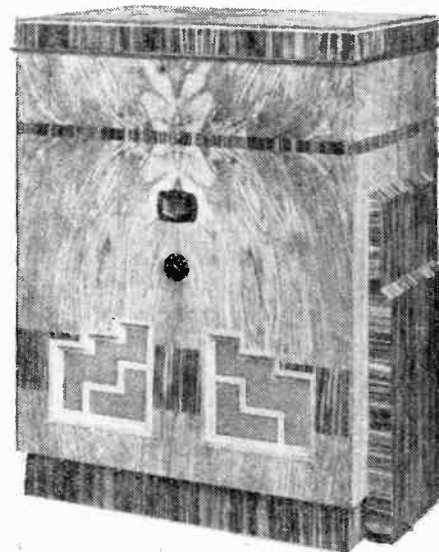

Brunswick eight-valve receiver includes amplified quiet automatic volume control.

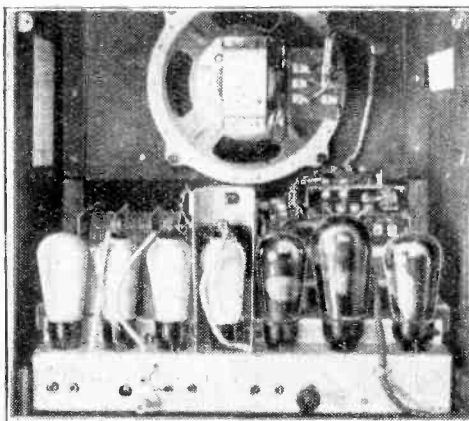

Chassis of the H.M.V. Concert Seven. This set is fitted with D.A.V.C., a static suppressor and a threshold sensitivity control.

Class "B" output. The model SH8A of the same firm is for A.C. mains and is fitted with Q.A.V.C.

It will thus be seen that the general trend of development as exemplified by the exhibits at Olympia may be summed up under the two headings—detector-oscillators and A.V.C. systems. The first of these has brought the superheterodyne and its inherent high selectivity in direct

Progress in Receiver Design—

competition with the moderate size straight set, while the second has greatly extended the usefulness and improved the operation of the larger class of superheterodyne.

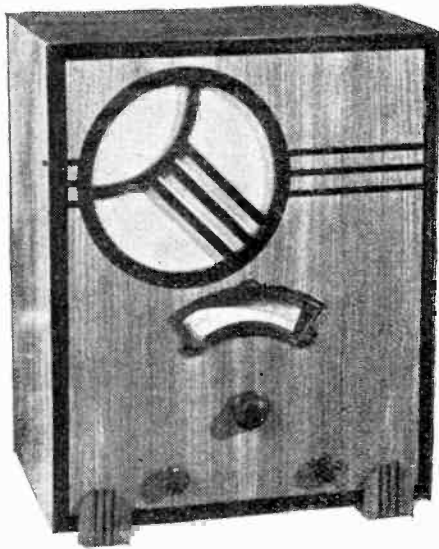

The Hustler, Simpson and Webb "Falcon" model is a battery set with a detector-oscillator and Class "B" output stage.

Straight Sets

Among receivers which do not employ the superheterodyne principle, the three-stage general-purpose set, comprising a single screen-grid H.F. stage, a detector, and a power output valve, is still the predominant type. When designed for A.C. mains it is often described as a four-valve set, but as the rectifier valve is really only

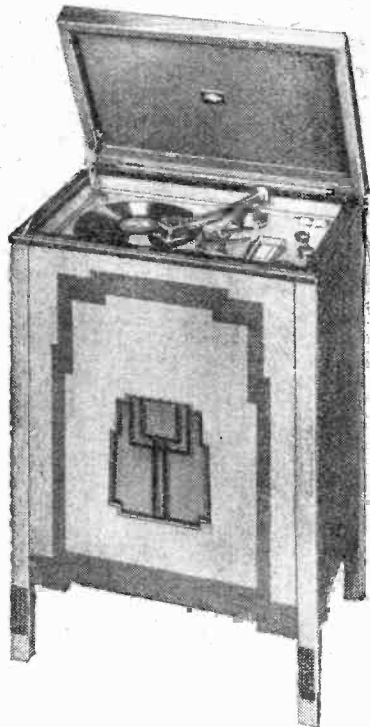

The Marconiphone Model 271 radio-gramophone employs an up-to-date screen grid-H.F.-detector-pentode circuit.

an extension of the mains supply system to provide the anode current in a suitable form, we prefer to describe sets of this type as three-stage receivers.

No epoch-making technical discovery has provided publicity for the three-stage set, but the fact that attention has been diverted to other developments does not necessarily imply that it has become a back number. Improvements in manufacturing methods have resulted in a very acceptable reduction in price, and performance has been improved by detail refinements such as iron-cored coils, as used in the R.I. "Madrigal" receiver. It is safe to prophesy that the H.F.-Det.-L.F. set will continue to satisfy the demands of the average listener who requires good quality reception of the local station with sufficient range and selectivity to enable him to tune in the pick of the foreign broadcast programmes.

We are also able to record a revival of interest in the simple Det.-L.F. type of set, and here again the adoption of the Ferrocart type of coil has enhanced the standard of performance which may be expected from this circuit.

It must not be thought, however, that the scope of the straight receiver has been restricted to the production of general-purpose receivers alone, or that the field of long-range reception with superlative selectivity has been entirely conceded to the superheterodyne receiver. The superheterodyne owes its popularity with

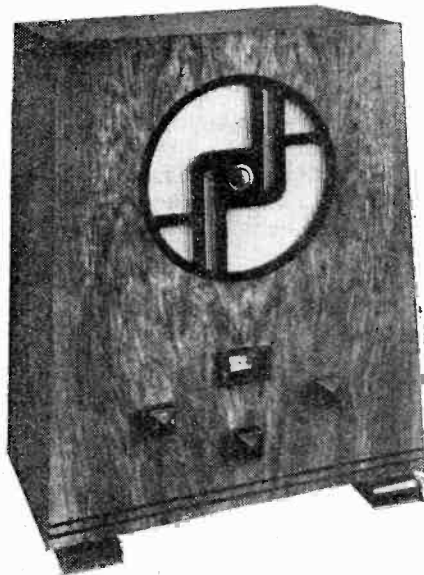

Burgoyne "Olympic 3" detector-L.F. receiver.

manufacturers and the buying public to the fact that it is easier and, generally speaking, less expensive to achieve the requisite degree of amplification and selectivity in an I.F. stage which is required to work at a comparatively low single frequency; but the success which has been achieved has been to a certain extent offset by interference problems due to second channel and I.F. interference generated in the receiver itself.

Two H.F. Sets

The case for the straight H.F. receiver, in which the whole of the amplification prior to detection is carried out at signal frequency, rests on the fact that it is free from this particular type of interference.

All who have had experience of handling the straight H.F. type of set are agreed in giving it credit for quiet and gentlemanly behaviour.

The difficulties of approaching superheterodyne performance with direct H.F. amplification are, however, formidable. Selectivity is directly bound up with the number and efficiency of the tuned circuits, and any attempt to increase either of these quantities in a straight set is attended by difficulties of alignment and stability, not to mention the question of ensuring reasonably constant amplification over the wave range.

The new H.F.-pentode type of screen grid valve has considerably eased the difficulties of the designer in the matter of

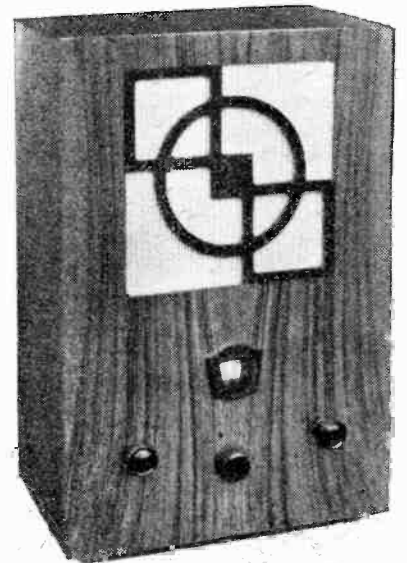

The Lampex "Phantom Minx"—another example of the inexpensive detector-L.F. set.

stability of the H.F. stages, and has also enabled him to provide for a wider range of volume control by means of variation of the grid bias.

Circuit Stability

Another solution of the problem of working two successive stages of H.F. amplification with stability has been to tune the first stage and to make the second stage semi-aperiodic. By arranging that the natural resonance of the H.F. choke in the anode circuit of the second stage shall occur just above the longest wavelength of each wave-range, this scheme can be made to even out the amplification over the tuning scale. An example of this practice is to be found in the McMichael "Lodex Five," in which a patented form of double resonant choke is employed. The Philips Type 834 is another receiver employing one tuned and one aperiodic H.F. stage. In general, sets of this type can be relied upon to give a performance intermediate between that of the three-stage general-purpose set and the low-priced superheterodyne, and this without having to resort to the use of reaction.

To achieve superheterodyne range both H.F. stages must be tuned, and at least three or four tuned circuits must be included if comparable selectivity is to be

Progress in Receiver Design—

obtained. Since these circuits are functioning at signal frequencies, the tuning coils employed must be of exceptionally high efficiency if they are to compete with I.F. amplifiers in which the simplest coils, on account of the comparatively low frequency of operation, give a high degree of selectivity. Assuming that circuits of sufficiently high selectivity could be devised, there is still the difficulty of ganging, which becomes increasingly acute as the sharpness of the resonance curve is increased. These difficulties largely fall to the lot of the works designer, but there are many sets in production to-day which prove that they are by no means insuperable.

In the latest Philips Model 636A we have a good example of straight receiver design with a performance comparable with that of the modern superhet., even to the inclusion of silent automatic volume control. There are no fewer than seven stages of amplification, the first two of which are at radio frequency. In all, there are four tuned circuits associated with the H.F. stages, and all are of the "Super-inductance" type employing Litz-wound coils on glass formers. Two of the tuned circuits are coupled together in the aerial circuit to form a band-pass filter, and the

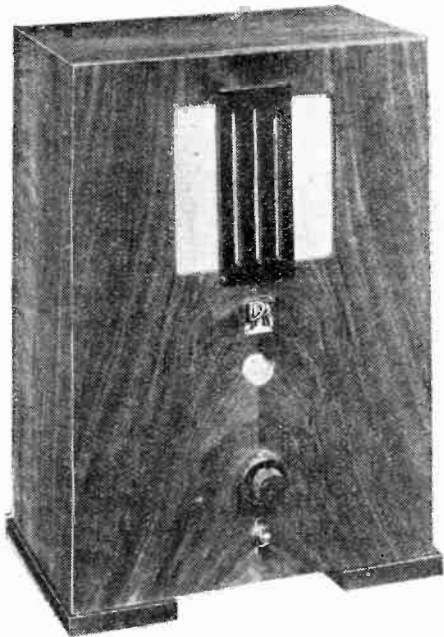

Slektun "R & R Class B Three" in which a reacting detector is followed by a driver and a Class "B" stage.

others take the form of H.F. transformers which are deliberately detuned off resonance by a calculated amount to supplement the function of the input band-pass filter in maintaining high-note response. The high degree of accuracy in ganging which is called for by these circuits has been achieved by a special type of tuning condenser, and, to ensure that the station settings correspond with the calibration chart provided with the set, the slow-motion drive is coupled to the main condenser spindle by a linked drive which can be adjusted to compensate for slight discrepancies in different parts of the tuning

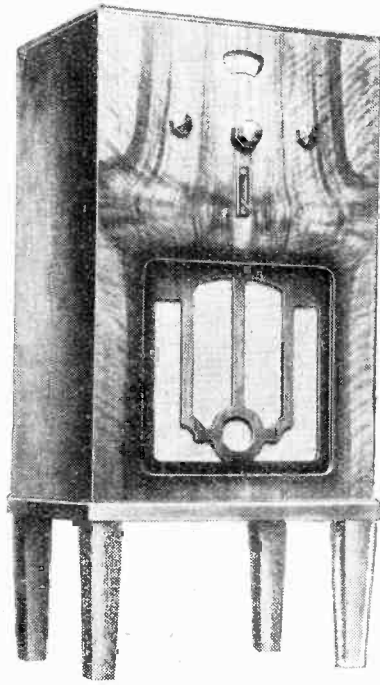

Employing a single H.F. stage and Class "B" output, the Cossor Model 3456 may be used either as a table model or a console.

scale. A screen-grid valve is used in the detector stage proper, and in parallel with this there is a special single diode and screen-grid amplifier valve, the function of which is to provide the bias necessary for automatic volume control. The fifth valve is a triode for the suppression of background noise between stations, and the remaining two stages consist of a high magnification triode L.F. amplifier and a seven-watt output pentode.

Uniform amplification over the wave-range is achieved by a potentiometer coupled mechanically to the main tuning control. This potentiometer gives slight variation of the bias on the second H.F. valve, to compensate for the variation in circuit magnification at different points in the wave-band.

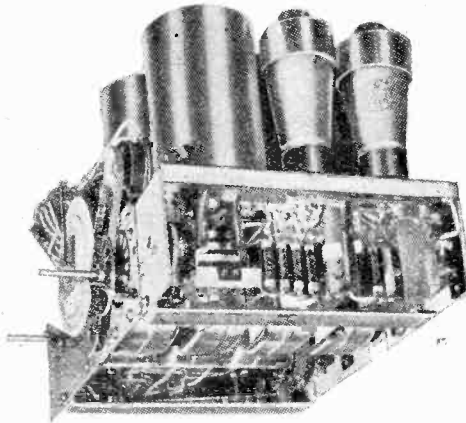

A "straight H.F." receiver of advanced design. The chassis of the Philips Type 636A has seven stages, excluding the rectifier, and is equipped with silent A.V.C.

Automatic volume control is effected in the first H.F. stage, and here the standing bias is also variable in stages to give three levels of over-all sensitivity in order to extract the best possible performance permitted by local conditions.

Amongst other notable examples of receivers in which both H.F. stages are tuned and in which three or more ganged circuits are employed, may be mentioned the Cossor Type 735, the Kolster Brandes Model 320, and the Grafton No. 909 five-valve battery set, which incorporates a Class "B" output stage.

Battery Economy

Mention of Class "B" amplification brings us to the subject of the battery set in general, in which there has been a remarkable revival of interest following the adoption of special output circuits designed to economise H. T. battery power. A move in this direction was made last year by the introduction of high-efficiency battery pentodes, examples of which are still to be found in such sets as the Atlas "Lambda." There was also a special type of circuit in which the H.T. supply was controlled by a separate valve during periods when the transmitting station was not modulated. During the year the quiescent type of push-

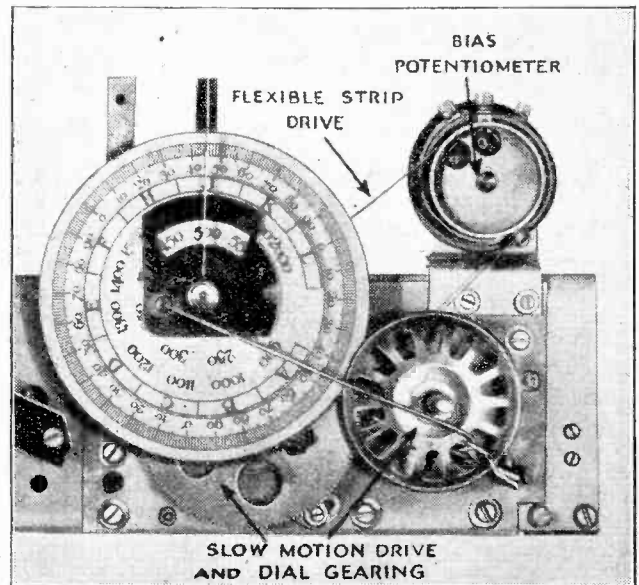

Tuning control and mechanically coupled compensating potentiometer in the Philips 636A giving constant amplification over the wave range.

pull circuit, in which we may include both Q.P.P. and Class "B," has become thoroughly established. The controversy as to which is the more efficient of these two methods is still an open one, and although numerically Class "B" output stages are in the ascendant, the issue from a technical standpoint is by no means settled.

It has been argued that the Q.P.P. system calls for a grid bias battery and extra H.T. current for the auxiliary electrodes of the pentode valves, neither of which are required in Class "B" amplification. It is frequently overlooked, however, that the expenditure of power in the grid cir-

Progress in Receiver Design—

cuit of a Class "B" amplifier calls for a driver stage, which may easily consume as much current as the pentode grids and which also requires adequate bias.



The Marconiphone Model 283 is typical of the inexpensive S.G. - detector - pentode battery receiver.

In push-pull sets of all types accurate matching of the two sections is important. In Class "B" valves, in which both groups of electrodes are enclosed in a single glass envelope, this point can be safely left to the care of the manufacturer, but in the case of Q.P.P., where two separate pentodes are employed, there is the possibility of trouble arising if the purchaser should replace one of the valves without due care. To overcome this possibility the Marconiphone Company in their Model 260 receiver has introduced what they term

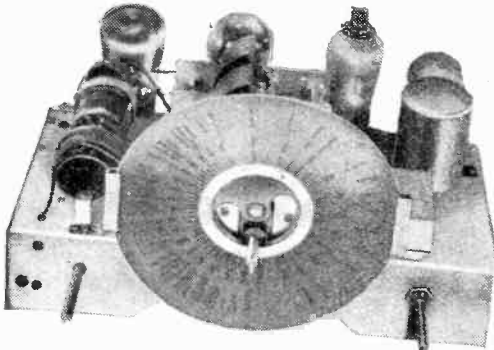

Chassis of the Columbia C.Q.A.4 in which a modified form of Q.P.P. is used in the output stage.

the "Parallel Conductance Principle" (P.C.P.), the essence of which is to ensure that the user shall be in a position to adjust the slope of any replacement valves to the standard value for which the set has been designed. In future all pentodes supplied for this set will be divided into five classes, each marked with a distinguishing letter. Suitable tapings in the H.T. battery will be lettered to correspond with each of the five classes of valve, so that by inserting the auxiliary grid lead in the socket corresponding with the letter marked on the valve the slope of the valve will be automatically adjusted to the standard value. In other words, the slopes of the valves, upon which the mutual conductance depends, will be made parallel.

A similar system has been adopted in the Columbia "C.Q.A. Four" set, and, due to the care which has been taken in adjusting the curvature of the foot of the valve characteristic and the correct application of the working point, i.e., the point where the slope is exactly half the slope of the straight portion of the curve, freedom from distortion has been ensured at all output levels. It is for this reason that the system has been named "Constant Quality Amplification" (C.Q.A.).

The Battery Radiogram

The introduction of economical output stages has been the means of stimulating the development of the battery radiogramophone. Hitherto it has been difficult to produce an output reasonably in

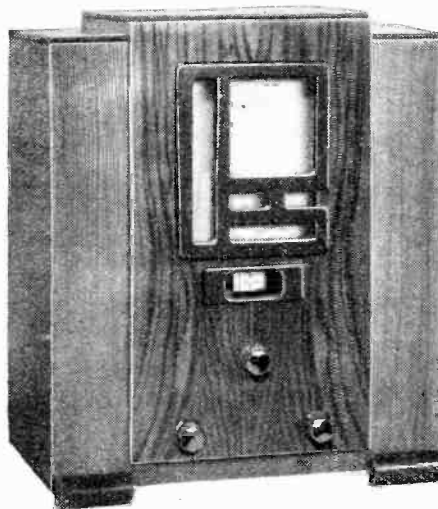

Quiescent push-pull pentodes are used in the output stage of the Bush Radio 5-valve battery receiver.

keeping with the size of the average radio-gramophone cabinet without considerably increasing the maintenance costs of a battery-energised receiver. The quiescent output stage has definitely removed this difficulty, and

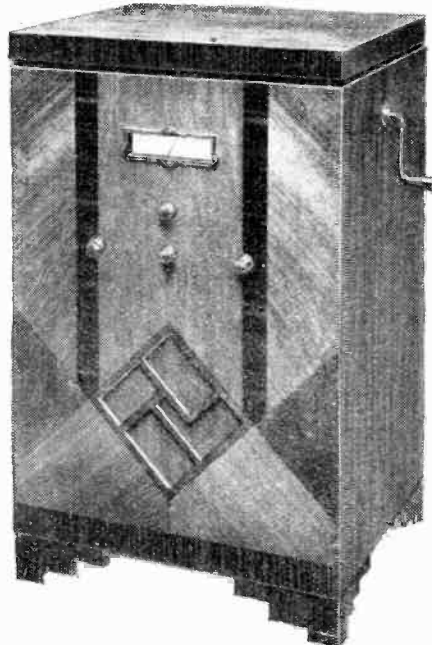

A typical example of the new battery radiogramophones—the Edge Radio Model RB4.

we may reasonably expect to see an increasing number of sets of this type during the coming season. A clockwork

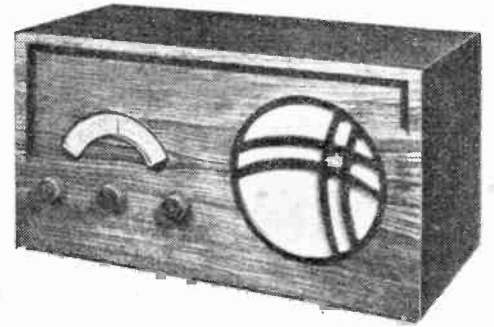

The tendency towards "horizontal" type cabinets is exemplified in the Atlas B4 battery receiver.

motor is, of course, employed, and the Columbia "C.Q.A. Radiograph" may be taken as representative of the Q.P.P. system and the "Alba" Battery Radiogramophone of the Class "B" output valve.

Cabinet Design

With regard to the cabinet design, there is a noticeable tendency towards the horizontal type of cabinet in which the loud speaker is placed on the same level as the tuning controls. In many cases transportable sets of this type are provided with a separate pedestal as in the case of the Climax D.C.3.

The McMichael "Twin Supervox" cabinet is also of the horizontal type, and

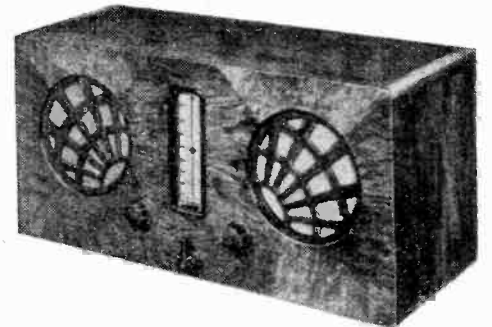

Dual loud speaker units are fitted in the McMichael "Twin Supervox" table model.

is probably unique in representing the application of dual loud speakers to table model sets. Although we have not yet reached the stage of true "stereophonic" reception, which would necessitate twin microphones and transmitters, in addition to dual loud speakers at the receiving end, there can be no doubt that two loud speakers carefully placed not only give a better overall frequency response, but also give a subtle difference in quality which is a distinct improvement on the comparatively "flat" tone of a single unit.

The New Portables

It required no great stretch of imagination to foretell that many of the self-contained battery sets for the coming season would make full use of the battery-economy systems that have been developed during the past year. Here reference is

Progress in Receiver Design—

made, of course, to those systems, such as Class "B" and Q.P.P., in which drastic economies are effected by the logical principle of limiting output anode current to the value required for dealing with the strength of signals actually being received.

Among the sets to include Class "B" amplification is the Portadyne P.B. Model, which embodies a "straight" circuit with manual tone control and a moving-coil loud speaker. Another somewhat similar set is the Lissen Class "B" Portable, in which a combined reaction-volume control is fitted.

The use of Class "B" amplification is not confined to straight portable sets, and is to be found in the new Pye super-

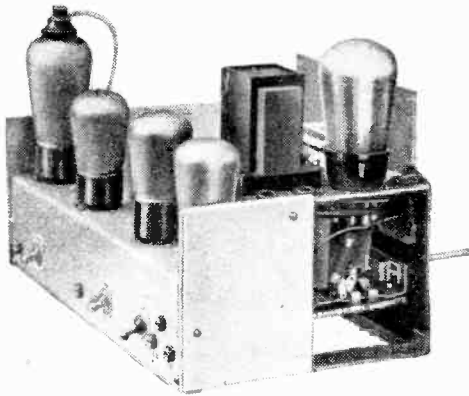

Portadyne Model P.B. chassis.

heterodyne portable, the output stage of which is rated at 1.4 watts. This set is a transportable rather than a portable, and is fitted with a moving-coil loud speaker. In its class it is certainly one of the most interesting of the new sets, if only for the reason that a Westector second detector provides delayed automatic volume control.

In spite of the claims of Class "B" and Q.P.P., a number of portable sets make use of high-efficiency pentode valves; in this category come the portable superheterodynes shown by Marconiphone,

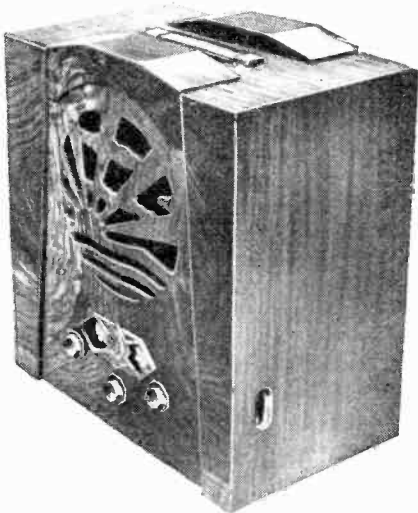

Pye portable superheterodyne.

Columbia, and H.M.V. Similarly, many straight portable sets embody the same output arrangement; amongst these are the well-known McMichael Duplex Four,

the Beethoven Major Model, and the Aerodyne Eagle. It is interesting to observe that these sets, in addition to several others, use the well-ried combina-



The new Beethoven Major portable.

tion of one tuned H.F. stage, a grid detector, and two L.F. stages.

The practice of fitting permanent-magnet moving-coil loud speakers in portables represents a new trend in design; actually, a great number of the heavier "transportables", are so equipped, but only one or two "suitcase" portables (for

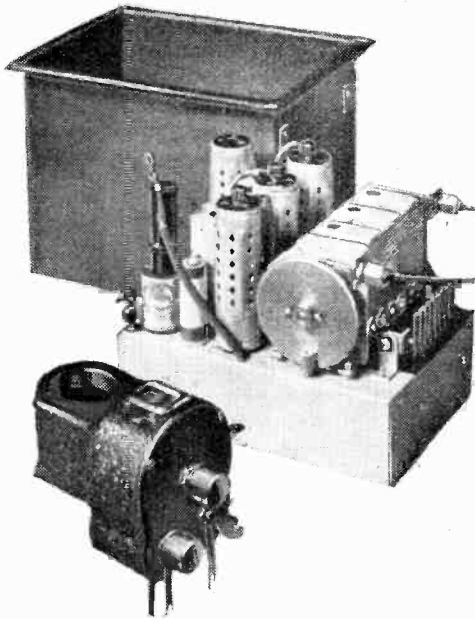

Page Car Radio set, with weatherproof case and remote control unit.

example, the new McMichael and the Beethoven) are fitted with this type of loud speaker.

Iron-cored tuning coils, which offer special advantages in a portable, are not so widely used as might be expected, but are to be found in one or two examples.

Finally, there are a range of exceptionally small Adey portables, stated not to exceed thirteen pounds in weight. The same firm make use of a "self-coupling valve" in their standard models.

All this season's portables seem to represent extremely good value for money: as an example of one of the cheapest, mention may be made of the Shalless and Evans Embassy Model, with a 1-v-2 circuit and a Celestion loud

speaker, which is sold at seven guineas complete.

The introduction of an entirely new type of set, so far as this country is concerned, is to be recorded. This is the motor car receiver, intended to be installed permanently in a car, and to operate while the vehicle is stationary or in motion. For good results, such a set must obviously be highly sensitive, due to the limited pick-up of even the best aerial that can ever be installed; and further, an effective form of automatic volume control is desirable in order to compensate for the normally severe fluctuations of signal strength.

These requirements are met by the Page Car Radio superheterodyne, which is the only car set of which details are yet available. A five-valve superheterodyne circuit is employed, with a signal-frequency H.F. stage and a combined oscillator-de-

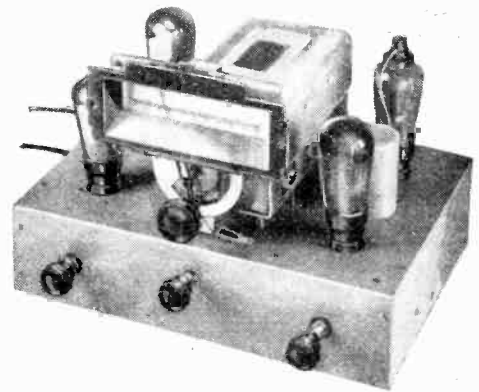

Haynes Radio Class "B" Four.

tor; naturally enough, unbreakable Catkin valves are employed throughout.

Kit Set Tendencies

Although there are fewer receivers available this year as kits of parts, the prospective constructor has still a wide choice, the sets shown ranging from simple "straight" circuits to superheterodynes of the most ambitious type.

Cossor Melody Makers are produced in several models, but all are cleverly designed for mounting on the same steel chassis, and include a straightforward H.F.-det.-L.F. circuit with two tuned circuits. It is interesting to note that centre-tapped tuning coils are employed both for the aerial-grid coupling and the tuned anode H.F. coupling, matters being so arranged that the medium-wave windings are divided electrically into two sections, the long-wave loading coils being inserted at the centre point, à la Hartley circuit. An anti-break-through choke is inserted in the aerial circuit to prevent medium-wave interference on the long-wave band. The Cossor battery models include a kit with pentode output, and another with Class "B." A mains-driven version, with an energised moving-coil loud speaker, is also available.

Lissen kits are even more than usually interesting from the technical point of view. The "Universal Skyscraper Q.P.P." four-valve battery-fed set, which costs only £5 12s. 6d. with valves, covers wavelengths between 12-2,000 metres in four ranges, the change-over being effected

Progress in Receiver Design—

by switching in the modern manner. An H.F. stage is included, and the detector is a screen-grid valve.

In spite of its "all-wave" feature, this set seems quite easy to build. Special cabinets, both of the table and console types (the latter with a moving-coil speaker) are available for it.

The Lissen superheterodyne kit is equally interesting and even more ambitious. This is a seven-valve set for battery feed, including amplified automatic volume control, Class "B" amplification, and tone control.

Although they are available as finished receivers as well as kits, the exhibits of Haynes Radio will be treated here. Modern tendencies in design are illustrated by the fact that all sets include Ferrocart coils, and all except those of the battery type are arranged in two units. In every case, two- or six-watt amplifier units can be supplied. The sets include the Class "B" Three, a det.-L.F. combination; a similar four-valve battery set with H.F. amplification, and the well-known A.C. Quality Four, which now appears in slightly modified form, with the latest Ferrocart coils and a variable-mu H.F. pentode. Among other Haynes' sets are A.C. and D.C. superheterodynes with Pentagrid or two-valve frequency changers and amplified delayed A.V.C. These are claimed to be the first all-iron-cored superheterodynes.

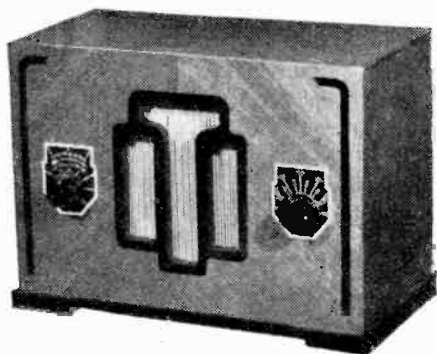

A British "Midget" set, the Sunbeam Model M30.

We may draw attention to the fact that kits of parts for several *Wireless World* sets are displayed by C.A.C. Lastly, Westinghouse are sponsoring a superheterodyne kit which illustrates the use of the Westector H.F. rectifier.

Universal A.C.-D.C. Sets

There is no technical reason nowadays why a set designed to work interchangeably on A.C. or D.C. mains should not give excellent results, and several manufacturers have produced models of this type, which represent yet another new tendency.

Indeed, two distinct novelties are embodied in the Sunbeam M.30 set, the first British version of the American "midget" set which has been so successful in the country of its origin. An A.C.-D.C. circuit is employed, in which the heaters of

both receiving and rectifying valves are connected in series and joined directly to the mains through a voltage-reducing resistance. An H.F.-det.-L.F. three-valve arrangement is employed, and the set measures only 11 in. in width and 8 in. high. Several other "universal" Sunbeam sets, of more conventional dimensions but with the same basic circuit, are produced.

The Cromwell "A.C.-D.C." employs three 16-volt valves in a straight circuit with pentode output; the cabinet is of the latest horizontal pattern with a permanent-magnet moving-coil loud speaker mounted at the side of the receiver chassis. In the Grafton Universal model, another H.F.-

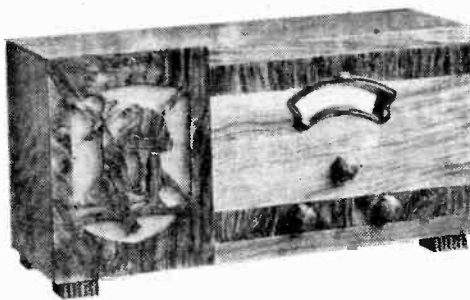

The Cromwell A.C. D.C. "Universal" set.

det.-L.F. set, the present-day tendency to adjust the filter coupling for optimum transference of energy, rather than to cover a band of frequencies, is exemplified; this is described as "peak band pass," and suitable precautions are taken elsewhere to avoid high-note loss in the tuned circuits.

The new "universal mains" idea is not confined to straight sets, but has been applied, apparently with complete success, to several superheterodynes, including another Grafton model. In the Higgs Super-C, a six-valve superheterodyne circuit is employed, with a pentode passing its output of 1,750 milliwatts to a Magna moving-coil loud speaker.

Unclassified Apparatus

Commercialised television is making progress, and two complete vision receivers are exhibited at Olympia. The Bush Radio equipment, made for the Baird Television Company, was illustrated last week; it includes a receiver unit comprising one H.F. stage, a detector, and a four-stage resistance-coupled L.F. amplifier. The mirror drum system is employed, and a loud speaker is fitted; this may be connected to another set for simultaneous sound reproduction, or to the built-in amplifier for operation as a normal receiver. The price is 50 guineas. We have already had an opportunity of handling this equipment, which is quite practical and easy to work.

The second television set, made by Grafton, embodies two separate receivers,

one for sound and the other for vision. The first is a straightforward H.F.-det.-L.F. three-valve combination with band-pass tuning and pentode output, while the

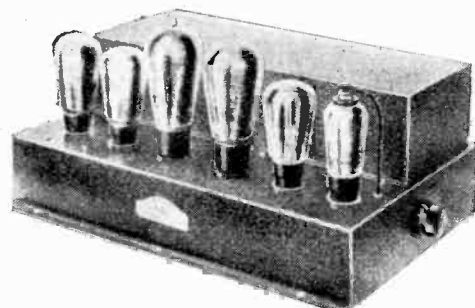

The B.S.R. 15-watt amplifier.

second includes two H.F. stages, diode detection, and a special amplifier. Of course, the "sound" receiver may be used separately.

With regard to L.F. amplifiers, the introduction of resistance-coupled push-pull by R.G.D. may revive an old controversy. Resistance coupling, with its faithful reproduction of transients, has many devotees, and, in its new form (which we believe has not previously been available commercially) offers additional advantages.

General-purpose amplifiers are shown by an increasing number of manufacturers, and it is clear that special attention is being paid to public-address apparatus. For this purpose, the compact equipment, complete with moving-coil microphone and long-range loud

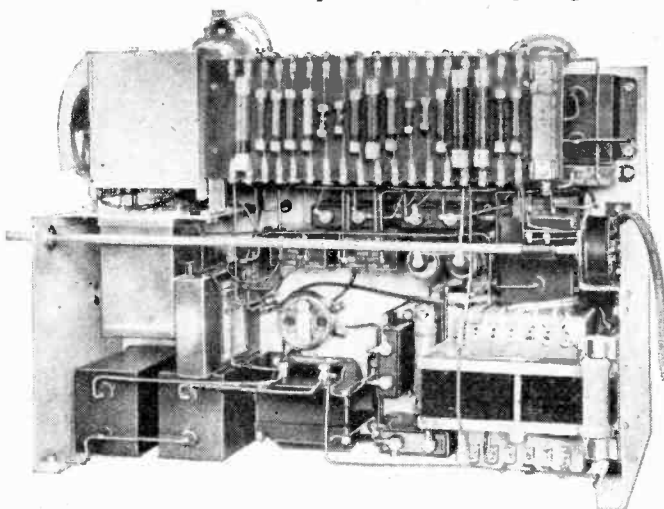

Bush Radio television amplifier.

speaker, shown by Film Industries is interesting. In addition to the amplifiers dealt with in our Show Forecast, mention should be made of two representative types made by Tannoy, in which outputs of about 15 and 30 watts are obtained from respectively one and two DA.60 valves.

A "non-radio" innovation of considerable interest has been introduced by Multitone, who are showing a Class "B" 2-H.F. set which functions (a) as an ordinary broadcast set, (b) as the same, but with a "parallel" output with independent volume control for headphone listening by a deaf person, (c) as a deaf-aid amplifier, for which purpose the special loud speaker is converted into a microphone.

PENTODE OR TRIODE?

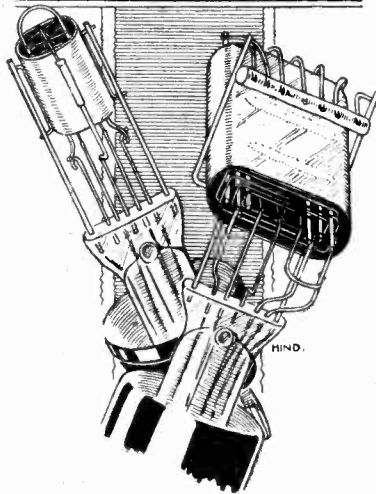

WHY are pentodes ever used? They are more complicated than triodes, and hence are more easily damaged; they are more difficult to harness to the loud speaker; there is a strong tendency for them to give poorer quality of reproduction; extra components are almost invariably required to prevent excessive shrillness; an extra H.T. tapping has often to be found; and—important in these days—they appear to cost a good deal more.

Since pentodes actually are used in vast quantities, it is obvious that they have something substantial to offer that overrides this impressive array of objections. They offer two advantages—greater sensitivity and greater efficiency. As these words, and particularly efficiency, are commonly used in a loose and indefinite sense (e.g., “—’s Boot Polish is the most Efficient in the World”), it is important to understand that here they are to be taken as exact scientific terms, so before going farther it will be as well to explain them.

The object of an output-stage valve is to deliver a certain amount of power to the loud speaker; enough to produce as much sound as we want without distortion. For the valve to function, it is necessary to supply it, among other things, with a continuous flow of current to the anode (“H.T.”), and a varying or “signal” voltage to the grid.

Sensitivity

The sensitivity tells us how little signal voltage is necessary to make the valve furnish its quota of power, and the efficiency indicates how little H.T. is required for the same purpose.

Sensitivity is measured in milliwatts (unit of power) per grid volt squared, written mW/V_g^2 . The grid voltage, which, let it be emphasised, is the signal voltage and not grid bias, is squared because the power is proportional to the square of

A Comparison of Their Merits

OPINION is more or less divided upon the question of the choice between a triode or pentode valve in the output stage. In this article the author compares the two from the standpoints of sensitivity and efficiency.

By M. G. SCROGGIE, B.Sc.,
A.M.I.E.E.

the signal voltage. For example, if a valve which is adjusted to the most favourable working conditions delivers 1,000 milliwatts when the intervalve transformer or other coupling connecting it to the previous valve is giving it 10 volts, then the sensitivity is $1,000/10^2 = 10$. It is substantially correct to go on to say that if the signal is 1 volt the power output is 10 milliwatts. But it is not necessarily correct to suppose that if the signal is 20 volts the output will be 4,000 milliwatts, because that may exceed the limit of which the valve is capable. If we are offered the choice of two valves, each of which gives the required power, then the one with the greater sensitivity is the one that requires the less voltage from the previous valve. So it may be possible by selecting it to work with a resistance coupling instead of a more expensive transformer, or even to cut out a whole stage between it and the detector. On the other hand, we may not be at all pressed for signal volts, and then the more sensitive valve has little advantage.

Efficiency is expressed as a simple percentage because the H.T. power is also measured in milliwatts, so this is a very easy calculation. For example, a 500 milliwatt output valve requires 10 milli-

amps at 200 volts. The input is therefore $10 \times 200 = 2,000$ milliwatts, and the efficiency is $500/2,000$, or 25 per cent. The importance we attach to efficiency depends on how much we have to pay for power; as battery power costs roughly one pound sterling for every penny charged for a similar helping from the mains, the battery user is likely to look at this matter through a very different pair of spectacles to that worn by the listener who plugs in. The time when the latter gives most thought to the problem is when he is contracting to pay for a new receiver, because the first cost goes up very steeply according to the demands made by the output valve.

Running Costs

If, therefore, the pentode is more efficient, that is, needs less power put into it to get the required amount out, it will cost less to run in a battery-driven set, and will make a mains-driven set less to buy. It may be urged against the latter claim that the pentode itself costs more. But examination of valve data, as published in *Wireless World Valve Supplements*, or *The Wireless World Diary*, brings to light the fact that a pentode costs little or no more than a triode capable of supplying the same output. In fact, in the larger sizes a pentode costs a good deal less. The 10,000 milliwatt pentode is priced at less than half the same maker's 10,000 milliwatt triode. For the usual 2,000 milliwatts a pentode is a shilling or two more than the corresponding triode. Of course, if the output is fixed at a very low figure like 150 milliwatts, the pentode looks rather expensive, because it is not made in sizes limited to such a small output.

Before we can assess the relative merits of the rival types we must know by how much the pentode excels the triode in its twin virtues of sensitivity and efficiency. The accompanying charts are intended to shed light on this question. The vertical

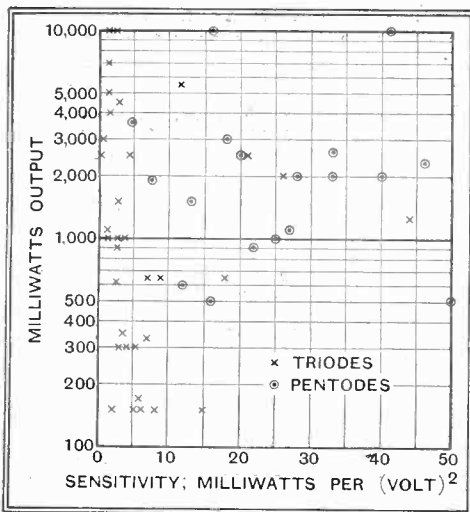

Fig. 1.—Chart to show the relative sensitivity of representative makes of triodes and pentodes.

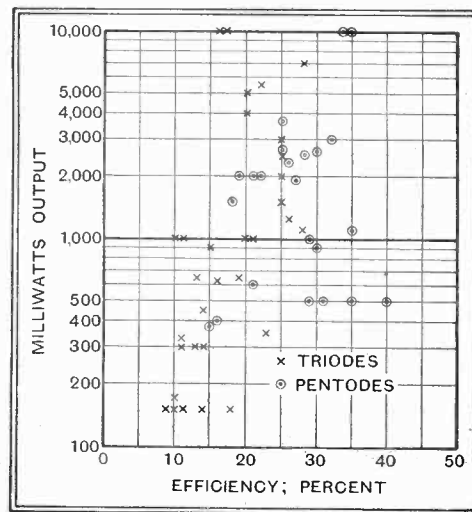

Fig. 2.—Chart showing the relative efficiency of triodes and pentodes.

Pentode or Triode?—

scale in each of them is maximum power output, which we are using as a basis of comparison. It has been made a logarithmic scale merely to spread out the points evenly. The horizontal scales serve for percentage efficiency and mW/V_g^2 respectively. The points indicate these two quantities for both triodes and pentodes listed by four makers whose products are comparable. The rather wide range of variation is perhaps due to the fact that some of these valves might well be placed on the retired list to make way for those more recently developed.

The Final Verdict

Looking at Fig. 1, the sensitivity of triodes is seen to vary enormously from 0.3 to one stray hero on the 44 line. But, disregarding the prodigies, an average would be drawn at about 5. The pentodes also cover a wide field, but their average is more like 25. In other words, the average pentode gives about five times as much output as a triode for a given grid swing. But, as we are judging them on the basis of an equal output, in order to find out what the previous stage has to do, the same thing is better expressed by saying that the triode requires rather more than double the signal voltage applied to the grid to drive it at full throttle (actually $\sqrt{25/5}=2.24$ times as much if those averages are assumed).

So the sensitivity of the pentode, which was acclaimed in the early days as equal to an extra stage of amplification, is actually of little account. There is seldom such a shortage of volts from the detector that an intermediate stage is necessary even with a triode, and, as we have seen, an exceptional triode will compare with any pentode on this score.

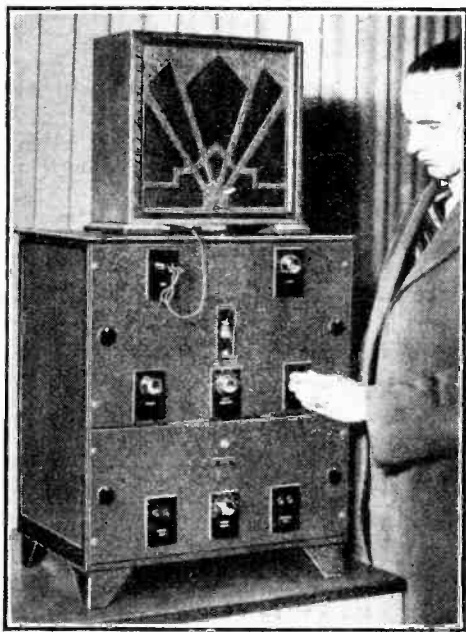

Marconiphone apparatus for broadcast reception recently installed at the Stanmore Orthopaedic Hospital. The apparatus consists of a superhet. receiver coupled to a P.23 amplifier.

How about efficiency? The first glance at Fig. 2 finds a tendency for it to increase as the power rating of the valve increases. That is not at all surprising. It applies to most types of machines, and is one reason why lots of little electric power stations are being scrapped in favour of a few "super" stations. So our conclusions depend to some extent on whether our interests lie in the 150 milliwatt class or the 10,000 milliwatt class—or somewhere in between.

Fortunately for comparison, efficiency does not fluctuate so wildly as sensitivity, and there is not much difficulty in assigning an average of about 30 per cent. to the pentode. As the object is to compare the drain on the H.T. supply, the current taken by the auxiliary grid (which is often forgotten) is included in this calculation.

The triode efficiency is more difficult to express in a single figure. In the lowest power classes, where there is no competition, it is round about 12 per cent. Else-

where the average may be put at 20 per cent. Which means that from 800 milliwatts upwards the triodes require something like 50 per cent. more H.T. to handle the same amount of output as a pentode.

That may signify very little or a great deal, according to circumstances. Though there are no pentodes limited to two or three hundred milliwatts, they can, of course, be operated with reduced H.T. for economical working in portable and other battery sets, and the efficiency is well maintained, whereas the competing triode falls off rather badly, as we have seen. The advantage is then more like 100 per cent. in favour of the pentode. At the same time, not only is the efficiency maintained, but so also is the price, which likewise is about double that of the triode.

It is now merely a matter of "Consider your verdict, gentlemen," but, to prevent a deadlock, it will be necessary to have two jury-boxes, one for battery and one for the mains.

DISTANT RECEPTION NOTES

Illicit Stations of Europe

FROM time to time we read in the lay papers startling accounts of the activities of some "mystery" broadcasting station. I wonder how many readers of *The Wireless World* have any idea of the number of unknown stations which are constantly at work within the limits of the medium waveband. If you examine any of the monthly reports of the U.I.R. you will be surprised to find how many transmissions there are marked not with a name but with a query.

In the great majority of cases this does not mean that a transmission came from some authorised but unidentified station. The department of the Brussels Laboratories which is responsible for wavelength-checking knows the stations of Europe so well that it could hardly fail to identify any of them, even if it were considerably off its normal wavelength. In most instances the queries denote stations of unknown origin which, though they have no right to be working on the medium waveband, do so night after night and often with considerable power behind their signals.

The last U.I.R. report shows no fewer than a score of such stations, and there is no question that many of them are responsible for heterodyne interference with authorised transmissions. The position is a rather disquieting one, for the presence of such a number of illicit stations on the medium waveband is already something more than a nuisance, and if they are allowed to continue at work they may suffice to upset the delicate balance of the Lucerne Plan.

Another problem of no small dimensions is that provided by the harmonics of some of the bigger stations. Many of the more powerful long-wave stations have third, fourth, and fifth harmonics, which assert themselves in the wave-band between 200 and 550 metres. But it is not only the long-wave stations that may interfere; any medium-wave station with a wavelength about 400 metres can cause trouble if it develops a strong second harmonic. The harmonic question is one that will probably demand much attention in the future.

Readers may have noticed that there is a tendency among Continental stations to give their call-signs less and less frequently. This is rather trying unless the set is accurately calibrated, and calibration itself becomes, of course, a much slower and more laborious business. Many stations have adopted distinctive interval signals, but it is quite a feat to memorise these. If you are engaged in calibrating, and cannot identify certain stations, one of the most fruitful methods is to make a note of the various settings, and then to return to them at times between 10 and 11 p.m., when the stations are going to bed. Many close down with their national anthems or with some form of "Good-night." Identification is usually easy by means of the music or the language used.

Germany and Lucerne

Germany, I hear, is going forward rapidly with preparations for the coming into force of the Lucerne Plan. It is quite likely that certain wavelength exchanges between German stations will take place early in the autumn, with a view to letting stations settle down to channels near those which they will occupy after January 15th. Under the Lucerne Plan Stuttgart is to work on 522 metres, Munich on 405.4 metres, and Witzleben on 356.7 metres. The present wavelengths are: Munich 532.9 metres; Witzleben 419 metres, and Stuttgart 360.1 metres. The present proposal is for Witzleben to take over Stuttgart's channel (a change which will be welcomed by the B.B.C.—until Berlin goes up to 100 kilowatts!), Stuttgart will go up to 532.9 metres, and Munich will occupy Witzleben's former channel.

The choice of stations is as wide as ever on both the long and medium wavebands. Were I limited to a dozen Continental transmissions, the twelve that I would choose at present would be: Huizen, Radio-Paris, Warsaw, Prague, Langenberg, Toulouse, Rome, Leipzig, Strasbourg, Brussels No. 2, Breslau, and Trieste.

D. EXER.

SIDELIGHTS ON OLYMPIA

Early Impressions : Better Than Ever

WHERE exhibitions are concerned we have no veneration for the past. It seems the natural and usual thing to belittle all previous exhibitions by describing the affair of the moment as "the finest of its kind ever held, etc." This good-natured habit places one at a disadvantage when the Show under review really is the finest of its kind ever held; so that in

Not so to-day. Although at Olympia the modern note in stand designs "hits one in the eye," it becomes instantly noticeable how ultra-modern in appearance the average set has become, harmonising with the new steel furniture (which fills the Show almost to the point of congestion), but remaining in tune with furniture bought the day before yesterday.



OLYMPIA CALLING. This view of the B.B.C. Theatre at Olympia gives an impression of its great size and the clever lighting effects.

trying to picture Olympia, 1933, the writer gropes for superlatives, finds none that have never been used before, and decides that plain, unadorned English must suffice.

Olympia has never yet offered us a radio show so glitteringly and yet so solidly attractive. As if to atone for the absence of

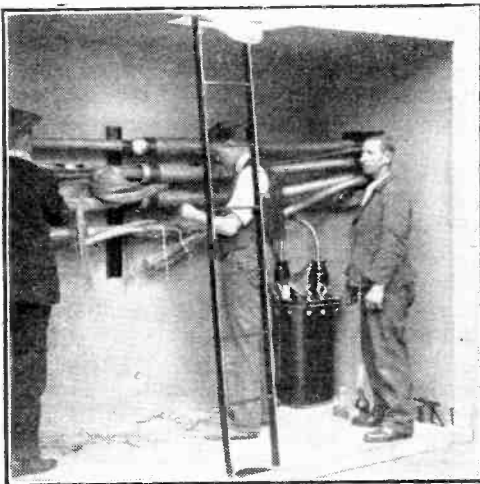

UNDERGROUND. In this model of a typical Post Office cable tunnel the lowest cable is a 159-pair composite incorporating wires used for broadcasting.

individual demonstration rooms, the exhibitors seem to have expended the last ounce of energy in making their stands original and compelling, and in this they have been largely helped by the sane decision of the R.M.A. to permit more individual latitude in the design of stands than in the past.

It was whispered some years ago that stand designs were too attractive; they made the wireless sets look cumbrous and old-fashioned.

small village. Trunk telephone services, the teleprinter, and man-made static are exploited to the uttermost, especially the last-named, and there is diabolical irony in the display of such life-sweetening devices as vacuum cleaners, electric refrigerators, electric sewing-machines and hair-dryers, all capable of producing human misery within earshot of a loud speaker.

Lovers of quality reproduction will be interested in devices for demonstrating visually and aurally the presence or absence of certain bands of frequencies in reproduced music. By the use of switches, different portions of the musical register can be added or suppressed.

At one time the Post Office considered the advisability of showing a "pirate-trapping" outfit, complete with direction finder and rotating aerial, but other counsels prevailed.

The B.B.C. Theatre astonishes one by its vastness. Seating 2,500 people, all of whom get a perfect view of the stage, this gigantic "studio" is as large and comfortable as any suburban cinema, and the acoustics are superior. The B.B.C.'s own exhibit, though not spectacular, will repay close inspection. The coloured photographs of the studios and transmitters are highly effective, while the

One pre-Show rumour must be exploded. Not ninety per cent. of the visitors are women, so no reader should stay away from Olympia on this score. Men are probably in the majority by three to one. Last year the ratio was four to one. Significant!

The two principal "side shows" are the Post Office display and the B.B.C. theatre. Never before has the Post Office taken so much space. This year the P.O. effort is an exhibition in itself, and is the size of a

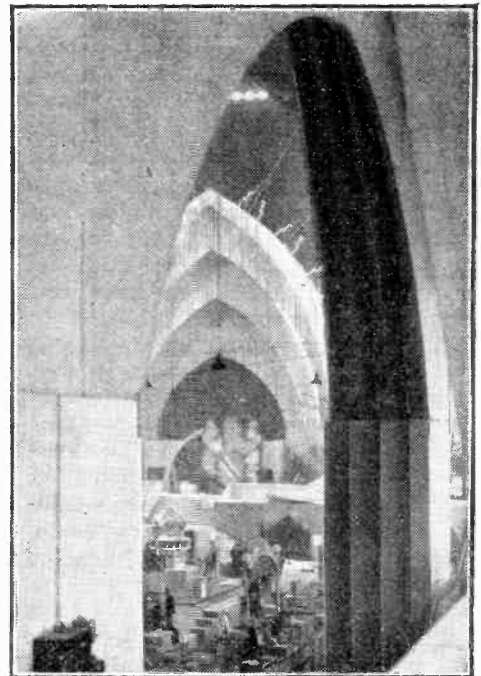

AN ECCLESIASTICAL EFFECT is obtained in this unusual view of the brilliant electrical composition which dominates Olympia.

permanent crowd around a large glass cubicle testifies to the public interest in the 1½-kilowatt amplifier which is flooding all Olympia with a cascade of music.

A Glowing Pageant

The Show abounds in novelties. The most valuable single exhibit is contained in a little iron cage, and consists of a gold and a silver bar to the value of £2,000, representing the amount of these metals used by H.M.V. in a year in producing switch contacts for radio receivers.

Although the Show numbers of *The Wireless World* give a comprehensive view of the exhibition and all that it stands for, the man who stays away from Olympia will have missed a glowing pageant of wireless for which there can be no substitute.



MISCHIEF MAKERS. A section of the G.P.O. exhibit devoted to the cause and cure of man-made static.

Practical HINTS and TIPS

IT is somewhat disturbing to find that a push-pull output stage goes on working quite happily when one of the valves is withdrawn from its holder. Those whose receivers behave in this way may be reassured by the statement that it does

Points About Push-pull

not necessarily indicate that anything is wrong; the accompanying diagram, Fig. 1, shows how this

state of affairs can come about.

In diagram (a) the conventional push-pull output stage is shown, while in diagram (b) the connections belonging to one of the valves have been "faded out." What is left is nothing more nor less than an ordinary single-valve output stage.

Of course, the withdrawal of one valve may be expected to result in a serious diminution of volume and deterioration of quality as well. But, especially in mains-operated sets, volume may not fall off to any very obvious extent; this is because an H.T. voltage rise will take place as a result of removing one valve, and the remaining valve, working in an overloaded condition, may give, at any rate for a while, an abnormally great volume.

A well-known advantage of the push-pull system is that an amplifier in which it is included is less prone than usual to

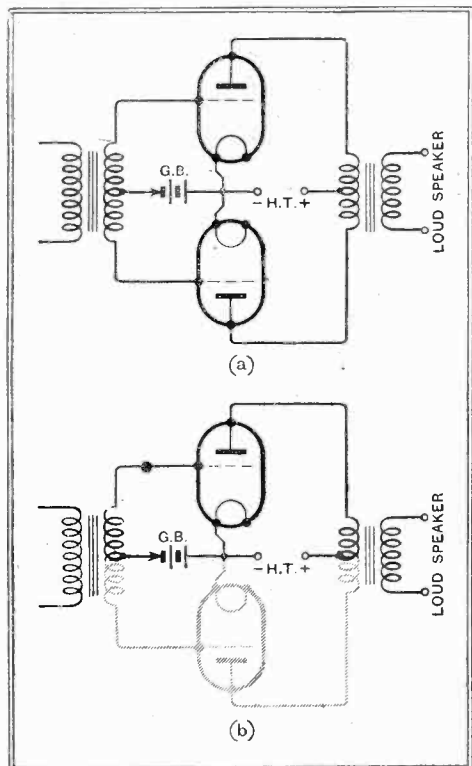
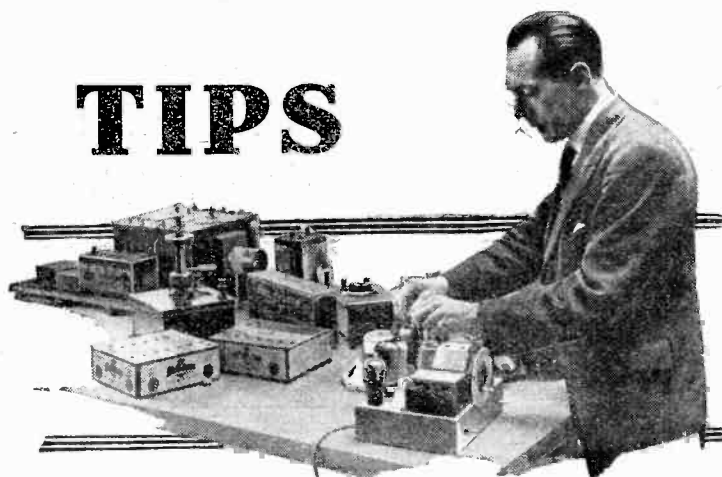

Fig. 1—A conventional push-pull stage, and (b) a diagram to show how it can work with one valve removed.

motor-boating and other forms of instability. It is, therefore, not surprising that in many cases the result of removing

AIDS TO BETTER RECEPTION



one valve is the production of violent motor-boating. Quite often, however, removal of one valve will produce motor-boating, but on replacing this valve and removing the other, fairly normal working will be obtained.

This effect seems puzzling, but there is a fairly simple explanation for it. In one case the phase of the impulses fed back to the earlier stages by the output valve is such that instability is provoked, while in the other there is an anti-reaction effect which prevents self-oscillation.

It follows from this that if motor-boating occurs in a push-pull amplifier one of the output valves may be suspected as being faulty.

Still another point emerges; it is distinctly dangerous to modify a published design in which push-pull is included by the substitution of a single-valve output stage. The amount of decoupling that may be more than sufficient in a push-pull amplifier may be quite inadequate for the changed conditions.

QUITE apart from the ordinary forms of second-channel interference, superheterodynes are liable to suffer from other forms of whistles if the detector is operated in an overloaded condition. These are often due to the production of harmonics of the I.F. amplifier; overloading due to a powerful local station may occur when the set is tuned to a wavelength differing considerably from that of the interfering station, especially if the number of pre-selector tuned circuits be small.

Super-heterodyne Whistles

Further, it should be borne in mind that whistles due to the generation of harmonics are particularly likely to give trouble in a receiver with battery valves, which can never handle so large an input as those of the indirectly heated mains-driven type.

It follows, therefore, that in the vicinity of a powerful station it may often be necessary to make provision for reducing the input from the aerial, especially when receiving stations adjacent in wavelength to that of the local transmitter. A variable condenser in series with the aerial will generally prove effective.

WHEN the anode circuit of the detector valve is reached it is often considered that H.F. currents have been finally disposed of, and that this circuit can be treated purely from the "L.F." point of view. In practice this is not so, and it is a fact that the detector grid circuit is sometimes affected profoundly by the arrangement of components in the anode circuit of the valve.

The Detector Anode Circuit

For instance, the tuning of the grid circuit is affected by a change in anode circuit constants. An alteration in capacity of the anode by-pass condenser, which is generally fitted in order to improve rectification efficiency (or rather to reduce anti-reaction feedback), will necessitate re-trimming of the preceding circuit in the case of a gang-tuned receiver. Similarly, the substitution of a different H.F. choke, or the development of a complete or partial short-circuit in an existing choke, will have the same effect.

In addition, any alteration in the anode by-pass capacity will affect reaction control. It is usual to employ the largest capacity possible consistent with retention of high notes and good reaction control.

IT is somewhat disquieting to find that the protective fuses included in a mains-operated receiver "blow" consistently, even though their rated capacity is greater by a considerable margin than the estimated value of current that should be passing through them. In almost every receiver momentary current surges take place when switching on or off, and these surges may be heavy enough to blow fuses which might be expected to have a large margin of safety.

Safety Fuses

Although it may seem to be a rather reprehensible procedure, fuses are often chosen merely by ascertaining by trial which is the lightest value that will stand up to the surges while the set is operating normally.

It follows from this that too much reliance should not be placed on a fuse as a protective device; its presence should not be taken as an excuse for poor insulation or slipshod wiring that may develop a short-circuit at any moment.



Foreign Stations

Reasons for Increasing Popularity

By R. W. HALLOWS

was "proved" first of all that foreign stations could never be worth bothering about since the signal-to-noise ratio must always be such that a mushy, noisy background would be unpleasantly in evidence. When the coming of high-powered transmitters showed that there was a flaw in the argument the next step was to demonstrate mathematically

fading. Violent fading is a comparatively rare phenomenon, and there is no question that automatic volume control can deal satisfactorily with the milder and more usual kind.

The modern set provides genuine high-frequency amplification with complete stability. With modern apparatus at his command the listener can obtain excellent reproduction from stations hundreds of miles away. Nor must it be forgotten that the field strength of many Continental stations is greater in this country nowadays than was that of the local station fifty miles or so away in the early days of broadcasting.

Elaborate Sets Not Essential

Not everyone can possess a large super-heterodyne incorporating all the refinements mentioned or a "straight" receiver with two or more selective and efficient high-frequency stages. Excellent reception of a large number of foreign stations is obtainable with much less ambitious apparatus so long as attention is paid to certain points whose importance is not always realised.

Generally speaking, the user of a small set will find that the best quality is provided by those foreign stations that are most easily and most strongly received. To put it slightly differently, first-rate reproduction is seldom to be expected from stations which have to be "worked up" to good loud speaker strength by critical adjustments of the reaction control.

When a programme is being transmitted simultaneously by two or more stations it often pays to see which is coming through best. The Stockholm programmes, for instance, are sent out by Motala on the long waves, Stockholm in the upper part of the medium waveband, Gothenburg near the middle of this band, and Hörby in its lower portion. Atmospheric, heterodynes, sparks, mush or fading, can often be "dodged" by changing from one of these stations to another.

Lastly, I would like to stress the importance to the long-distance listener who values quality of having a first-rate earth connection. A bad earth leads often to instability, and it may have such an adverse effect upon the sensitiveness of the set that to obtain adequate strength from foreign stations the reaction coupling has to be made much tighter than is desirable. With modern sets the earth connection is possibly even more important than the aerial. You may obtain respectable results with a bad aerial and a good earth, but no matter how good the aerial is the performances may be poor if the earth is defective.

THERE are still some who persist in the belief that no transmissions except those of their local station can be received well enough to be genuinely worth listening to from the entertainment point of view. Old ideas proverbially die hard, and this belief is a survival from the time when neither transmitting plants nor receiving sets were what they are nowadays. Not so very long ago the service area of a broadcasting station had a radius of no more than fifty miles or so, and if one lived at more than that distance from it first-rate reception was difficult, if not impossible, to obtain. To-day this country may be regarded as lying for all intents and purposes within the service areas of a large number of Continental stations. It is no exaggeration to say that with suitable apparatus their programmes can be received every bit as well as, and frequently better than, those which emanate from home stations.

A good many years ago a regular campaign was started against foreign listening. Its opponents included people of considerable eminence in the world of wireless in those days, and the attitude of at least one high official of the B.B.C. was that anyone who sought to derive entertainment by listening to transmissions from abroad was suffering from an attack of a mild form of temporary insanity which would pass away as his wireless education became more complete.

Distance and Quality

The long-distance enthusiast was jeered at; he was termed a knob-twiddler, or a condenser fiend, or an ether hog; it was said of him that he did not care *what* he heard so long as it was a transmission coming from several hundred miles away. His hobby was but a passing craze; within a short time all sensible people would realise that the local station was the only one that could ever be worth listening to.

It is interesting to look back now at the successive attacks launched during the campaign against the long-distance man. It

that long-distance listening must entail sideband cutting and therefore poor quality of reproduction owing to the loss of the higher audio frequencies. If you were content with *that* kind of reception you were a poor thing with no musical ear and no understanding of the real possibilities of wireless.

Band-pass tuning gave a means of obtaining a useful degree of selectivity without cutting sidebands, and then came the discovery that in highly selective circuits the outer sidebands are not "strictly speaking" cut; they are merely amplified to a much smaller degree than those corre-

IN spite of past efforts to discourage listeners from interest in foreign stations, the popularity of foreign listening has steadily increased and causes which have contributed to bring this about are discussed in the following article.

sponding to the lower frequencies. They are still "there," that is to say, though they may be swamped owing to the much greater amplification that takes place of the lower audio frequencies. Tone-control enabled proper balance to be restored in the post-detector-stages; neither sensitiveness nor selectivity were found to be enemies of high quality, as had previously been taken for granted.

Nothing daunted, those who had sworn to have the scalp of the long-distance enthusiast developed a new line of attack. This time, they assured themselves, they were clearly backing a winner, for fading was the horse that carried their money, and, since fading is a natural phenomenon, it seemed that no improvement in the receiving set could possibly combat its dire effects.

Automatic volume control was long in coming to this country, but once it had arrived it was found capable of taking charge of any but the most violent kind of

News of the Week

Current Events in Brief Review

An Old Spanish Custom

IT is estimated that one listener out of six pays the annual radio tax in Spain.

Is Wireless a Luxury?

THE purchaser of a wireless set in Belgium now pays a "luxury tax" of 9 per cent. of its value.

Try Again

NOT one of the designs submitted for the projected Broadcasting House in Brussels has been considered good enough by the jury of experts.

Maison de la Radio

THE latest Broadcasting House is that recently opened at Lille by the French Postmaster-General. The "Maison de la Radio" is the first of its kind in France, having been specially built for broadcasting purposes.

1,200 Kilowatts from Moscow

THE latest rumour is that Soviet Russia is now contemplating the construction of a 1,200-kw broadcasting station to place all on the Continent within its service area.

This is exactly 1,000 times the power of the B.B.C. transmitter at Swansea, which is the lowest-powered in Europe.

Sir Ambrose Fleming

WE take pleasure in seizing the unexpected opportunity to congratulate Sir Ambrose Fleming, inventor of the thermionic valve, on his marriage to Miss Olive May Franks, a well-known singer, a few days ago. Sir Ambrose, who retired from the Chair of Electrical Engineering at University College some years ago, now lives at Sidmouth, in Devon, and still spends much of his time in the study of wireless phenomena and television.

Radio in U.S. Prosperity Campaign

RADIO will be shrieking as loudly as the "Sign of the Blue Eagle" in President Roosevelt's great campaign to provide employment throughout the United States and bring about a return to national prosperity, writes our Washington correspondent. "The Sign of the Blue Eagle" is the badge granted to those who enter the scheme. It is one of the functions of the radio networks to broadcast without intermission the facts concerning the national effort and its progress. Prominent speakers are recounting how firms can win the right to blazon the "Sign of the Blue Eagle" on their premises and notepaper.

The plans include asking sponsors of commercial programmes to devote part of their time to propaganda for this movement.

America believes that radio is one of its biggest aids towards national salvation.

Those Ultra-short Aerials

ACCORDING to a British United Press message from New York, a Portland, Oregon, man has built a wireless set for his bicycle. The aerial is strung between the handle-bars.

Wireless Again

OF the thousands of German Jews who have fled from Germany, many are stated to be setting up in the wireless business, according to a correspondent who has recently interviewed a number of fugitives. A number have left for South Africa and the Dutch East Indies.

Radio Age Gauge

PROFESSOR FANESSES, a French scientist, is stated to have succeeded in fixing the age of the earth as between 500 and 3,000 millions of years by means

Nottingham Radio Show

THE City of Nottingham will hold its radio exhibition at the Greyfriars Hall, from September 6th to the 14th, 1933. Leading manufacturers and many local traders will be represented.

Summer Clubs

WE have always contended that wireless clubs make a mistake in closing down during the summer months. That the outdoor season can be fruitful in results is borne out by the experience of a number of the more active organisations who have courageously refused to "shut up shop" from April to September. Special congratulations are due to Slade Radio (Birmingham), the Golders Green and Hendon Radio Society, the North Middlesex Radio Society, the Sidcup Radio and Television Club, and the

A Shock

A CONTINENTAL broadcasting engineer returning from work the other evening met his eight-year-old son. Noticing that the child's finger was bandaged, the father enquired the cause. "I touched a wasp," said the child, "and the end wasn't insulated."

It Isn't Cricket

CLASSICAL music and cricket are not mutually repellent, according to the consensus of opinion shown in a dispute now raging in Leicester with regard to the appearance of a radio gramophone on the Leicester County cricket ground. What apparently puts the players off their stroke is jazz music and talks.

Pictures on the Spot

THE Paris "Soir" is, we believe, the first newspaper in the world to use a transportable picture transmitter, packed in a valise, for the use of its reporters. The apparatus is the well-known "Belinograph," and we learn that it is to be used for the rapid transmission of photographs to Head Office from any spot to which the reporter may be called.

Jewish Broadcasting Station

A JEWISH broadcasting station operating on power sufficient to include all Germany in its service area may shortly be erected in Prague by the Jewish Wireless Association. Already the rumour is said to be causing uneasiness in official circles in Germany. The construction of the station is being discussed at the Zionist Congress.

Peace at Last

WE learn that Professor Swardemaker has constructed an absolutely non-resonant studio in Utrecht. Between each of the walls a complete vacuum has been achieved. Each wall has a composition of paper, wood, cork, seaweed, human hair, and a special sort of stone, and the internal wall is hung with a "variety of tissues." It is not stated whether the studio is intended for broadcasting or as a refuge from it.

Interned

GERMANY'S erstwhile broadcasting chiefs have been sent to the Internment Camp at Oranienburg. They include Dr. Magnus, formerly Managing Director of the Reichs Rundfunk Gesellschaft, and Dr. Giesecke, Vice-president of the International Broadcasting Union. When he received this news, Dr. Hans Bredow, the former radio commissioner of the German Post Office, telegraphed to the Prussian Prime Minister, expressing the wish to be treated in the same manner as his former colleagues, who, he declared, were quite honourable.

The charge brought by the R.R.C. against the Directors is that of squandering public moneys.



OLYMPIA, 1933. An exclusive glimpse of the great Show taken shortly before "zero hour." Daring originality in stand design is one of the characteristics of the Exhibition, and the lighting effects have never been equalled. The Show remains open until Thursday, August 24th.

of "radio active analysis of 25 meteorites." Our Paris correspondent tactfully suggests that the Professor's methods might be unobtrusively employed to ascertain the exact juvenility of lady listeners who are averse to supplying the information on the new French licence forms.

A Station Comes Back

OWING to the tremendous public outcry which followed the closing of 1ZR, Auckland, one of New Zealand's most popular privately owned broadcasting stations, the Post Office renewed the licence after about a fortnight's silence. According to our Wellington correspondent, the 1ZR Radio Club, which has a membership of 4,000, organised a mass demonstration of protest at the Town Hall. It was disclosed that the licence had been cancelled because of an ambiguous announcement which might have been construed as an advertisement.

Bradford Experimental Radio Society, all of which have been exceptionally active with field days and ordinary meetings. The Bradford Society has met weekly throughout the summer with an average attendance of over fifty.

Societies capable of such vitality in the summer cannot possibly be unsuccessful during the winter, and we hope that their enthusiasm will be amply rewarded when the indoor session begins. There is no better way of keeping in touch with practical wireless matters than by joining the local club and enjoying the freemasonry which exists among all keen radio men.

Secret Transmitter?

MR. WANG FU-SHIIH, a student of Tungchi Engineering University, Shanghai, claims to have invented a portable radio television transmitter capable of sending messages in absolute secrecy, writes our Washington correspondent.

Notes on the New Monodial Super

Getting the Best Out of the New Superheterodyne

By W. T. COCKING

FULL details of the construction and the initial adjustments of the New Monodial Super have already appeared,¹ and little more need be said about the receiver itself. Since the performance may be greatly affected by such external factors as the aerial system and the loud speaker, however, it is felt that some attention should be devoted to matters of this nature.

The aerial and earth system, although often overlooked in these days of sensitive receivers, is still an essential feature. With the receiver in question the earth is perhaps of less importance than the aerial, for the set is essentially stable and hum-free; nevertheless, it is wise to use as good an earth as possible. The best type of aerial, however, is a matter upon which it is impossible to be dogmatic, for it depends greatly upon local conditions. In cases where the set is used in a district remote from any broadcasting station, it is usually best to employ an efficient aerial, even although the sensitivity is sufficient to give distant reception with a poor collector, for the best reception of very weak stations and the full benefit

valve or the first detector being overloaded. Any overloading, of course, would result in the production of whistles. The limitation to the size of the aerial may be either physical or electrical; the latter is often the more convenient, and it can take the form of a small condenser connected in series with the aerial lead to the set. The optimum value should be found by trial, since it will depend upon the

NO receiver will give of its best unless the associated apparatus is suitable. In this article, hints are given on choosing a loudspeaker for the New Monodial Super and on installing it to the best advantage.

actual size of the aerial and upon its nearness to the local station, but a capacity of some 0.0002 mfd. will often be suitable. It should be emphasised that such limitation of the aerial size is only rarely necessary, for the receiver will handle an unusually large signal input

before overloading occurs.

The loud speaker is the next matter deserving attention, for upon it largely depends the quality of reproduction which is secured. In itself, the receiver gives an overall response which is substantially level up to 7,000 cycles, and if the full benefit of this is to be obtained it is obvious that the speaker should give a similar response. Moreover, since the maximum output is about 6 watts, the speaker should be designed to handle this input, otherwise amplitude distortion will occur.

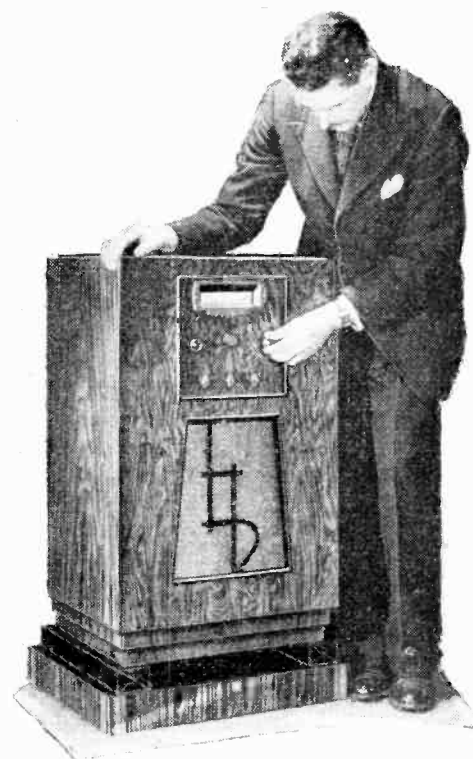

The New Monodial Super housed in a C.A.C. burr-walnut cabinet.

a single similar speaker, and a good dual pair will usually handle 5 to 6 watts comfortably. Furthermore, by the staggering of resonances, the frequency response curve is smoothed out so that the audible effect of resonances is largely eliminated.

Dual speakers are usually obtainable with field resistances of 2,500 ohms per speaker, so that a pair of fields connected in parallel is directly applicable for energisation from the power unit, which has, in fact, been designed with this point in view. Many suitable types are available, and the products of firms such as Celestion, Magnavox, and British Rola are all worthy of examination.

Single Speaker Types

It is sometimes difficult to fit dual speakers into the conventional type of cabinet, however, and it is fortunate, therefore, that their use is by no means an essential factor to the attainment of a high standard of quality. Many of the larger type of single moving-coil speakers are designed to handle an input of 6 watts, and are capable of an entirely satisfactory performance. Speakers of this type usually have a fairly large diameter cone with a very free mounting, so that a large amplitude of vibration is possible, and the field energisation required is often up to 20 watts.

One very well-known speaker which falls into this category is the B.T.H. R.K. Senior, and it is rated to handle 5 watts; its speech coil impedance is 15 ohms, so that the output transformer, about which more later, should have a ratio of 25.8-1, or with sufficient accuracy, 25-1. Unfortunately, the field resistance of the standard model is 5,000 ohms, so that it is not directly applicable to energisation from the power unit. It could be used with a separate source of field current, however,

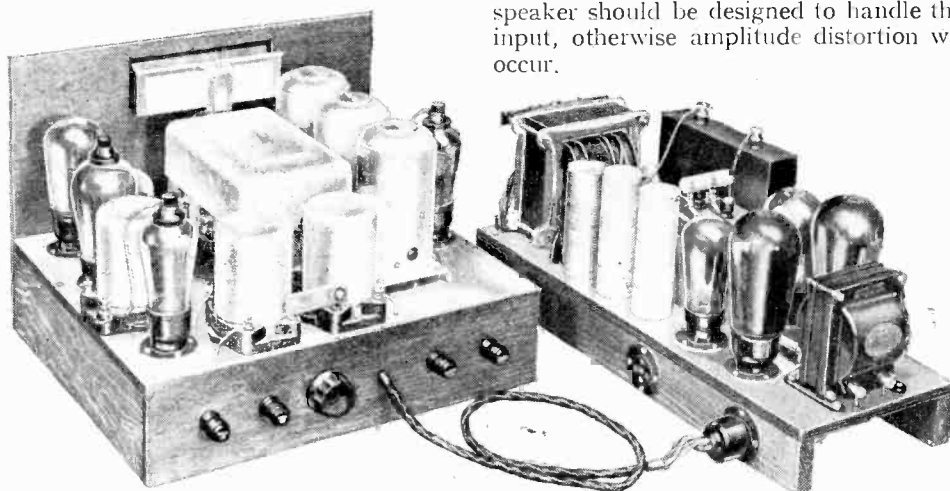

The push-pull output stage, together with the mains and smoothing equipment, are built as a separate unit from the receiver.

of A.V.C. in counteracting fading will then be secured.

If the set be used in the shadow of a local station, however, it is a wise plan to limit the size of the aerial in order to avoid any possibility of either the H.F.

Dual-matched pairs offer themselves as one type capable of giving a satisfactory performance. In this arrangement, two similar, but not identical, speakers are used, and their natural resonances are arranged to occur at slightly differing frequencies. As a result, the power handling capacity is more than double that of

¹ The Wireless World, July 21st and 28th, 1933.

New Monodial Super.—

or the field could be rewound to a resistance of 1,250 ohms.

Another specimen of this class is the Ferranti M.1 model, for this is rated to handle 6.5 watts; it has a speech coil impedance of 20 ohms, so that here the transformer ratio should be 22.5-1. This particular speaker is a permanent magnet type, so that no energisation difficulties arise; when using it, however, it is necessary to fit a 30H., 1,250 ohms, 120 ma. choke to the power unit.

Guarding Against Resonances

In perhaps the majority of cases the speaker will be fitted into a cabinet instead of being mounted on a baffle board, and if boominess is to be avoided it is necessary to guard against box resonance. Although it is possible so to adjust matters that box resonance occurs at a frequency at which the speaker response is deficient, and so actually improves the final result, this requires a high degree of skill. In general, therefore, it is wise to content oneself with choosing a wide and shallow, rather than a narrow and deep, cabinet, and if any trace of box resonance should be found, it may often be removed by providing a lining of acoustically dead material. The use of slag wool packing in the well-known manner is also beneficial.

If the receiver be mounted in the same cabinet as the speaker, a further point to guard against is acoustic reaction. This rarely occurs in connection with the valves in a modern set, but usually to the plates of the variable condenser, and, even if it is not present in sufficient intensity to set up a sustained howl, it may cause a low-frequency resonance similar in its audible effect to box resonance. Fortunately, the cure is simple, and consists merely in mounting the whole receiver chassis on blocks of sponge rubber so that it can float freely.

These questions of box resonance and acoustic reaction are of considerable importance, as is also the low-frequency resonance of the speaker, for they are the

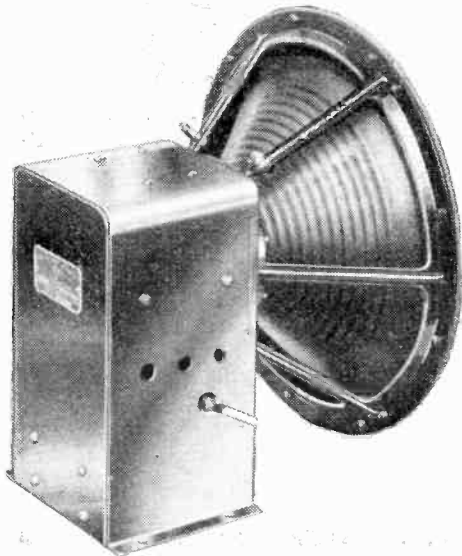

A well-known large cone speaker—the B.T.H. R.K. Senior.

usual cause of boomy reproduction. Although it is not difficult to reduce them to small proportions, in extreme cases a slight modification to the set might become advisable. Where such resonances are found, therefore, it is useful to note that the bass amplification may be reduced slightly by the simple expedient of fitting a 2-mfd. second detector anode circuit decoupling condenser instead of the 1-mfd. condenser specified. In the other case, where the bass is deficient through the use of a speaker with a poor low-frequency response or a small baffle, the bass can be increased by decreasing the capacity of this condenser; 0.5 mfd. to 0.25 mfd. is then recommended. It should be emphasised that the normal value of 1 mfd. is right for normal conditions as to speaker and cabinet, and it is actually intended that the receiver be included in the same cabinet as the speaker, so that it is unlikely that any difficulty would be experienced. The remarks in this article are based chiefly upon abnormal circumstances, in order to point out the path which must then be followed for the attainment of normal results.

In conclusion, a word about output transformers is not out of place. A push-pull transformer with a primary inductance of some 60h., a low D.C. resistance, a power rating of 6 watts, and a ratio depending on the speaker, is necessary. In

some cases suitable types of transformer are supplied with the speaker, but in others a separate component must be obtained. Unfortunately, there are not many types available with the requisite

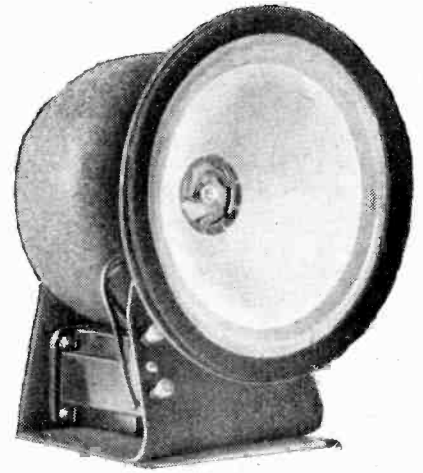

A 6.5 watts permanent-magnet speaker—the Ferranti M1.

primary inductance and power rating which have also a good characteristic at high frequencies. It is hoped, therefore, to publish constructional details of a transformer specially designed for use with this receiver in an early issue of *The Wireless World*.

A NEW AUTOMATIC GRAMOPHONE

Simplicity and Reliability
Combined in an
Ingenuous Design

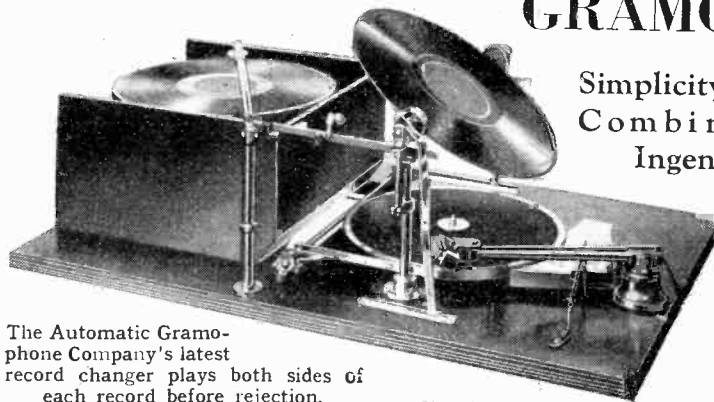

The Automatic Gramophone Company's latest record changer plays both sides of each record before rejection.

THE established gramophone enthusiast with a large stock of the older type of recordings in which each record of a symphony must be turned over in order to maintain the correct sequence has not been so well catered for by manufacturers of record changing devices, and it is gratifying to learn that a new machine is now in production which performs this function automatically and reliably.

The new design has been evolved and is made by The Automatic Gramophone Co., 8, Imperial Arcade, Western Road, Brighton, and is extraordinarily light and compact having regard to the complicated function it is called upon to perform. The records are stacked in a magazine at the left of the motor board and are fed along parallel guides to a position immediately above the turntable to which they are lowered by a flange rod passing through the hollow spindle. After playing one side the same rod lifts the record to a point just

above the level of the guiding rails where it is clamped diametrically between rubber pads, turned through 180 degrees and again lowered to the turntable. After playing the second side

the disc is rejected through a slot into a container underneath the record magazine.

We were particularly impressed with the smooth manner in which the whole operation is carried out; the record is lowered gently into the "used" compartment and not dropped. The time taken in turning over the record was 20 seconds, but we understand that in the production models this will be reduced to about 10 seconds.

A complete radio-gramophone incorporating a seven-valve superheterodyne in conjunction with the record changer is now available at 60 guineas, and the changer mechanism will also be sold separately, the price having been provisionally fixed at 12 guineas. At the moment the instrument is designed to take 10-inch records which statistics show to be the favourite size with the public and which are selling at the present time in large numbers, but designs are now in hand for a model which will handle alternately 10-inch or 12-inch records.

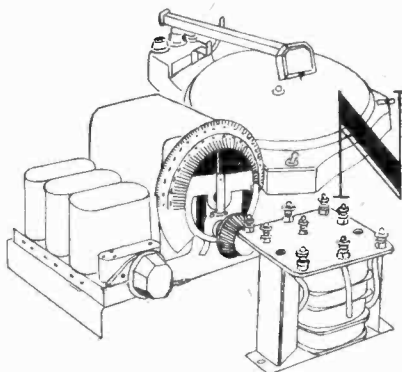

NEW COMPONENTS AND ACCESSORIES

A Wide Choice and Some Interesting Innovations

THE general improvement in the design of components shown at Olympia would in itself constitute a very profitable year's work. Yet when to this is added the latest developments in tuning coils and the establishment of a new output system for battery receivers the total sum of the year's progress might well be regarded with no little satisfaction.

New developments invariably call for special components, and the two cases cited are no exception to the rule. Hitherto coils for use in high frequency circuits have been of the air-cored type, and while this style will doubtlessly continue to be employed for many purposes, the latest models, in which a magnetic core of high permeability material is used, are likely to prove the more popular for the coming season's receivers. For not only are they more compact, but, in general, show a marked improvement in efficiency over the orthodox pattern, and a receiver fitted

a substantially closed core for the medium-wave winding and an open one for the long-wave section. They are, of course,

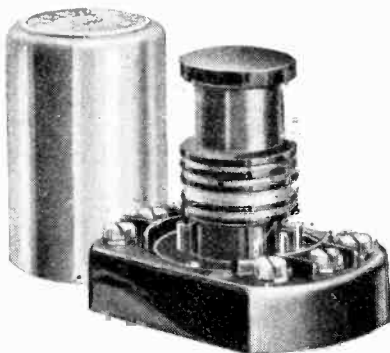

Telsen iron cored coil.

entirely screened and embody a wave-change switch.

Colvern and Igranico both favour a closed magnetic circuit for their Ferrocort and Igranico coils respectively. The Ferrocort range is particularly extensive, there being a coil for every circuit arrangement, or for use wherever the well-known "K" type were employed formerly. In addition, a new miniature style has now appeared which, although requiring less space than the earlier pattern, possesses similar characteristics and the same inductance values. Superheterodyne I.F. transformers fitted with the new Ferrocort cores are now available.

The Igranico coils are wound on a sectionalised bobbin assembled on "E" and "I" laminations consisting of a finely powdered iron mixed with an insulating material and then moulded under heat to the required shape. There are five different coils in this series, including one for the short wavebands.

Examples of coils with open magnetic circuits are the Telsen and the Varley models. Here, again, a wide variety of

Radio Instruments, in their Nicrion coils, make use of a divided core with provision for varying their relative positions, and as this alters the permeability of the magnetic circuit it offers a simple adjustment of inductance, so that coils may be accurately matched under working conditions, or, if a combination of air and iron cored coils is used in the same circuit the inductance of the latter can be easily aligned with that of the former. Lissen and Sovereign Products also have a range of iron cored coils.

Permeability Tuning

Since variation in the position of the core alters the inductance, and, therefore the wavelength, to which the circuit is tuned, it follows that a variable condenser might be dispensed with and tuning effected by this means. Sovereign Products have introduced a "Permeability Tuner" embodying this principle, and single as well as ganged-coil models are available covering the medium as well as the long waveband. Varley have for some time been investigating this line of thought, and on their stand they have an experimental model which is also described as a "Permeability Tuner." Practical

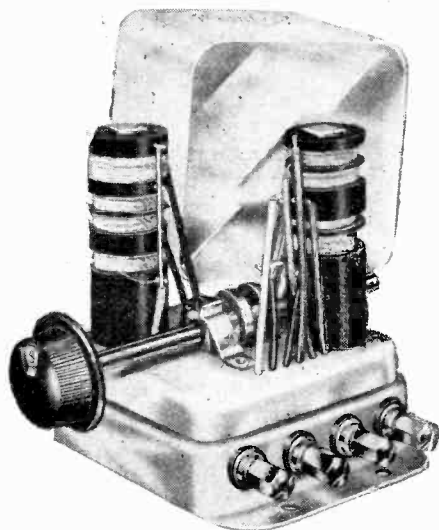

Wearite Nucleon Junior coil.

with the new coils possesses better selectivity and higher sensitivity than one of equivalent style using the familiar small-diameter air-cored coils.

Iron Cored H.F. Coils

Opinions seem to be divided as to which is the most suitable form for the core, since some manufacturers favour a closed magnetic circuit, while others prefer the open type. Wright and Weaire, however, adopt both styles in their range of Nucleon coils, the Junior models have open magnetic circuits, but the Senior coils are fitted with

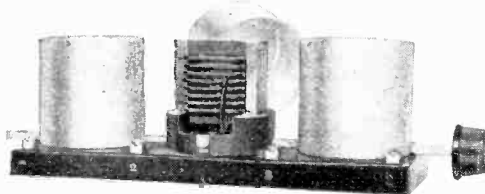

Igranico band-pass coil unit.

coils with different windings are available, either as separate units or assembled on sub-panels containing any combination of coils complete with ganged switch.

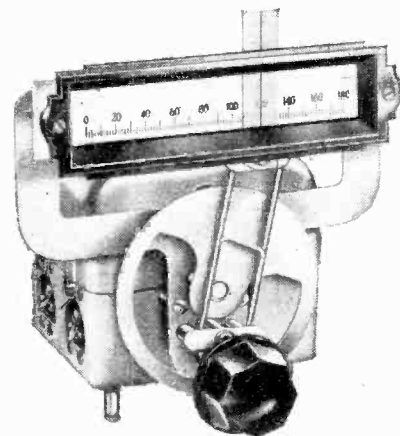

J.B. Nugang condenser and full vision scale.

tuning devices on these lines will undoubtedly be further developed.

The principal changes effected in the design of gang condensers have, in the main, been directed towards a reduction in size. Incidentally, the workmanship is better, matching of the several sections has attained a satisfactorily high standard, and prices are a shade lower, so that on the whole one obtains better value for money this year. A good example of modern practice in condenser design is

New Components and Accessories—

found in the Polar Star Minor series, a new range of gang condensers just introduced. Baseboard space is saved by assembling the condensers with the stator vanes verticle; this has the additional advantage that it brings the small trimmers on top and so readily accessible. Stout

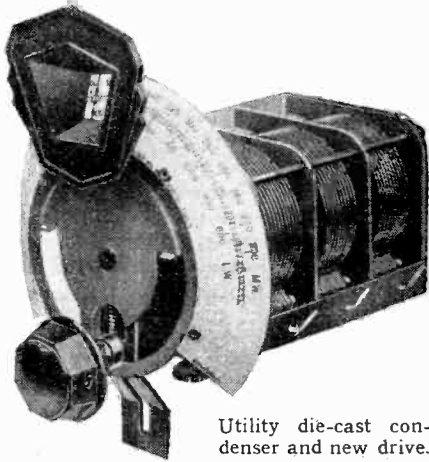

Utility die-cast condenser and new drive.

steel frames, rigid construction and a semi-flexible mounting, coupled with close matching of the sections, constitute the main features of this design. The range includes straight and superheterodyne models.

Jackson Bros.' Nugang and Superhet-gang condensers remain substantially unchanged but for a few minor modifications. The principal matter of interest is the provision of alternative superheterodyne types; these are now available with the oscillator section located either at the front or at the rear of the condenser.

Smaller Gang Condensers

British Radiophone have extended their range and introduced a series of miniature gang condensers for straight and superhet circuits. Constructionally these follow similar lines to the type they fit to their Radiopaks, the stator sections being verticle, so conserving baseboard space and bringing the trimmers to the top. The new Utility die-cast condensers are another example of compactness and sound design. Superhet models are also featured.

That an agreement is being reached in the design of superhet condensers is now apparent, for British Radiophone, J.B. and Polar have designed their respective models for use with coils of the same

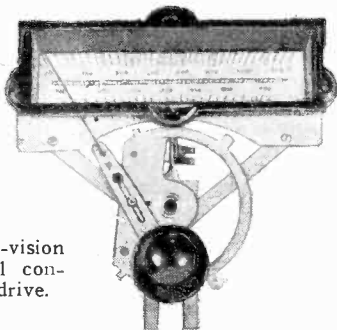

Polar full-vision horizontal condenser drive.

inductance. For the pre-selector circuits coils of 157 mH. and 1,900 mH. for the medium and long wavebands are required,

while for the oscillator the inductance values are given as 126.5 mH. and 920 mH. respectively. I.F. amplifiers of 110 kc/s are specified, and this applies, also, to the Utility models. Further examples of up-to-date gang condensers are the Ferranti and Ormond makes.

Much thought has been given to the design of condenser dials this year, not only with the desire to improving them mechanically, but also from the æsthetic point of view. The fixed scale with moving pointer type is rapidly gaining favour, and all the leading condenser makers now include several models in their respective ranges, and in many cases wavelength calibrated scales are adopted.

The modern practice of tuning simultaneously all H.F. circuits, and in superhets also the oscillator, demands no little skill and considerable patience for the initial adjustment of matching and tracking, and incorrect alignment of any one of the several circuits will lead to disappointing results. In order to relieve the constructor of as much of this tedious work as practical considerations allow, British Radiophone last year introduced their

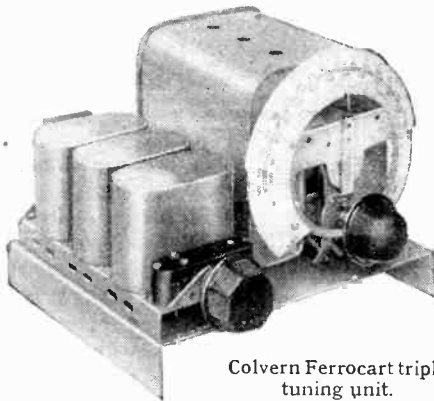

Colvern Ferrocart triple tuning unit.

Radiopak, a unit embodying aerial and H.F. circuits matched and correctly adjusted, this being carried out with the aid of special test apparatus which ensured an order of accuracy not easily attained by the average set builder.

This year sees an extension of the Radiopak principle, and several new models for straight, as well as for superheterodyne receivers, have been introduced. A unit on somewhat similar lines has been developed by Igranic. Known as the Igranipak, it takes the form of a complete two-H.F. and Det. unit, and embodies, also, the valve holders and all the essential components for the input portion of the set.

Short-wave Developments

The Sound Sales Straight to Superhet Converter might be included under the same heading, for it consists of a frequency changing unit utilising an H.F. Pentode in the dual rôle of oscillator and detector, and is intended for the conversion of a straight set to a superheterodyne for use on the normal broadcast wavebands. Colvern, likewise, have several coil and condenser units assembled on small metal sub-panels for embodying in receivers.

The requirements of the short-wave listener are well catered for this year, and

in particular by Stratton and Co., the short-wave specialists and makers of Eddy-

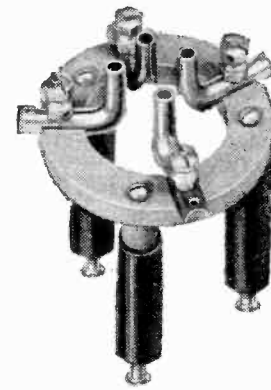

Eddystone ultra-short-wave valve holder.

stone components. A new condenser, styled the Scientific S.W. model, has been developed, due attention being given to low-loss construction and noiseless operation. This style is made in sizes of from 35 m-mfds. to 150 m-mfds., so covering the ultra-short as well as the normal short-wave bands. A special ultra-short wave valve holder raised on pillars is another new Eddystone product, these developments being indicative of the interest now being shown in 5-metre work.

British Radiophone and Polar have each introduced short wave condensers, and Jackson Bros. a new slow motion dial having a finely engraved scale with 200 divisions, a hair line indicator and twin ratios of 8:1 and 150:1. Another example is the Igranic Indigraph Vernier knob and dial which in its modified form gives reduction drives of 8:1 and 500:1, the vernier drive now being brought in or put out of action by a simple cam mechanism. Ormond, also, have a short-wave condenser embodying a 50:1 reduction drive.

The popularity of the Class "B" output stage was a foregone conclusion as soon as details of the arrangement became public. That it has now definitely established itself is exemplified by the exceptionally large number of special components shown this year. Since it is a

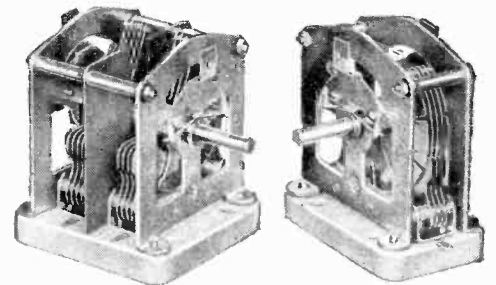

British Radiophone short-wave condensers.

push-pull arrangement an input transformer having a centre-tapped secondary is required, but, unlike the usual intervalve coupling unit of this type, the particular nature of the system calls for a step-down ratio between primary and secondary, but with the secondary winding of low D.C. resistance. Multitone Electric were the pioneers of this class of component, and their present range is very extensive indeed. In order that the one component may serve for several different combinations of valves the majority of driver transformers offer the choice of two or more ratios. Typical examples of dual-

New Components and Accessories—

range models, giving a 2:1 and a 3:1 step-down each half, are the Benjamin, Bulgin, Igranic, Sound Sales, Telsen and Varley makes. Still others, such as the Amplion, Sovereign and Wearite, for example, provide several alternative ratios, while we find in some cases that a range of single ratio models are made. British Radiophone, Multitone and Ferranti being the principal firms interested in this type.

Class "B" Converter Units

Since correct matching between the output valve and the loud speaker is a very necessary condition if the full benefit

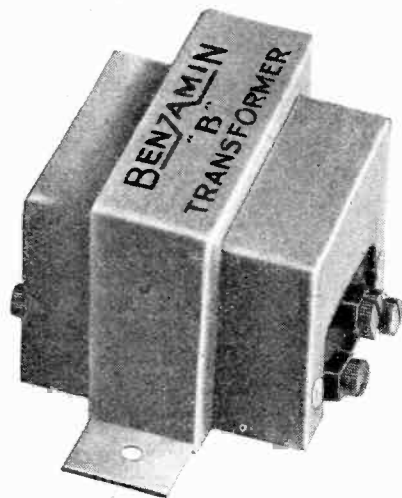

Benjamin Class "B" driver transformer.

conferred by this arrangement is to be obtained, either a special output transformer or a tapped choke of high inductance must be used. Consequently, every manufacturer of driver transformers includes in his range either the one or the other. The special chokes are provided with several tappings thereby giving a wide choice of ratios and enabling practically every make of Class "B" valve to be satisfactorily matched to a standard model loud speaker.

This new system of power amplification will appeal to all users of battery sets, for an existing receiver can so easily be converted. The original output stage becomes the driver valve and all the additional components can be assembled in a separate unit used external to the set, and this fact has not escaped the notice of the



Varley Class "B" output choke.

manufacturers, for several quite inexpensive units are now available. Prices range from about 30s. to 70s., according to the power handling capabilities of the unit

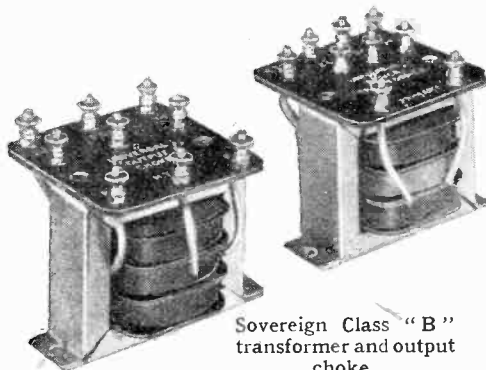

Sovereign Class "B" transformer and output choke.

and typical examples are the Baker's, Ferranti, Multitone, Sonochord, Sound Sales and W.B. models.

The progress made in the design of the dry-cell type H.T. battery is unfortunately not easily detected since it takes the form mainly of improvements in manufacture directed towards lengthening the useful life of the battery by reducing the internal resistance of the cells. What is apparent, however, are the many new models introduced for use with Class "B" receivers. While, in the main, these could be classified as double, or extra, capacity sizes, for they are required to withstand an average discharge of the order of 12 mA, the instantaneous demand often exceeds this figure by an appreciable amount. It says much for the manufacturing processes of our battery makers that during the development stages of Q.P.P. and Class "B" the normal dry battery of the time

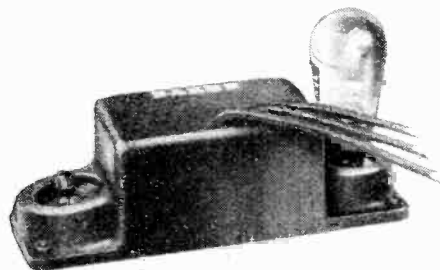

Baker's Class "B" converter.

successfully withstood the demands made on it so that with the latest types, as exemplified by the Anodex, C.A.V., Drydex, Ever-Ready, G.E.C., Grosvenor, Hellesen, Oldham, Pertrix, Siemens, Sparta and Vulco batteries, entire satisfaction can be assured. As an alternative to the dry-cell type of battery there is the H.T. accumulator which, like its contemporary, has been the subject of improvement, but, here again, only detailed modifications have been found necessary to bring them right up to date. They will find favour mainly where heavy discharges are required. Examples of the high standard now attained in the manufacture of this type of H.T. supply are the C.A.V., Dagenite, Exide, Oldham, and Smith's products.

These firms are responsible, also, for providing L.T. accumulators for the filament supply. Considerable advance has been made in the design of the "Mass"

type plate, a style of construction which permits of a long and slow discharge at a very low rate without sulphation trouble being encountered.

Quite a new development, however, is the Block battery, now available in H.T. as well as in L.T. types. The usual lead grid is omitted and only the active material employed, thereby resulting in a marked reduction in size and weight for a battery of given voltage and capacity. The Milnes H.T. accumulator, although not a new development, is now considerably improved. It makes use of nickel-cadmium plates and a non-corrosive alkaline solution, which combination is capable of withstanding rough usage

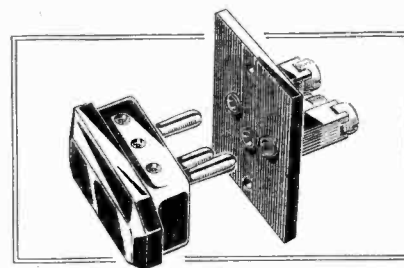

Belling-Lee Class "B" three-point connector.

without suffering damage. A special series-parallel switch is fitted so that the battery may be re-charged from an L.T. accumulator.

Mains Components

This year there is a marked increase in the number of "stripped" mains transformers and chokes available to the home constructor. This type, sometimes referred to as the manufacturers' type, is supplied without terminals, the ends of the windings being left sufficiently long to join to other components in the set, or in the power pack. This makes for a much cleaner appearance of the set, for the transformer is usually mounted so that all the leads pass directly through to the underside of the baseboard. A special feature is made of this type by Bulgin, while a further example is the Sound Sales ranges.

Electrostatic screening of the primary and totally enclosed windings are two other features that have been further



Siemens 120-volt H.T. battery for Class "B" use.

developed this year; examples of up-to-date practice are the B.S.R., Davenset, Ferranti, Godwinex, Igranic, R.I., Wearite, and Varley models, in addition to several other makes.

New Components and Accessories—

On the whole, battery eliminators take much the same form as hitherto; compact models no larger than an average H.T. battery and easily stowed away in a portable set still predominate. J. Dyson have redesigned their range of Godwinex units, and H. Clarke & Co. (M/cr.), Ltd., have introduced several new Atlas models, of which some are designed especially for use with Q.P.P. and Class "B" receivers.

A new range of A.C. and D.C. models has been introduced by Telsen, and Ferranti have some improved types also. As in the past, many of these models incorporate small trickle chargers for the L.T. battery. Bulphone Radio, Ekco,

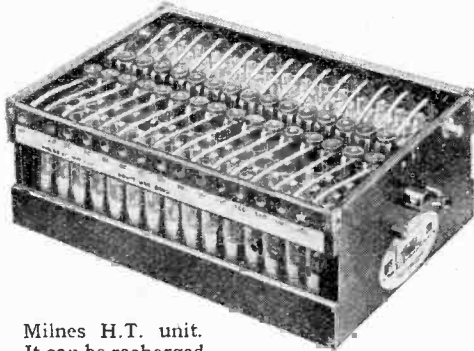

Milnes H.T. unit. It can be recharged from the L.T. battery.

Mains Power Radio and Regentone are further examples of H.T. units embodying the most up-to-date features.

Battery Charging

There are many listeners whose sole interest in radio is its entertainment value, and the technicalities of the science have always been and will for ever remain a mystery. However, there is nothing unusual in this, for to enjoy to the full many of the pleasures of life it is quite unnecessary to know why and how those things that give us pleasure are brought about. Consequently the upkeep and maintenance of the wireless apparatus is left to those who have made this their particular business in life. Battery charging comes within this category, for in recent years battery service stations have opened up



Exide series "D" mass-type cell with gravity floats.

in every locality large and small. Equipment for this purpose has, however, developed rapidly, and to-day there is a very large selection of charging sets designed especially for the service engineer. The Newton range is a particularly fine example of modern practice, for it includes models of from six to fifty amperes output and arranged so

that several different sizes of batteries can be handled by the one set.

Partridge and Wilson have further developed their Davenset series, and now have models to meet all requirements,

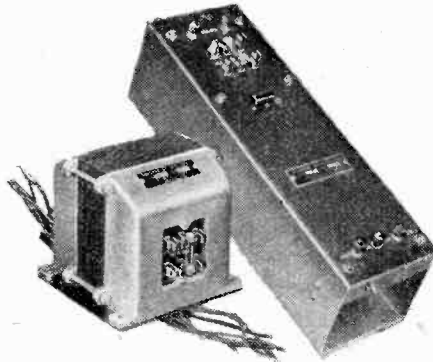

Sound Sales mains transformer and Westkit eliminator kit.

while Crypto have introduced a new range with valve rectifiers, and one styled the "Karadio" charger for home use, which is suitable for both wireless and car starter battery charging. It utilises a valve rectifier and adjusts itself automatically for 2-, 4-, 6-, and 12-volt batteries. Mains Power Radio have developed a range of battery service station charging sets also.

Home charging of L.T. accumulators is being catered for more extensively than hitherto, for Heayberd have introduced a range of units using Philips valve rectifiers which handle car and radio batteries, while a further example is the Sound Sales model.

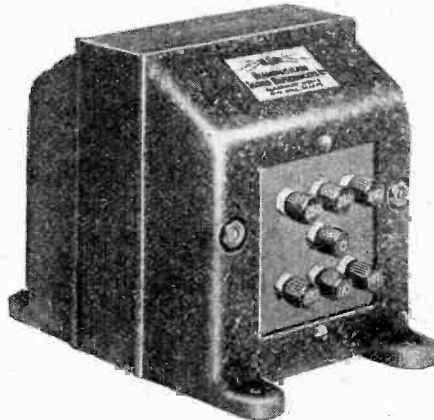

B.S.R. fully screened mains transformer.

Westinghouse metal rectifiers have received their annual overhaul, with the result that the H.T.6 and H.T.7 styles are now dropped and replaced by one model, the H.T.12. This gives an output of 30 mA. at 200 volts, and is more in keeping with present-day requirements. There is, also, an H.T.13 model having particularly good regulation, which has been introduced for use where Q.P.P. or Class "B" amplification is employed.

The improvement effected in modern receivers is not without its price, for with increased sensitivity trouble is now being experienced from electrical interference to a far greater extent than ever before. Whilst home domestic appliances offer little difficulty in their treatment, since condensers suitably disposed will effectively silence them, the interference produced

from similar apparatus elsewhere cannot always be dealt with quite so easily.

Interference of this nature is either brought in by the mains or picked up by the aerial. In the case of the former a mains filter will generally suffice to eliminate the trouble, and several very useful units are now available, the principal firms making them being Belling and Lee, British Blue Spot, Bulgin, and T.C.C.

Interference Suppressors

So far as the second mentioned cause of the trouble is concerned, it is now generally accepted that only the vertical portion of the aerial comes within the field of interference, and that by the use of a screened down-lead almost entire immunity can be ensured. Typical examples of interference

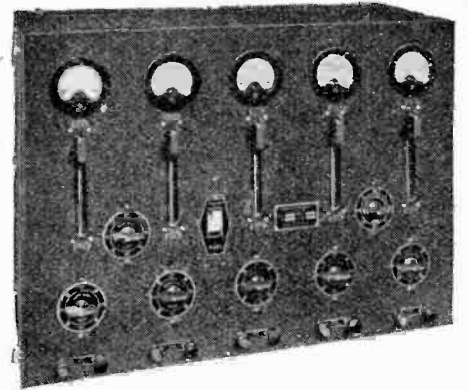

Davenset type M.G.C.5 five-circuit battery charger.

suppressors of this type are the British Radiophone Receptru Anti-Static Down-lead, the Lamplugh Silver Ghost Antistat aerial unit, and the Bifco Static cut-out, made by the Osdue Manufacturing Co.

The small tubular pattern fixed condenser with wire ends for suspending in the wiring has been further developed this year, for with sets being condensed into still smaller compass there is naturally a demand for any component not requiring baseboard space. In this style there are now a number of low-voltage dry electrolytic condensers in capacities up to 50 mfd. or so, and suitable for grid circuit decoupling. Dubilier, Telsen, and T.C.C. have extended their respective ranges to include this pattern.

The cylindrical type electrolytic smoothing condenser maintains its well-merited popularity, and while not materially dif-



Lamplugh Antistat aerial unit.

New Components and Accessories—

ferent in general form has, in most cases, been subject to sundry minor improvements. Telsen now have a range in this pattern.

Paper dielectric smoothing condensers

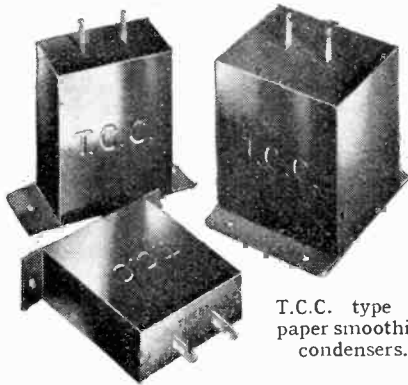

T.C.C. type 87 paper smoothing condensers.

have been improved by all the makers of this style; working voltages are higher, without material increase in price, and a larger margin of safety is allowed. A typical example is the T.C.C. type 87, which, rated at 450 volts D.C. working, will withstand surges up to 650 volts, and they are tested at 1,500 volts D.C.

Set Testing Apparatus

Quite a casual examination of the modern receiver as shown at Olympia suffices to show that it is far from being a simple, straightforward piece of apparatus, and should it fail to function in a satisfactory manner the non-technical user will

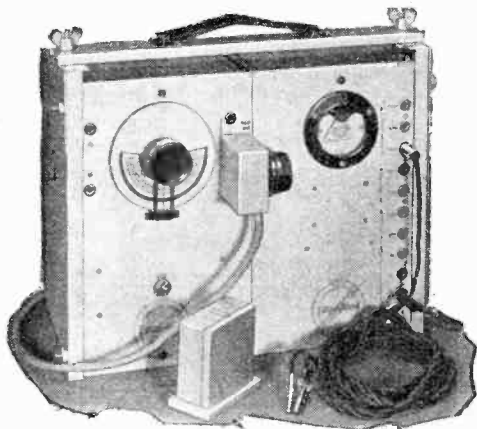

Standard Telephones radio service test set in portable form.

soon find himself in a quandary if he endeavours to assume the mantle of the service engineer. Servicing has now become a highly technical profession, and can be undertaken only by those adequately equipped for the purpose. As a consequence the requirements of the service engineer are being catered for more fully this year than ever in the past. Special apparatus is a necessity, and no longer a luxury, for the accurate and rapid diagnosis of faults and failures occasionally encountered in present-day sets. That they are few and far between is to the credit of our manufacturers, but when trouble is encountered it is usually a matter for the expert to rectify. So Standard Telephones and Cables, Ltd., have intro-

duced a range of radio service test sets, made up in separate units, which can be acquired from time to time, and so eventually building up a complete equipment for overhauling and servicing the most complicated receiver yet developed for broadcast use.

These comprise a modulated oscillator, output meter, and attenuators, each unit separate and self-contained. The first would suffice for everyday tests and adjustments; with the output meter added, visual indications and measurements replace aural tests, and with the help of a calibrated attenuator overall curves of the receiver can be taken. And these units are quite reasonable in price.

The Radiolab complete valve and test set is another example of portable equipment for the service man, while for the expert as well as for the amateur experimenter is the range of Avonmeters, to

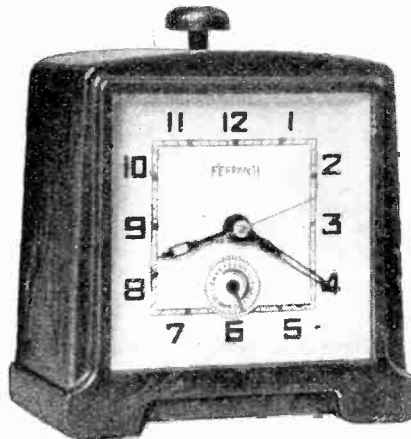

Ferranti electric alarm clock.

which has now been added the Avominor, an inexpensive version of the larger instruments. Then, of course, there is the exceptionally wide range of Ferranti meters. Incidentally, the last named firm have considerably extended their range of electric clocks, and one of the latest models now embodies an alarm mechanism.

Gramophone Pick-ups.

It is a tribute to the general excellence of modern pick-up design that very few changes have been found necessary in the



New R.I. Auto-Parafeed transformer for parallel feed auto-coupling.

established makes exhibited at last year's show. When the electrical reproduction of gramophone records first became popu-

lar a number of pick-ups made their appearance which contained the essential magnet, armature and pick-up coil, but of which very little was known regarding the output characteristic. When constant frequency test records became generally available all these crude attempts at design died a natural death,



The Bowyer-Lowe "Mark IV" pick-up is supplied in two types with different frequency characteristics.

and it is safe to say that in all the makes now on the market the frequency characteristic conforms to the fundamental principles of design which are accepted as giving the best possible quality of reproduction from records.

That the output characteristic is completely under control is exemplified in the latest Bowyer-Lowe Mark IV pick-up. This has a frequency range from 25 to 6,000 cycles and an average output of the order of 1 volt R.M.S. In the standard model there is a pronounced rise of output in the bass to compensate for deficiencies in the average amplifier and loud speaker as well as in recording, but an alternative model can be supplied at the same price in which the bass response is adjusted to give exact compensation for the necessary restriction in amplitude in recording.

The new Celestion P2 pick-up is another good example of design in relation to commercial requirements. The price is moderate and by careful damping and reduction in the mass of the moving parts

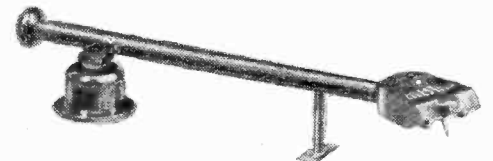

Celestion P2 pick-up and volume control.

record wear has been enormously reduced without in any way affecting the excellence of the frequency characteristic. The self-contained volume control is typical of the modern tendency towards neatness of exterior appearance.

Most readers will be familiar with the principle of hum-bucking in moving coil loud speakers in which a low resistance coil coupled to the field winding and connected in series with the moving coil is used to neutralise any ripple superimposed on the magnetic flux. A similar

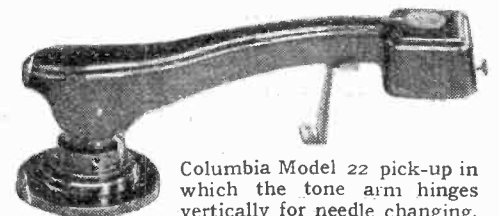

Columbia Model 22 pick-up in which the tone arm hinges vertically for needle changing.

New Components and Accessories—

principle has been applied in the new Columbia No. 22 pick-up, the object in this case being to overcome interference from the synchronous type of gramophone motor. The hum-bucking coil, which is of similar dimensions to the pick-up coil,

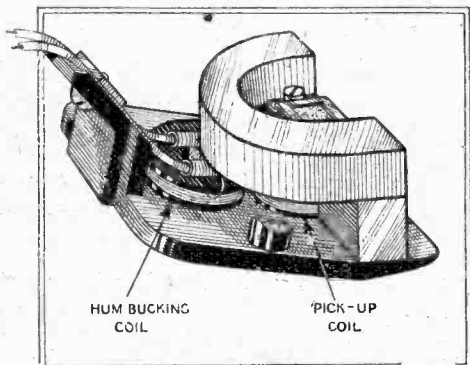

A hum-bucking coil is fitted in the Columbia pick-up to neutralise motor interference.

is mounted close to the latter on the base of the pick-up head, but is not influenced by the fluctuations due to the movement of the needle. Both coils, however, are cut by any stray field arising from the motor and as the coils are connected in opposition any interference from this source is cancelled out.

Many owners of receiving sets who subsequently wish to extend their use to gramophone reproduction are already in possession of portable gramophones of the acoustic type. In order to make use of the existing turntable and motor, Belling-Lee, Ltd. have introduced a special pick-up designed to clip on to the side of the gramophone case. The unit includes a volume control and can be readily detached if it is desired to use the portable in the normal way. The same underlying idea is to be found in the Itonia "Pick-up" portable gramophone, which is provided with interchangeable sound heads for acoustic or electrical reproduction, and is sold complete at the very reasonable price of £3 10s.

Motors and Playing Units

As in the case of pick-ups, the design of the electric gramophone motor would appear to have reached a state of equilibrium in relation to present-day demands.



The new B.T.H. "Truspeed-D.C." gramophone motor.

The high-speed self-starting synchronous motor and the slow-speed induction motor with governor share the honours of supply-

A POCKET OLYMPIA

Next week's issue of *The Wireless World* (dated August 25th) will include a complete illustrated report, prepared by our Technical Staff, of new apparatus shown by each exhibitor at the Olympia Radio Show.

ORDER YOUR COPY NOW.

ing the requirements of those with A.C. mains, while high-speed and slow-speed types are equally popular in the D.C. and universal class.

A revival of interest in battery radio gramophones has created a new demand for clockwork gramophone motors. A complete motor board equipped with a double spring motor, pick-up and volume control has been introduced since the last Show by the Garrard Engineering and Manufacturing Co., Ltd., and makes an

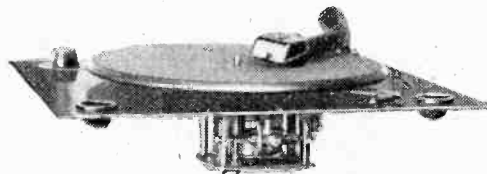

Garrard radio-gramophone conversion unit with double spring clockwork motor.

excellent conversion unit for incorporation with a battery receiver chassis employing the modern types of economical output stage.

A Badge of Service

Wireless League Opens New Campaign

A CAMPAIGN to give the *coup de grâce* to the inexperienced "dabbler" in the radio trade has been initiated by the Wireless League through the reorganisation of the scheme for the registration of approved wireless traders and repairers inaugurated a few years ago by a joint committee of the Radio Society of Great Britain and the Wireless League. The work will in future be continued and extended under the sole auspices of a sub-committee of the League.

Selected service engineers, whose premises, apparatus and personal technical abilities have been approved by a committee of prominent people in the radio world, will be accorded the support of the Wireless League. For example, when a trade service engineer has satisfied the League's certified radio engineer that he can render practical and efficient service, all members



of the Wireless League in his area will be notified and will be recommended to place full confidence in him for all radio service work. He will be entitled to display the League's "service" sign, which, in due course, should become recognised as a badge of status similar to those of the big motor-
ing organisations.

It is believed that listeners in general will be glad to take advantage of the scheme, as at present there are few visible guarantees that the average wireless trader is able to tackle the problems which must of necessity arise in providing the public with such a delicate and complicated piece of apparatus as a wireless set.

FOREIGN BROADCAST GUIDE

BEROMUNSTER

(Switzerland).

Geographical position: 47° 12' N.; 8° 10' E.
Approximate air line from London: 480 miles.
Wavelength: 459.4 m. Frequency: 654 kc/s.
Power: 60 kW.
Standard time: Central European (coincides with B.S.T.).

Standard Daily Transmissions.

10.0 B.S.T., sacred service and concerts (Sun.); 12.28, time signal, weather, news; then continuous broadcast until 19.00, time signal, weather, talks; 19.45, main evening programme; 21.30, news, etc., dance music or concert. Usually closes down at about 22.15.

Language: German only.
Announcers: Man and woman.
Call: *Hallo! Hier Schweizerischer Landessender studio Berne (or) Basle (or) Zurich*, according to the city providing the programme.
Interval signals: The Berne, Basle and Zurich studios each possess a distinctive musical call as under:



BERNE



BASLE



Closes down with good-night greetings in German; Berne usually giving them in dialect: *Gute nacht mitander schlafts alle recht woehl*. The Zurich and Berne studios follow up with their local "signature tunes," the former, *La Re traite*, the latter, *The Berner Marsch*.

Associated transmitters: Basle, 244.1 m. (1,229 kc/s) 0.5 kW.; Berne, 245.9 m. (1,220 kc/s) 0.5 kW.

Radio Amateur Call Book

THE Summer edition of the semi-official list of all known amateur transmitters of the world is now available. The main list, which gives their call signs, names and addresses, occupies nearly 204 closely printed pages and is, we believe, the only complete list of its kind published.

The supplementary information includes a list of the principal short-wave commercial stations of the world, short-wave Broadcasting stations, and those transmitting Press and Weather reports, the International "Q" code, the "R" (Audibility), and the "T" (Tone) codes. Published in Chicago, U.S.A.

Copies may be obtained in Great Britain from Mr. F. T. Carter, Flat A, Gleneagle Mansions, Streatham. Price 6s. 6d., post free, for single copies, or 21s. for the four quarterly issues.

OLYMPIA is open daily from 11 a.m. to 10 p.m. till Thursday, 24 AUGUST

BROADCAST BREVITIES

By Our Special Correspondent

Fight in Television Studio

AUGUST 22nd is *not*, I understand, to be referred to as the birthday of B.B.C. television though it marks the first anniversary of regular transmissions. The term "birthday" is considered to suggest a permanency at Broadcasting House which television does not officially possess. But there is no harm in describing August 22nd as a television Boxing Day, as it were, for, as first exclusively forecast in these columns, that day will be the first occasion of a boxing match before the television transmitter.

Two Challengers

Studio Bb will be decked out as a boxing ring in which Archie Sexton (who is challenging Jock McAvoy for the Middleweight title) and Laurie Raiteri (who is challenging Len Harvey for the Light Heavyweight title) will make history with their fists for ten or fifteen minutes.

The Looker-in

By the way, there are still so few "lookers-in"—their number cannot at the present time exceed 500—that the television artistes sometimes ask before their turn whether they are likely to have an audience or whether, it being a fine evening, he will be out.

A Missed Opportunity at Olympia

The fact that there are no television demonstrations at Olympia is astonishing, for never have the prospects for the art been more rosy than now. At last people are talking television and wondering whether it really is something which can be installed in the ordinary home.

In Days to Come

When television does come, it may mean a respite for the unfortunate people who are doomed to spend their lives as neighbours of loud speaker fiends. When people can look at a programme, they may lose the urge to hear the music at full blast. Until that time I fear there is little hope for the aurally sensitive.

Still the Silly Season

THE silly season has now reached its apogee, and I suppose that from now onwards the news stories will gradually grow more and more sensible.

They are chuckling at Broadcasting House over the journalistic confusion between the outside broadcasts van, which jogs around the Northern seaside resorts (why never the Southern?), and the mobile transmitter which, in spite of its seventy-foot telescopic mast, manages to creep around the country fairly unobtrusively in its search for ideal transmitter sites.

But An Idea Emerges

Stories are now about that the "O.B." van carries a seventy-foot mast, and that the B.B.C. is hoping to get together a fleet of mobile transmitters.

Incidentally, this latter is not such a bad idea. What do you think?

Have You Memorised the Sections?

NOT one listener in a hundred can describe the size and characteristics of Sections A, B, C, D or E of the B.B.C.



(Photo: Duvivier, Paris)

DRAMA ON THE ETHER. Although the French broadcasting stations do not adopt the B.B.C.'s multi-studio methods in radio drama, plays are often rendered very effectively. Here is a new photograph of "La Troupe Théâtrale" broadcasting a comedy from Eiffel Tower.

orchestra. One old lady of my acquaintance believes that Section C is so named because it avoids flats and sharps.

Combination X

Is it still too much for the B.B.C. to be good enough to give these sections more suitable designations? If so, then why not be consistent by calling Henry Hall and his Boys Combination X?

The Bach Cantatas

THAT the Bach Cantatas are to be resumed beginning on Sunday, September 17th, is no cause for moaning, especially as the B.B.C. has wisely decided they will be heard on alternate Sundays.

The Cantatas will be given during the 4.50 to 5.30 p.m. period when the disgruntled can tune in an alternative.

The original complaints were perhaps justified because the B.B.C. over-estimated the public demand by broadcasting a Cantata every Sunday.

Ten years ago it might have been prudent to make the Cantata a monthly affair, but public taste has undoubtedly risen in the past few years, and I do not believe that the new arrangement will constitute an overdose.

Politics on the Ether

THE absence of talks during the summer programme period has emphasised their value and the greatly improved standard which they have reached in recent months.

After the glut of so-called "light" music (much of it has been heavy, without being high-brow) listeners will turn with relief to the vigorous talks and debates which are promised us during the coming winter.

Uncensored Politics

One of the most attractive series should be the weekly uncensored political talks, the first of which will be given on October

12th. The speakers will be Mr. Ramsay MacDonald, Mr. Stanley Baldwin, Mr. J. H. Thomas, Major Oliver Stanley, Sir Herbert Samuel, Mr. Walter Runciman, Mr. George Lansbury, Mr. Arthur Greenwood, and Sir Stafford Cripps.

The talks will last for fifteen minutes each, and the speakers will be entirely unfettered. What is equally important is that listeners will be unfettered in the use of the switch.

The Ulster Grand Prix

TO-MORROW the International Ulster Grand Prix, the fastest road race in the world, will be described in a broadcast running commentary by Major Vernon Brook and H. W. McMullan. The course is more than twenty miles and consists of ten laps, a total of 205 miles. Major Brook will be stationed at the starting point and Mr. McMullan at Muckamore Corner. National programme listeners will hear the commentary in two sections, the first at 1.45 to 2.45 p.m., and the second, describing the last phase, from 4.30 to 5.15 p.m.

Padded Corners

The Grand Prix course is at Carnaughtie, Co. Antrim, and the race is organised by the Ulster Motor Cycle Club. From the start at the Grand Stand and petrol-filling pits there is a slight downward slope to Nutts cross-roads; then an unpleasant hump-backed bridge at Dundesert; after that straight on to Thorn Cottage, a bad corner turning at less than right-angles. Then a sharp climb to Killead Vicarage.

The next points are Aldergrove Aerodrome, downhill to Greenmount Corner, up to Rectory Corner, with a massive stone wall padded with bedding, in case . . .! So to Muckamore Corner, acute right-hand turn and into the seven-mile-and-a-half straight down to Clady Corner, the worst of the lot, where the massed spectators leave a bare six-foot passage for the riders.

Problems of Electrical Interference

The Cure is Beyond the Scope of the Radio Engineer Alone

By A. Morris, B.Sc., M.I.E.E.

DURING the year 1928 John R. Carson, in concluding an analysis of yet another of the many methods proposed for the reduction of atmospheric disturbances, wrote: "The conclusions of this study are entirely negative; that is, no appreciable gain is to be expected from balancing arrangements. This is quite in agreement with the conclusion drawn over ten years ago by John Mills. . . . In fact, as more and more schemes are analysed and tested, and as the essential nature of the problem is more clearly perceived, we are unavoidably forced to the conclusion that static, like the poor, will always be with us."

This statement referred to atmospheric disturbances, and it is fortunate that the position in regard to the interference to radio reception arising from the operation of electrical machinery is not quite so hopeless. Radio engineers concerned with broadcasting have devoted much attention to this aspect of the performance of their equipment and their efforts. Aided by the experience of the communications engineer in his struggle with atmospherics and unwanted transmissions, and assisted by the co-operation of the radio industry generally, some improvement of the position has resulted.

Control of Interference at the Source

When, however, after all possible modifications of the receiving equipment have been made the relative strengths of signal and interference pick-up cannot be made sufficiently favourable, the unaided efforts of the radio engineer come to an end and he is powerless to improve matters alone. Fortunately, unlike the case of atmospheric disturbances, control over the source of the interference can almost always be exercised. This control, however, is in the hands of other sections of the electrical industry, and with the greater development of all forms of radio communication the need for the exercise of this control becomes greater.

The efforts of the radio engineer have been mainly directed to the development of interference-free low-loss radio frequency transmission systems, and to the limiting of the receiver pick-up exclusively to an aerial located in a situation essentially remote from interfering fields.

The transmission system may take the form of an electrostatically screened single wire line or "lead in," or of a balanced double wire transmission line, preferably electrically stabilised by enclosure in a metal sheath. Reflection losses at the two

ends of either of these systems may be minimised by the use of impedance-matched transformers, whilst propagation losses may be limited by the provision of suitable conductors and dielectric. Commercial forms of each of these transmission system items are now available.

For ranges within a fraction of a wavelength from an item of electrical plant the strength of the so-called "direct" radiation from it diminishes rapidly with distance. Thus, at 5ft., 10ft., 20ft., and 40ft. from such a source the strength is approximately 0.01, 0.001, 0.00018, and 0.000018 respectively of the strength at a distance of one foot. By placing an aerial

IN this article, contributed by a radio engineer of the Post Office, it is pointed out that although a good deal may be done to assist in suppressing electrical interference at the receiver, there is a definite limit beyond which the radio engineer is unable to progress, and the real solution of the problem rests with electrical engineers whose equipment produces the interference. This statement entirely endorses the point of view held by "The Wireless World," which has consistently urged the need for legislation to control interference caused by electrical apparatus and machinery.

at a distance from such a source and connecting it to a receiver via an interference free transmission line, it is clear that the strength of the directly propagated interference pick-up from the local source in question may be effectively limited; the greater the separation between aerial and interferer the greater the freedom from interference. In this connection it should be borne in mind that whilst separating distances of about thirty yards to fifty yards between the aerial and the interferer—which are necessary for some intensely interfering items of plant—are possible in some cases, such separations cannot be easily arranged in the case of the ordinary home set. This circumstance limits the possibilities of the method.

The mains-propagated interference from electrical plant is frequently carried considerable distances before being released as interfering radiation. This makes it necessary to provide for even greater separations than would otherwise be necessary. Furthermore, the removal of the aerial to a position remote from the locality of the receiver and of the local interferer

will not necessarily remove it from an interfering source situated at other premises; indeed, the contrary effect may result.

In the case of distant interfering sources the signal-to-noise ratio of the aerial system cannot be improved by the normally practicable application of the anti-interference devices which have been mentioned. Aeroplane and motor car interference with ultra-short waves is a case in point.

In regard to the radio-frequency transmission systems which have been referred to, whilst they render the receiver essentially free from the effect of the interfering fields through which they pass, they necessarily also limit to the same degree the input to the receiver of "wanted signal." This is a disadvantage in the case of some domestic installations where pick-up on the lead-in is relied upon to ensure a satisfactory signal. Furthermore, such transmission systems introduce other losses of signal due to inherent imperfections of impedance-matching of the transformers for other than a particular band of frequencies, as well as to conductor and dielectric losses.

In all cases where the loss of signal strength from the above causes necessitates the operation of the receiver at relatively high gain, the consequent increase of receiver background noise may prove disadvantageous.

Dependence upon the Electrical Engineer

It will be clear from the foregoing that even with screened receivers and specially designed transmission lines, unless the aerial can be placed outside the field of interference, real elimination cannot be effected. The application of the principles previously described are, however, of special value in some cases, especially where the cost of their elaboration is justified. They have been utilised, for example, in the design of special aerial systems for use in the demonstration of the performance of radio receivers in large departmental stores. In such cases a large proportion of the interference is local in character, and the system, as already pointed out, is primarily suited to this circumstance. Another example is the large apartment building where a single well-designed aerial, elevated well above the roof of the building, can, by means of a radio frequency distribution system, embodying radio-frequency amplifiers, be made to furnish adequate pick-up for as many as 3,000 apartments, special provision being made to prevent interaction between the receivers.

In conclusion, it is desired to emphasise that in presenting this account of the efforts made by the radio engineer to help himself in this matter of electrical interference, there is no adversely critical intent in pointing out to the manufacturer as well as to the listener that, in the opinion of the author, the radio engineer's contribution is necessarily limited, that it can achieve only amelioration of the conditions, and that the complete and only satisfactory solution of the problem rests with the suppression of electrical interference at the source—this has yet to be accomplished.

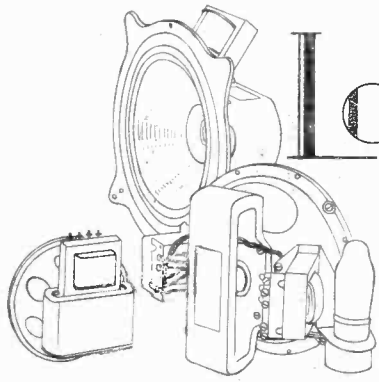

LOUD SPEAKER TENDENCIES

The Season's New Types at Olympia

THE small moving-coil loud speaker unit continues to hold its popularity with set manufacturers and home constructors, and, as far as the number and variety of makes are concerned, is well ahead of any other type. Units with permanent magnet fields are most in evidence, as they are readily adaptable to receiving sets of every type.

Research still continues in the direction of approaching the efficiency of the energised field magnet without unduly increasing cost, and there can be no doubt that a definite improvement has been achieved in the total flux energy provided for a given price. The composite class of magnet in which a cobalt steel centre pole is used in conjunction with a chrome steel yoke has proved very popular, and there is a continued demand for the two-claw type of magnet. Instead of the

A cylindrical type permanent magnet is used in the Ormond Type R494 loud speaker.

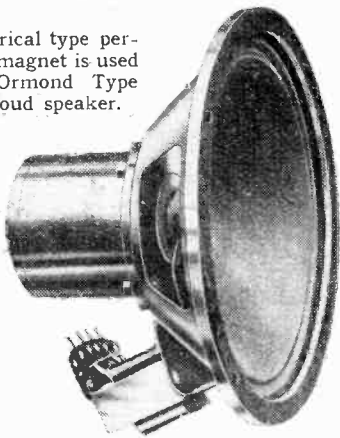

forged bar method of construction adopted last year, however, the body of the magnet is now cast with an integral top plate, so that the proportion of soft iron is reduced to that required for the centre pole. After manufacturing a considerable number of magnets of both these types, Messrs. Darwins, Ltd., have found that they lend themselves to a considerable improvement in the matter of ageing.

While on the subject of magnet design, it is interesting to note that a return to the cylindrical pot type of magnet has been made with considerable success as regards efficiency, reliability and low price in the Ormond Type R494 units.

In the early stages of the development of the small permanent magnet unit some trouble was experienced in providing sufficient mechanical rigidity to ensure reliability as regards freedom of the moving coil in the air gap. To overcome this trouble two courses are open to the

designer. Either he may increase the air gap to give wider clearances, in which case a larger and more expensive magnet will be required, or the narrow air gap

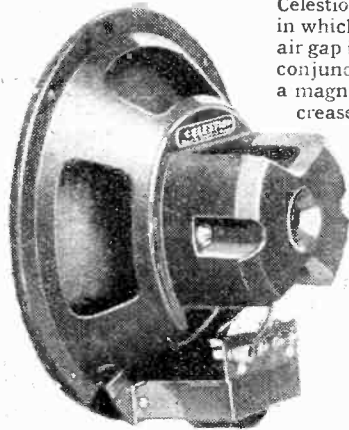

Celestion PPM19 in which a wider air gap is used in conjunction with a magnet of increased size.

may be retained and special precautions taken to ensure lateral rigidity and accuracy of alignment.

Celestion, Ltd., have adopted the former course in their PPM9 and PPM19 permanent magnet units. The extra cost of the magnet, however, has been offset by improved methods of production, so that prices show no increase over last year's figures. Lateral rigidity has been increased by an improved design of

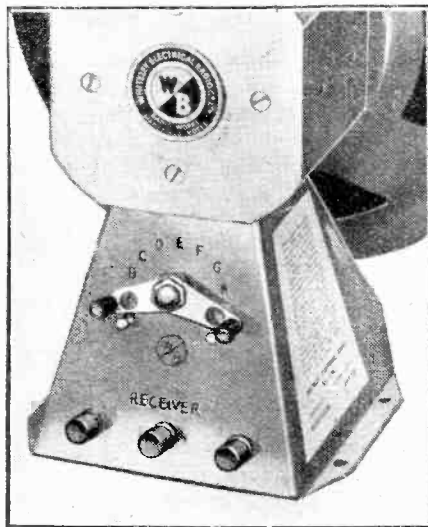

Fine adjustment of the output transformer ratio is provided in W.B. "Microlode" loud speakers.

centring spider and to prevent the ingress of filings and other extraneous matter to the air gap the fields are magnetised after the unit has been assembled.

In the new R, and A. "Alpha" unit special attention to the method of aligning the diaphragm and moving coil has made practicable the use of exceedingly small clearances. It has been customary

for the diaphragm supporting member to be called upon to take also the weight of the field magnet, but in the new R. and A. design a separate pressed member located by a bush on an extension to the centre pole of the magnet supports the diaphragm both at its surround and apex to an accuracy of the order of 0.0005in. Not only is the diaphragm system independent of any damage which may occur to the outer frame of the unit, but there is the additional advantage that if necessary the diaphragm assembly may be removed for inspection or cleaning without fear of upsetting the alignment.

Another step in the direction of insuring the purchase against loss due to

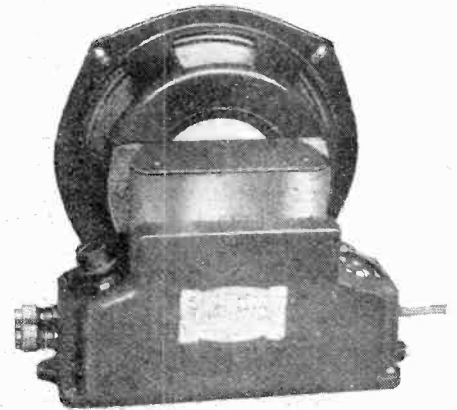

Sonochorde Class "B" loud speaker unit.

mechanical or electrical failure has been adopted in the case of the new Magnavox permanent magnet moving-coil loud speakers which are supplied in a sealed dust-proof bag and carry a guarantee for one year provided that the seal is unbroken.

Universal output transformers have in most cases been extended in scope to make them suitable for connection to push-pull outputs of the Class "B" and Q.P.P. Units without transformers, for use as extension loud speakers, are also being supplied in large numbers.

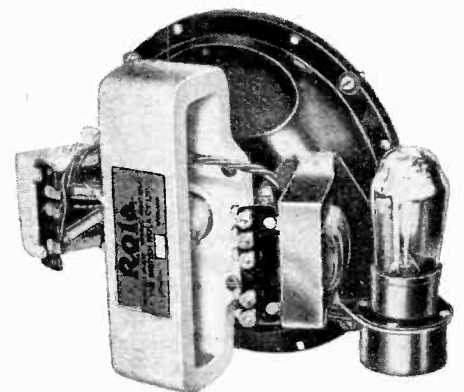

Rola Class "B" speaker amplifier unit.

Loud Speaker Tendencies—

Exceptionally accurate matching with the output stage is possible in the new W.B. "Microlode" loud speaker. In all, seventeen alternative ratios are available,

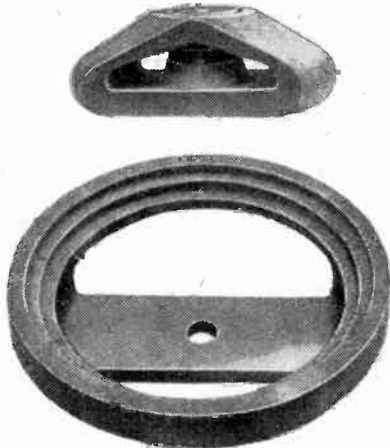

Swift Levick magnets for portable set and car radio loud speaker units.

and the required value is rapidly selected by a switching system incorporating two arms. Not only does this system enable the maximum efficiency to be derived from the loud speaker output stage combination but it is also possible, by choosing ratios adjacent to the optimum, to modify the quality of reproduction for special requirements. The system is equally adaptable for single power output valves and Class "B" or Q.P.P. amplification.

Another unit of more than usual interest is the latest "Earl" moving-coil loud speaker, in which a volume control is incorporated between the secondary of the

speech transformer and the moving coil. This takes the form of a low-impedance potentiometer connected in such a manner that the sensitivity at full volume is not impaired, and that there is no loss of the higher frequencies at the lower end of the volume range. When the control is turned to the minimum position the moving coil is automatically disconnected, an arrangement which is of great advantage where an extension

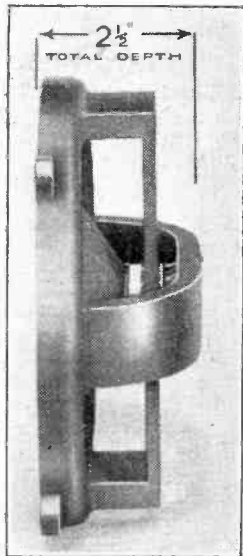

Goodmans "Auto" car radio and portable permanent magnet loud speaker.

loud speaker is used.

Loud speaker units incorporating a complete Class "B" stage with driver and output transformers are now being produced by the majority of manufacturers. These units are ready for attachment to the output terminals of existing receivers, when the power valve automatically becomes the driver valve for the Class "B"

stage. The addition of one of these units to an obsolete battery set will result in a remarkable improvement in volume and quality without putting a prohibitive load on the H.T. battery.

Car Radio Units

Miniature moving-coil units have received a considerable impetus from the new vogue of car radio receivers. There is also a definite tendency towards the employment of loud speakers of this type in portable sets. In both cases space is of prime importance, and the overall depth from back to front must be kept as low as possible. The magnet manufacturers have not been slow in producing special types for this purpose, and two examples made by Swift, Levick and Sons, Ltd., serve to illustrate this trend. In one case the magnet is designed to fit inside the cone and to work with a re-entrant moving coil, and in the other the magnet system is circular and serves also as a supporting ring for the periphery of the diaphragm.

The Goodmans "Auto" loud speaker is an example of the form of construction in which the whole of the chassis is included in the magnetic circuit. It has an overall diameter of 6 3/4 in. with a maximum depth of only 2 1/2 in.

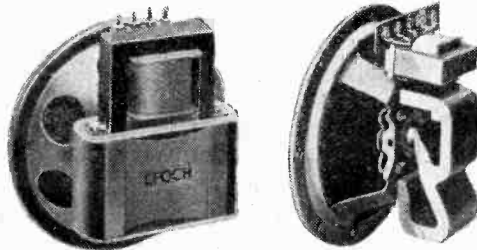

Epoch "Super Dwarf" unit.

Amplion "Sonette" miniature loud speaker.

The new Sonochorde "Baby Midget" loud speakers employ a more conventional magnet system, but do not occupy any more space from back to front, and the diaphragm diameter is only 4 1/4 in. (5 in. overall). Another example of special construction in the interests of a reduction of depth is to be found in the Grampian

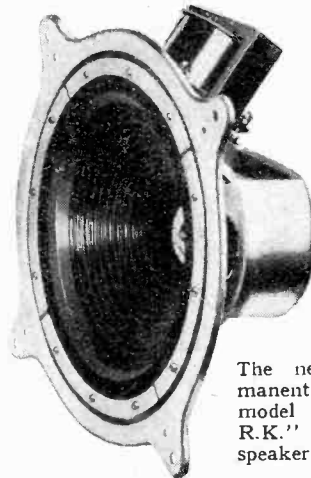

The new permanent magnet model "Senior R.K." loud speaker chassis.

"Owl" energised unit in which the field core is wound as a flat slab not unlike a section of a power transformer, while the Amplion "Sonette" is notable for

the compact and efficient design of its permanent magnet.

At the other extreme the "super" type

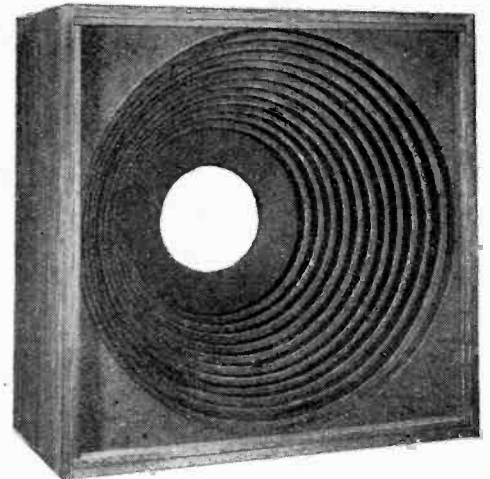

Osborn non-resonant box baffle.

of moving-coil loud speaker for superlative quality of reproduction is well represented this year, and firms such as the G.E.C., Baker Selhurst, Ferranti, Epoch, and B.T.H. have again catered adequately for this market.

The performance of a loud speaker is affected considerably by the type of baffle with which it is used. The box baffle has become deservedly popular on account of its compactness in relation to the effective area, but it is now fully realised that adequate precautions must be taken to eliminate internal reflections which give rise to accentuation of frequencies in the region of 150 cycles. The trouble is overcome by filling in the corners of the box, and in

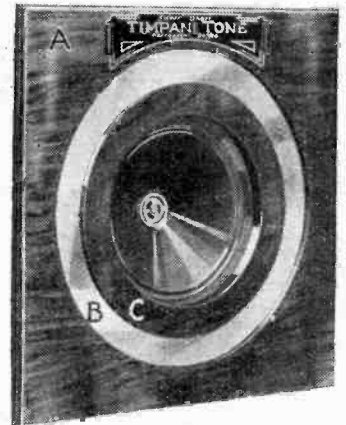

Lamplugh "Timpani Tone" baffle. (A) Laminated outer frame. (B) Sheet metal ring. (C) Inner mounting ring.

the new box baffle shown by Chas. A. Osborn a sound-absorbing material made from pulped sugar-cane is used, and is built up to form a succession of stepped rings of gradually increasing diameter.

Another baffle which is likely to attract a good deal of attention is the "Timpani Tone," of Lamplugh Radio, Ltd. This includes a ring of heavy-gauge rolled copper, approximately 3 in. wide, surrounding the loud speaker diaphragm, and it is claimed that a definite tone, which can be controlled by altering the area or the metal of the membrane, is given to the general reproduction.

THE NEW VALVES



SO rapid has been the development of the multiple-valve that it is still customary to think of it as a rarity and something of a curiosity. It comes as a surprise, therefore, to find that practically every valve firm is exhibiting at least one type. The duo-diode-triode is the most usual, and it consists essentially of three separate valves—two diodes and one triode— assembled in a single glass envelope with a common cathode and fitted to a seven-pin base.

The chief purpose of this valve is for providing signal rectification, delayed automatic volume control, and L.F. amplification in a simple and inexpensive manner. Generally, one diode is used as a detector for demodulation purposes,

The Show Portrays the Growth of the Multiple-valve.

and the A.C. model is by far the commonest. The Ferranti H4D, the Marconi MHD4, the Mazda AC/HLDD, the Osram MHD4, the Six-Sixty 4DDTAC, and the Micromesh and Mullard specimens are all of the A.C. type, but Marconi and Osram have a D.C. model, the DHD, with a heater rated at 20 volts 0.25 ampere, and Mullard have a type with a heater designed for operating at 25 volts 0.18 ampere.

In the battery range Mazda are showing the first battery duo-diode-triode, the L2DD, the triode portion having an A.C. resistance of 10,000 ohms with a mutual conductance of 1.6 mA/V.

Mullard have also a single-diode-tetrode in their A.C. range, and, as its name implies, this consists of the combination of a single diode with a screen-grid valve. Although the primary purpose of this valve is to replace the ordinary screen-grid detector, it is by no means improbable that one of its chief applications will be found in conjunction with the duo-diode-triode to provide quiet delayed automatic volume control.

The Cossor multiple-valve is a duo-diode-pentode, the pentode portion being a screened variable-mu pentode. The diode system is intended to give signal rectification with delayed A.V.C., but the bias voltages are also applied to the control grid of the pentode which acts as the first L.F. amplifier. A.V.C. thus operates on both pre-detector and post-detector stages, and it is claimed that this results in a practically perfect control.

Class "B" Ranges

No description of multiple-valves would be complete without the inclusion of the Class "B" types, for these really consist of two triodes mounted in the same bulb. In most cases they are operated with zero grid bias, and their chief virtue is extreme economy in battery power while providing quite large volume with good quality. Cossor have two types, the 220B, rated for an output of 1 watt, and the 240B, rated for 2 watts, while Ferranti, Mullard, and Six-Sixty all list specimens. The Mazda PD220 is unusual in that it is operated at zero bias with normal anode voltages, but requires a very small negative grid

bias when its full rated voltage is applied. The B.21 type of both Marconi and Osram, however, requires an appreciable bias with all anode voltages, and under its maximum rated conditions it needs from 4½ to 6 volts, and it is then capable of an output of 2 watts. These valves are claimed to have an unusually high input impedance and to be free from parasitic oscillation.

Turning from the multiple types, we find a new class of multi-electrode valves, the foremost of which is undoubtedly the Ferranti Heptode, for it has no less than seven electrodes. The valve is of the Pentagrid type, and fulfils the functions of a variable-mu first detector valve and a separate triode oscillator for superheterodyne frequency changing purposes. Next in order come the H.F. pentodes. These are essentially similar to the ordinary screen-grid types, but include an additional electrode, the chief function of which is to increase the voltage handling capacity of the valve. As a result, overloading is less likely to occur than with older valves, and the benefit of this change is most noticeable in a battery set where the H.T. supply is usually limited. So far the variable-mu battery

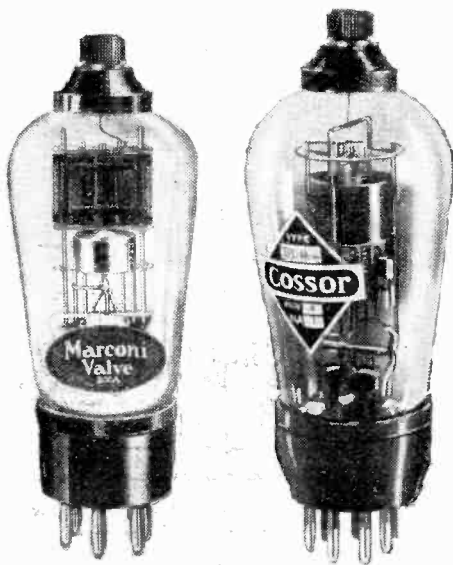

Marconi MHD4 duo-diode triode.

Cossor DD/Pen. duo-diode triode.

and the other as an over-biased rectifier for providing the biasing voltage for delayed A.V.C., while the triode acts as a simple first stage L.F. amplifier. Many variations are possible, however, and the two diodes may be used to give push-pull detection with or without simple A.V.C.; alternatively, one diode may give signal rectification and produce the steady voltage for biasing purposes, while the triode acts as an amplifier of both the L.F. voltages and the D.C. potential and the other diode provides the necessary delay action—this system is known as delayed amplified A.V.C.

Although a common cathode is provided for the different sections of the valve, the diode anodes are screened from the triode assembly and the grid connection of the latter is brought out to a terminal at the top of the bulb in order to minimise common coupling between the different circuits. So far the duo-diode-triode is available chiefly in mains types,

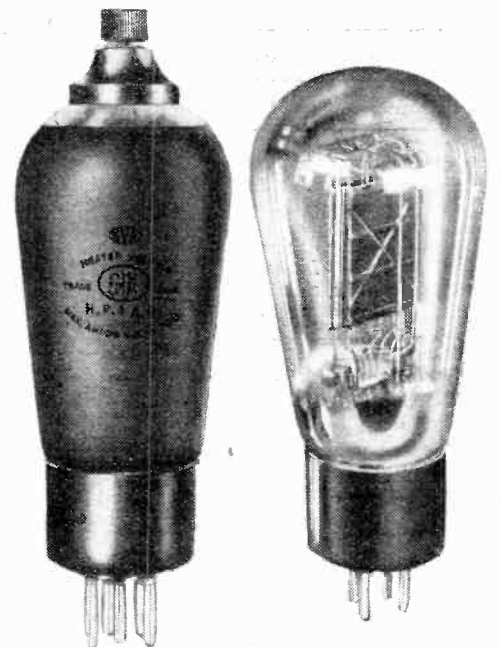

Six-Sixty HP1 A.C. H.F. pentode.

Mullard DO.26 output triode.

H.F. pentode has appeared only in the Marconi and Osram ranges.

Cossor, Ferranti, Marconi, Mazda, Micromesh, Mullard, Osram, and Six-Sixty all have H.F. pentodes in their A.C. mains ranges, and most firms are marketing them in both ordinary and variable-mu types. The latter is the more generally useful for amplification purposes, of course, and the non-variable-

The New Valves—

mu models are chiefly for detector-oscillators and detectors. Most firms, too, are now making indirectly heated rectifier valves for the H.T. supply.

The introduction of Class "B" working has given a new lease of life to the battery set, and so stimulated improvements in battery valves. Both Marconi and Osram have introduced several low consumption screen-grid valves, and the 362 Radio Valve Co. are showing the "Toledo" range of unbreakable battery valves with a metal construction. In the A.C. type Marconi and Osram Catkin valves now replace the ordinary types of the same list numbers, but have not yet been further extended.

Mullard have brought out a large triode output valve, the DO26, rated for 400 volts and rated for 25 watts anode dissipation, while Marconi and Osram have a 16 watts pentode, the PT16, which is of the directly heated type. Mazda have a new pentode rated for 250 volts anode and screen supplies which is capable of giving an output of nearly $3\frac{1}{2}$ watts with a signal input of only 2.6 volts R.M.S. This is the type A.C.2/Pen.

Although not strictly speaking valves, the Westinghouse metal rectifiers are conveniently classed as such, since they can replace the diode for signal rectification and A.V.C. purposes. Two types are available, each in a single or push-pull model, with different input voltage ratings.

It will thus be apparent that there are two distinct trends visible in valve de-

sign—that towards multiple valves, and that towards multi-electrode valves. The former is exemplified by the combination diode types and the Class "B" valves, whereas the latter is brought out in the Heptode and pentode types. Each system may have its practical merits, but

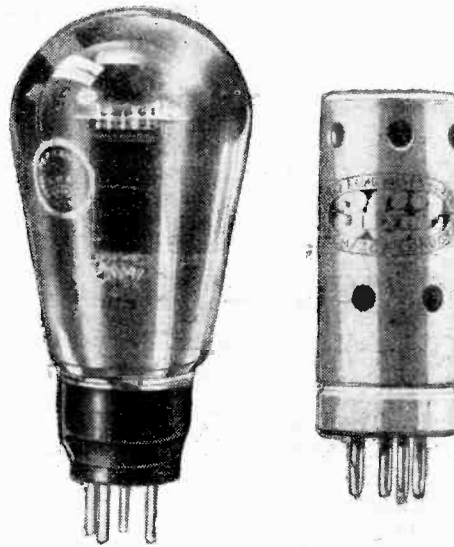

Ferranti LP4
2½-watt triode.

362 Toledo
battery valve.

there is no doubt that the multiple-valve is less interesting technically than the multi-electrode type, for it may always be replaced by a suitable number of ordinary valves, and it involves no new principles. The multi-electrode valve, however, represents a distinct advance, for its performance cannot be duplicated by any combination of ordinary types.

READERS PROBLEMS

THESE columns are reserved for the publication of matter of general interest arising out of problems submitted by our readers. Readers requiring an individual reply to their technical questions by post are referred to "The Wireless World" Information Bureau, of which brief particulars, with the fee charged, are to be found at the foot of this page.

L.F. Coupling Units

A READER has a parallel-fed transformer coupling unit, in which the internal connections are inaccessible; he wishes to use the unit with a value of coupling resistance differing from that included in it.

There is no objection to doing this, and it does not follow, as our correspondent seems to think, that the characteristics of the unit will be impaired by using an external resistance. If it is desired to use a feed resistance of lower value than at present, it might be more convenient to connect an external shunt resistance of such a value that the two, in parallel, are equal to the desired resistance.

5-metre Reception

A USER of the Ultra Short Wave Two (described in *The Wireless World* of June 16th) finds that, although sensitivity is good, there is a tendency for reception to be marred by what he describes as a "rushing" noise. This is present even when the controlling resistance R2 is "all in."

Here we have a fairly certain indication that the detector H.T. voltage employed is unduly high. It will be found that some valves work best with a low anode potential—even lower than was recommended in the original article.

Another query relating to the same set deals with the adjustment of the small semi-variable condenser C1, which is inserted (electrically) at the mid-point of the tuning coil. The adjustment of this condenser, though not difficult, is fairly critical. Being in series with the tuned circuit, its capacity has an effect on the tuning range covered; if the capacity be too high, the 5-metre wavelength may be unreceivable, or at any rate will come too near to the zero point of the tuning condenser. On the other hand, the use of too low a capacity in this position will make it impossible to produce self-oscillation.

Loss or Gain?

A DIODE detector, plus an L.F. stage, is roughly equivalent in sensitivity to an ordinary grid detector alone. This will serve as an answer to a correspondent who proposes to change over to diode detection, but a few words of qualification may be added.

When the original set included no provision for reaction, the substitution of a diode should lead to noticeably improved sensitivity and selectivity. This is not because the actual rectification efficiency of

the diode is higher, but because reversed reaction will no longer be present.

With the help of reaction, on the other hand, the out-of-phase feed-back effect in a grid detector may be neutralised, and extra sensitivity added as well. In this case, the substitution of a diode (without reaction) will lead to a reduction in the effective range of the set.

Low Anode Volts

WRITING on the subject of his Class "B" Ferrocart receiver (*The Wireless World*, April 7th), a reader states that the voltage on the detector anode, as measured by a high-resistance meter, amounts to less than 10 volts. He goes on to ask whether this would account for the fact that sensitivity is low, and it is impossible to obtain proper reaction effects.

A good deal depends on the interpretation of the expression "high resistance" as applied to the meter, but if our querist's instrument is a good one the measurement he has made would indicate definitely that there is a defect in the anode circuit of the detector valve. This defect might take the form of a partial short-circuit, or an excessively high series resistance. Short-circuits might exist in the reaction condenser, the anode by-pass condenser C9, or in the decoupling condenser C10. An excessively

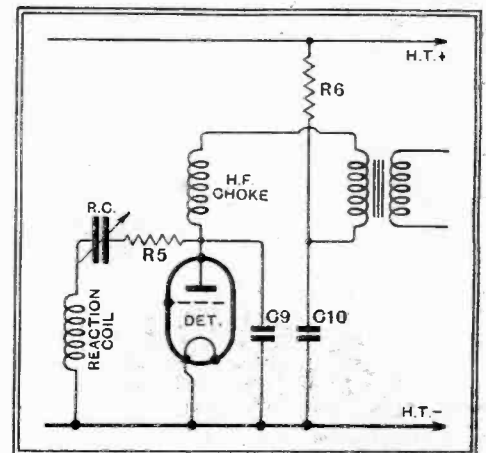

Fig. 1.—The detector anode circuit of the Class "B" Ferrocart receiver.

high series resistance might be found in the H.F. choke, the transformer primary winding, or, more probably, in the decoupling resistance R6. A part of the original circuit diagram is reproduced in Fig. 1.

As the decoupling resistance R6 is of a fairly high value, it is natural that the voltage on the anode should read low with any meter, but with a good instrument at least 20 or 30 volts.

The Wireless World INFORMATION BUREAU

THE service is intended primarily for readers meeting with difficulties in the construction, adjustment, operation, or maintenance of wireless receivers described in *The Wireless World*, or those of commercial design which from time to time are reviewed in the pages of *The Wireless World*. Every endeavour will be made to deal with queries on all wireless matters, provided that they are of such a nature that they can be dealt with satisfactorily in a letter.

Communications should be addressed to *The Wireless World* Information Bureau, Dorset House, Stamford Street, London, S.E.1, and must be accompanied by a remittance of 5s. to cover the cost of the service. The enquirer's name and address should be written in block letters at the top of all communications.

The Wireless World

THE
PRACTICAL RADIO
JOURNAL
23rd Year of Publication

No. 730.

FRIDAY, AUGUST 25TH, 1933.

VOL. XXXIII. No. 8.

Proprietors: ILIFFE & SONS LTD.

Editor:
HUGH S. POCOCK.

Editorial,
Advertising and Publishing Offices:
DORSET HOUSE, STAMFORD STREET,
LONDON, S.E.1.

Telephone: Hop 3333 (50 lines).
Telegrams: "Ethaworld, Watloo, London."

COVENTRY: Hertford Street.

Telegrams: "Cyclist, Coventry." Telephone: 5210 Coventry.

BIRMINGHAM:

Guildhall Buildings, Navigation Street, 2.
Telegrams: "Autopress, Birmingham." Telephone: 2970 Midland (3 lines).

MANCHESTER: 260, Deansgate, 3.

Telegrams: "Iliffe, Manchester." Telephone: Blackfriars 4412 (4 lines).

GLASGOW: 26B, Renfield Street, C.2.

Telegrams: "Iliffe, Glasgow." Telephone: Central 4857.

PUBLISHED WEEKLY. ENTERED AS SECOND
CLASS MATTER AT NEW YORK, N.Y.

Subscription Rates:

Home, £1 1s. 8d.; Canada, £1 1s. 8d.; other
countries abroad, £1 3s. 10d. per annum.

As many of the circuits and apparatus described in these
pages are covered by patents, readers are advised, before
making use of them, to satisfy themselves that they would
not be infringing patents.

CONTENTS

	Page
<i>PROGRAMMES FROM</i>	
<i>ABROAD, pp. I—XXIV</i>	
<i>Editorial Comment</i>	149
<i>Fog Landing by Wireless</i>	151
<i>Notes on the Modern Battery Four</i>	153
<i>Short Waves on the River</i>	155
<i>Unbiased</i>	156
<i>Olympia's Story</i>	157
<i>Modulated Pentode Oscillator</i>	183
<i>News of the Week</i>	184
<i>Ultra Short Wave Record</i>	185
<i>Broadcast Brevities</i>	186
<i>Marconiphone 260 Receiver</i>	187
<i>Letters to the Editor</i>	188

EDITORIAL COMMENT

The Show

Some General Observations

AS one Show succeeds another year by year, it is always of interest to try to sort out from amongst the mass of new impressions received what are really the outstanding influences of a general character which make each Show differ from its predecessor.

The Olympia which has just closed its doors maintained the tradition in being undoubtedly better than any of its predecessors. In the matter of the arrangement of the Exhibition notable improvements have been made; gangways were wider—a point which may seem trivial but is actually of the greatest importance when you visit the Show, especially at crowded times, for it enables you to get about and to see stands without inconvenience. Exhibitors, too, either through better organisation or as a result of the experience which their personnel has gained, were able to give better attention to the enquiries of the public. This impression was gained as a result of standing by and watching the procedure at a number of stands.

Interest in Foreign Programmes

On the technical side one was impressed with the extraordinary increase in the number of sets designed for extreme sensitivity and selectivity, and superheterodynes undoubtedly predominated amongst sets of a type which could be described as new. These sets of extreme sensitivity can scarcely be regarded as necessary for the reception of the B.B.C. programmes alone, because now that alternative programmes are becoming a rarity in the B.B.C. policy, selectivity and sensitivity of a very high order is scarcely necessary for their reception, except in areas rather remote from a B.B.C.

transmitter; so that we can at once assume that the reason for these sensitive and selective sets is the increasing desire on the part of the public to be able to regard all Europe as a source of programmes, and undoubtedly to-day the need for alternative B.B.C. programmes is less than it has ever been in the past, by reason of the power and efficiency of the majority of the Continental transmitters which offer a constant choice of programme material at excellent strength and quality.

Quality and Price

One tendency at the Exhibition gives us cause for a little uneasiness, not perhaps in respect of this year's models so much as because of what might lie before us for next season. We refer to the attempt of nearly all manufacturers to bring down their prices to what we regard as almost a dangerous figure. From the public's point of view we are, of course, entirely in favour of wireless sets being obtainable as cheaply as possible, but this cheapening must never be allowed to result in a lowering of the standard of quality of reception. There is not, fortunately, this year much indication that manufacturers have sacrificed performance to price, but we believe that the limit has just about been reached and, since we are ourselves determined to do everything in our power to prevent a sacrifice in performance, and especially of quality, in future designs, we believe that the sets of this season will never again be equalled in value. Almost certainly there will be a rise in prices with next season's sets, except, perhaps, in the case of those manufacturers who will be shortsighted enough to continue a policy of cheapening and put out sets which can only be a disappointment to unfortunate purchasers. All this leads us to the logical conclusion that anyone who is wavering on the question

of the purchase of a set will find that it is an investment to make a careful choice and buy this season.

The Rival Show

Returning to the Show itself, an innovation this year was the B.B.C. theatre and variety performance, which gave the visitor an insight into what goes on behind the scenes in the studios. This was a departure which we venture to prophesy will not be seen again in connection with a wireless show. It has been an interesting experiment, but one which, in our view, in spite of the fact that the fullest credit is due to the B.B.C. for the excellent way in which it was conducted, and the enterprise shown in arranging for it, was undoubtedly a mistake. The theatre, built especially for these performances, which were given three times a day, accommodated some 2,000 spectators, and, since it was widely advertised and made a popular appeal, the attendance in the Olympia Show itself suffered badly in consequence. Visitors attending Olympia who gained admission to the B.B.C. theatre had little time to see anything else, to the considerable discomfiture of those exhibitors who had incurred heavy expenditure in anticipation of a constant stream of visitors to their stands.

Again, broadcasting, by its very nature, appeals to the ear, and it is, in our opinion, a bad advertisement for broadcasting to impress upon the

listener what he is missing through inability to see the performance as given before the microphone. We have constantly in the past expressed the view that the B.B.C. should have no other approach to the public than through the medium of broadcasting.

grammes by the listener through the medium of his set. The B.B.C. theatre at Olympia cannot be regarded as having been anything but a most serious rival to the success of the Olympia Radio Show. When television has developed to the point where



The Wireless World stand at Olympia as it appeared just before public admission to the Show.

We have repeatedly expressed our disapproval of the B.B.C. running their own Concert Hall as at present in Broadcasting House, or, in fact, adopting any policy whereby the public is entertained by means other than the monopoly of broadcasting granted to the B.B.C. and enjoyment of the pro-

it is of definite entertainment value, then broadcasting will be able to combine sight and sound in the listener's receiver as a legitimate combination coming within the scope of the B.B.C.'s activities.

Television

On the subject of television we should mention as of special interest the fact that television sets for the present thirty-line transmissions of the B.B.C. were shown at Olympia. These are no longer experimental sets but can be recommended to the public as being capable of receiving television in its present state satisfactorily. Not until now have we been prepared to make a statement of this kind, but here are sets on the mirror-drum principle developed by the Baird Company which, in our view, from practical experience, do full justice to the present transmissions, bearing in mind, of course, that these thirty-line transmissions are limited in the definition which they can give. So that whilst they are of the utmost interest as indicating possibilities of television and giving pictures of the performers of surprising clearness, the transmissions themselves would probably not be regarded as having yet reached a point where they are of real entertainment value capable of sustaining the interest of those who are merely interested in results.

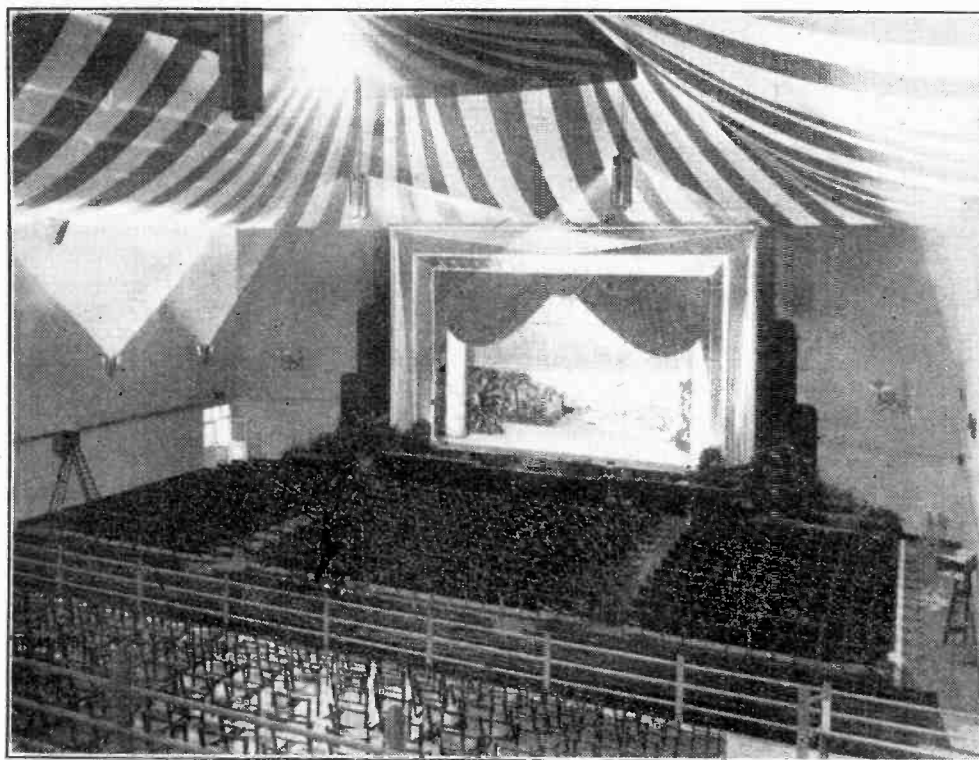

The B.B.C. Theatre at Olympia built specially for the Show and accommodating some two thousand spectators.

Fog Landing By Wireless

Ultra Short Waves at the Aerodrome

(By a New York Correspondent)

ONE of the great hazards in aircraft transportation is fog. Although a pilot can follow a radio beacon course from one point to another unerringly, and although he is in constant touch with the ground by radio, getting weather reports from a great number of stations, he is still "up in the air" if he arrives at his destination in a fog.

Wireless, of such great aid to the ocean or air navigator, has now found a way to bring any properly equipped 'plane down to the ground in safety. Not long ago a radio engineer of the American Bureau of Standards left the Newark airport with his pilot for a week-end in Washington. Monday came and they were due back in Newark. But the fog between the two cities kept all aircraft on the ground.

Fog-landing, however, was the business of this engineer and his pilot. They were accustomed to it. Many times they had taken off in fog or with a covering hood over their cockpit, and had come down again safely. So they took off at once, heading up into a soupy fog which almost immediately obscured the ground beneath them.

It was not difficult to follow the radio

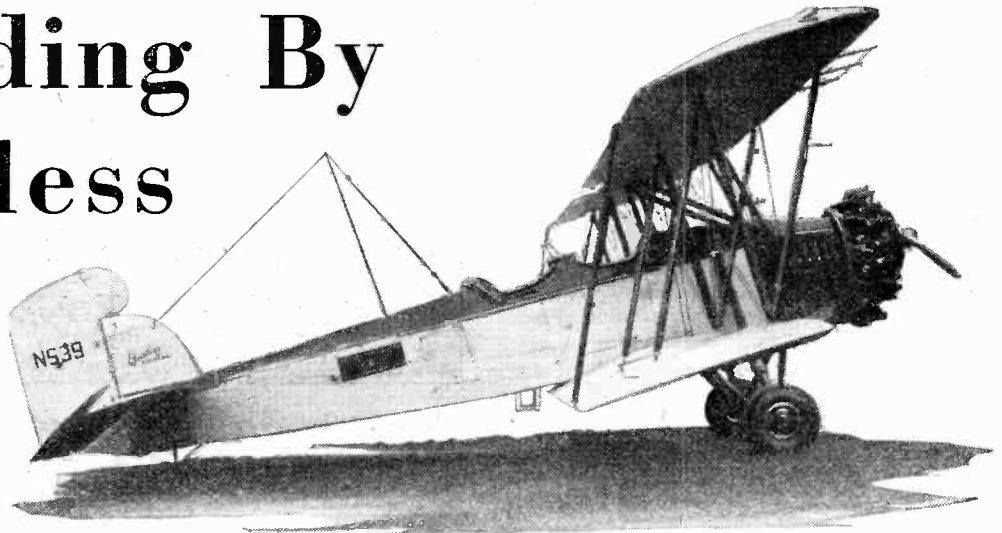

An American Bureau of Standards 'plane fitted with fog-landing radio gear as described in the article. For practice landings the pilot's cockpit is shrouded over with a canvas cover.

beacon during the three-hour flight from Washington to Newark, though, flying at 3,000 feet, they could see nothing but mist. By radio 'phone they communicated with Newark, requested that the fog equipment be turned on and that advice be given

visible radio beam) to the ground, and landed in perfect safety. Not until their wheels were nearly on the ground did their eyes perceive what their wireless equipment has told them.

It was an ideal demonstration of the fog-landing equipment which for several years has been in process of development at Washington under the immediate direction of H. Diamond. For months he had tested the system on a small field near the Capitol, and despite bad landing conditions due to a small runway, rough terrain off the runway, tall chimneys near the field, and other obstacles, had shown to the satisfaction of many pilots that blind landing could be made safe.

The next step seemed to be to show what the system could do on a large airport. So they chose one of the busiest in the world, that at Newark, New Jersey, which serves New York City.

A Path of Waves

The apparatus was moved from Washington and set up in Newark. Many new demonstrations were made. Pilots were taught to use the landing beam and to have faith in it. It now seems that similar installations will very soon be made at all of the more important airports in the United States.

The system employs ultra-short waves by means of which a path curving upward from the ground at the proper angle can be set up for the pilot to follow to the ground. A radio beacon enables him to find the airport in good weather and bad, day or night, rain or shine. If he keeps on his course—and this is not difficult—he will receive signals until he is exactly over the beacon transmitter. At the instant of coincidence with the transmitter location the signals stop. Then, by a slight retuning of the beacon receiver, he can pick up another signal, also a directive beacon, which is parallel in the ether with the physical direction of the runway on the ground. Once he has orientated his 'plane properly with respect to this new beacon he knows that the runway is

THE use of miniature beacons and vertical "walls" of signals around aerodromes is proving of practical value in combating the airman's worst enemy, fog. Here is a lively description of the ultra-short-wave installation and its manner of working at Newark, America's biggest air port.

about wind conditions, etc. When they came within range of the new radio equipment they picked up the landing path beacon, got in the proper orientation with respect to the runway and the prevailing wind, followed the curving path (the in-

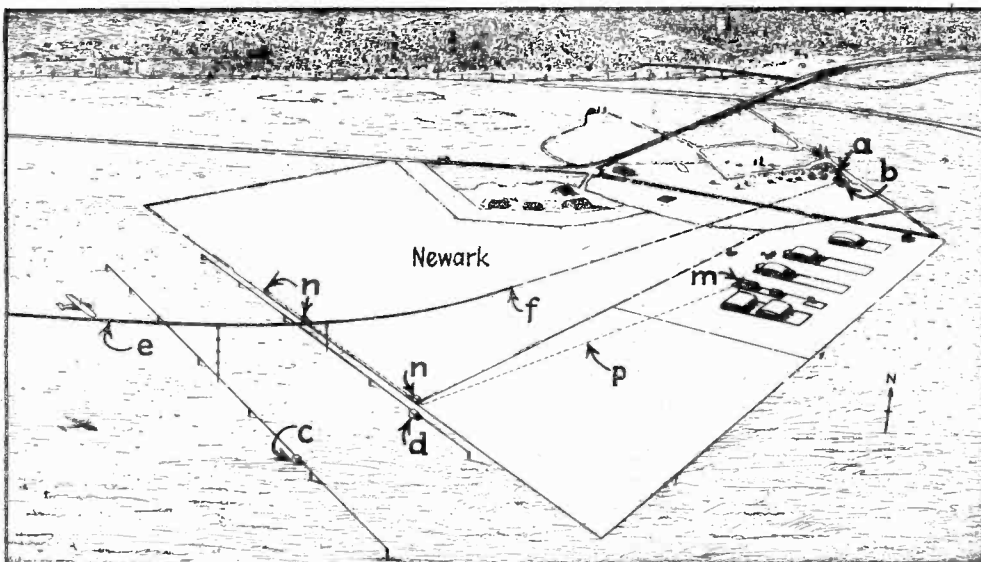

A perspective diagram of the radio layout. (a) and (b), the landing beam and runway beacon transmitters; (c) 2,000-ft. vertical marker; (d) boundary marker; (e) landing beam; (f) contact with ground; (m) headquarters and (p) communication lines.

Fog Landing by Wireless—

either directly under him or at least that he is heading into it. Since the receiver used for this purpose can be equipped with automatic volume control, in which case the grids of the h.f. amplifiers increase in bias and take less plate current as the signal becomes stronger, a plate current meter can be calibrated in miles from the air port instead of milliamperes.

Once on the runway beacon the pilot approaches the field. When he is 2,000 feet away he runs through a vertical wall of radio signals projected upward from a long, low horizontal antenna consisting of a single wire supported by posts. This vertical signal is modulated with a 1,250-cycle note. It is quite sharp, so that the pilot gets definite indication when he is directly over it. When he crosses the boundary of the field he runs through another vertical wall of signals, this one modulated

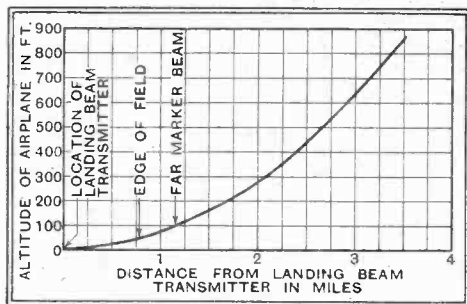

A graphic representation of the ultra-short-wave landing beam.

with a 250-cycle note.

The pilot knows now that he is not only over the runway but over the field. Therefore he can land if he can see through the fog or he can rely on the next radio device, the landing beam. This is a highly directional horizontally-polarised beam of signals on a frequency of 90,800 kilocycles (3.3 metres). This beam leaves the ground at such an angle that the pilot can follow it down without trouble or danger. If the fog is thin enough to enable him to see the ground before he reaches it he will land in the conventional manner. If it is still so thick that he cannot see the ground he will throttle down his engine and pull back the stick for a three-point landing as soon as he crosses through the wall of signals indicating that he has crossed the boundary of the field.

Since the aircraft must land into the wind, the runway beacon which he must follow on his way to the ground must be aimed in the direction of the prevailing wind blows during periods of bad visibility, or the landing runway beacon transmitter may be put underground in the centre of the field and rotated by remote control to locate the runway whenever the wind condition demands. At Newark, and probably at nearly all airports, the prevailing

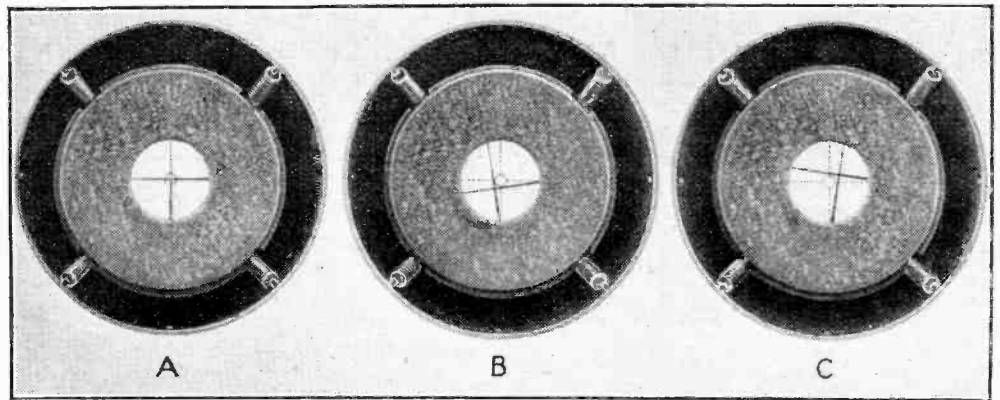

The pilot's indicating device showing the plane's position in respect of the runway and landing-beam. (A) On course; (B), below and to left of proper course; (C) Above proper course and to the right.

wind during such periods comes from one quarter, in this case from the north-east. The runway beacon transmitter is therefore located at the north-east corner of the field; by means of a goniometer the beam may be directed to any location in this quadrant.

The transmitter consists of a 200-watt, 278 kc/s oscillator modulated with two signals, 65 and 86-2/3 cycles, one signal going to each of two loop antennæ which produce a figure eight space pattern. The intersection of these patterns produces four equisignal zones. When the pilot gets out of these zones he gets a stronger

constant, he can coast downward on the directive beam.

The cost to equip an aircraft with the system is not great provided it already has the regulation radio equipment, which consists of a receiver for picking up the weather broadcasts and for two-way 'phone communication with the ground. An a.v.c. system must be added to some of the beacon receivers; the ultra-short wave receiver is essential. This is very simple. In addition, an antenna for the landing beam must be provided. The chief cost is to the airport, where the runway beacon and the landing beam must be established. The cost, however, is small compared to the usefulness of the equipment and the safety from accident or delay due to fog or bad visibility.

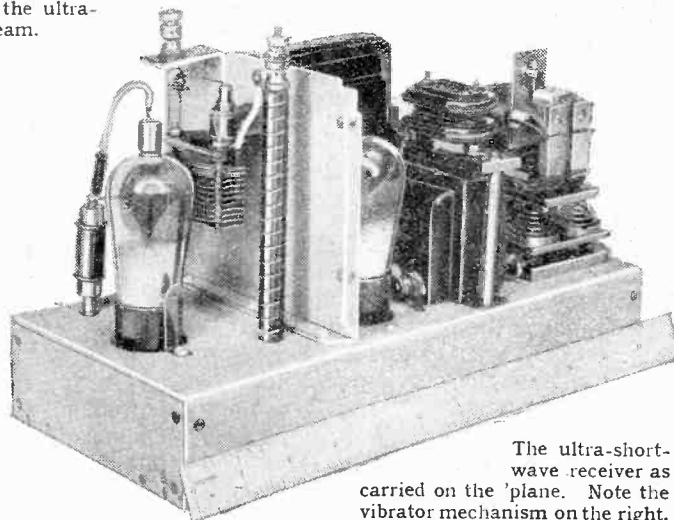

The ultra-short-wave receiver as carried on the 'plane. Note the vibrator mechanism on the right.

signal from the nearer antenna, and from his receiving instrument can tell in which direction he is getting off the course.

The beacon receiver employs two vibrating reeds tuned to the above-mentioned signals. These reeds are actuated by electromagnets in the output of the receiver, and in turn, by their vibration, induce currents in pick-up coils. These currents are rectified and applied to the pointer of an instrument which tells the pilot at a glance where he is with respect to the runway.

The high-frequency transmitter uses two 500-watt valves in push-pull connected to a directive array which sends the radiation upward at the desired angle. The receiver for this signal is very simple, containing no a.v.c. circuit, so that the pilot must act as his own a.v.c. system, and by so doing, *i.e.*, by keeping the volume output

Correct Trimming Adjustment.

WHEN the operation of trimming the various circuits of a gang-tuned receiver is carried out at random, it sometimes happens that an unnecessarily large amount of trimming capacity is used throughout. The result of doing this is, of course, to restrict the wave-range covered by the receiver.

In an attempt to overcome this disadvantage, it may be decided to begin all over again, but—such is the perversity of inanimate objects—the final adjustment is often found to be very much the same as before. To avoid this possibility, and at the same time to make sure that the original adjustment is not completely lost, it is a good plan to make a reduction in the capacities of all the trimming condensers by gradual steps. To do this, the capacity of the main condenser should be increased slightly by turning the dial in a clockwise direction for a fraction of a degree, and then maximum sensitivity should be restored by readjustment of each individual trimmer. After repeating this process several times, if necessary, one can rest assured that the circuits are properly aligned, and further, that the smallest possible amount of trimming capacity is being used.

Notes on "The Wireless World"

MODERN BATTERY FOUR

Getting the Best Out of the New Receiver

By W. T. COCKING

EVEN in the case of a simple type of receiver, the best performance cannot be obtained unless careful attention is given to detail. In this article hints are given on operating the Modern Battery Four, which was described in the issue of August 11th. Information is included on loud speaker matching and the use of a gramophone pick-up.

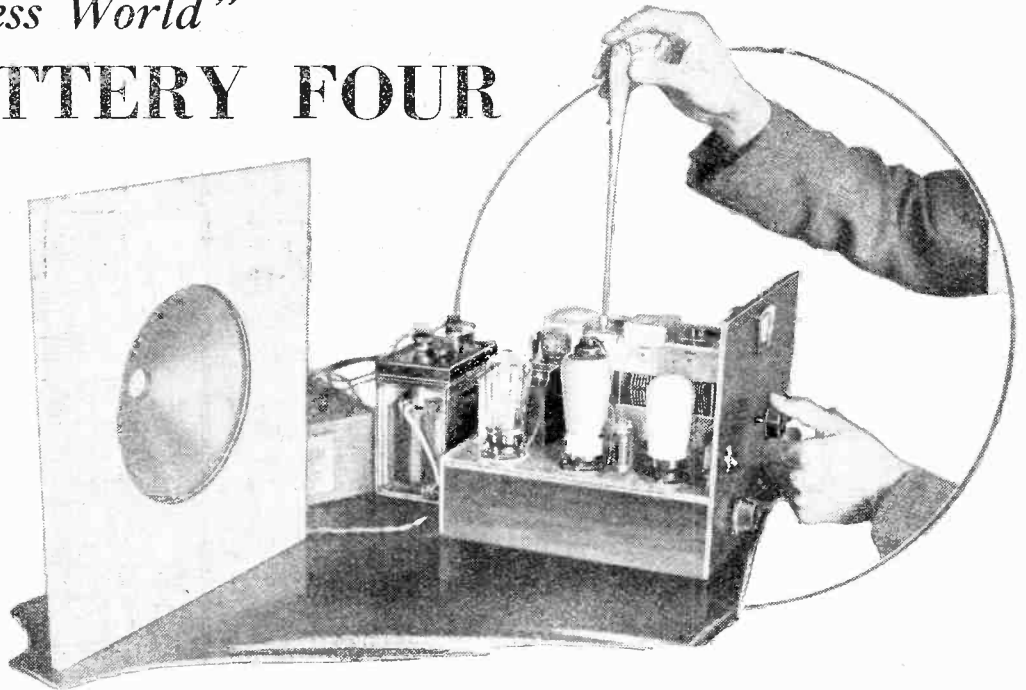

ALTHOUGH capable of giving a highly satisfactory performance, the Modern Battery Four is in no way critical, and the veriest novice should not find the slightest difficulty in obtaining good results. That all too prevalent defect of the straight set—instability—has proved on test to be entirely absent, and yet the H.F. stage gives a high degree of amplification. The sensitivity, therefore, reaches a very satisfactory order. If this is to be maintained in all cases, however, the importance of making sound earth connections to the chassis cannot be too highly stressed, for poor joints are likely to lead to unwanted couplings. A poor connection to the frame of the gang con-

denser, for instance, will almost certainly lead to common resistance being introduced into the tuned circuits with a consequent reduction in both sensitivity and selectivity, and a probability of serious instability.

Although the sensitivity obtained through the amplification of the H.F. stage is high enough for many purposes, it may be greatly increased through the use of reaction. The chief value of reaction, however, lies in its power of increasing the selectivity, although some little skill in adjustment is necessary if its full benefit is to be obtained. The primary result of applying reaction is to increase

the amplification of signals to which the set is tuned, and it does nothing directly to reduce interference on neighbouring wavelengths. Suppose, however, that we are receiving a station at comfortable loud speaker volume without reaction, but that there is interference from a neighbouring station. If now we reduce the setting of the volume control, we shall reduce all signals equally, and it is easy to find a setting such that the interference is just inaudible. Although the wanted station will now be too weak, let us leave the control in this position, and increase reaction while re-tuning slightly. This will have the result of increasing the amplification again, but this time not of all signals equally; the increase in amplification will be obtained almost entirely for the wanted station, and not for the interference.

Matching Speaker and Valve

When maximum selectivity is required, therefore, it is a good policy to use more reaction than is necessary from the point of view of signal strength, and to keep this at its correct level by means of the volume control. As reaction has some deleterious effect upon the quality of reproduction, of course, it should not be used unnecessarily, and where signal strength and freedom from interference permit, it is wise to set the control at minimum.

Although it is intended that considerable use be made of reaction in general reception, no special attempt has been made in design to obtain a smooth run into oscillation. There is no necessity to work close to the oscillation point, and the quality suffers too severely if the attempt be made; consequently, smooth reaction is a point of minor importance. The detector operating conditions, therefore, have been chosen for high quality reproduction rather than for the best reaction effects. Smooth reaction demands a high value of grid leak and a low detector

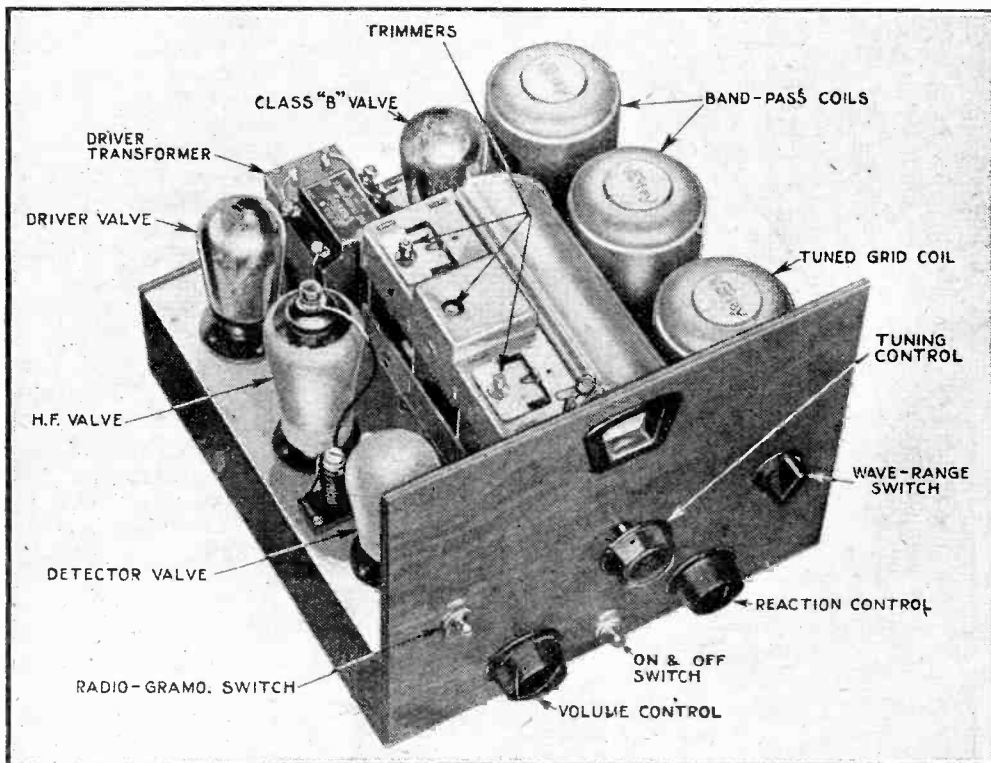

The Modern Battery Four showing the controls and the positions of the chief components. It should be noted that the H.F. valve anode lead is not screened.

Modern Battery Four—

anode voltage, neither of which is good for quality, since the high time constant in the grid circuit leads to a loss of the upper frequencies and the low anode voltage gives rise to harmonic distortion through detector overloading.

In setting up the receiver, the ganging is the most important adjustment if the full sensitivity and selectivity are to be obtained; from the point of view of quality, however, the matching of the output valve and the loud speaker must re-

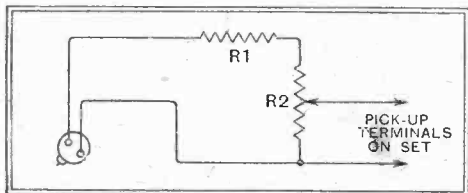

Fig. 1. The recommended pick-up connections with a sensitive pick-up. R2 should be 50,000 ohms with R1 about 250,000 ohms.

ceive careful attention. The PD220 valve specified requires a load impedance of 17,000 ohms for the best results, and a step-down Class "B" type output transformer will almost invariably be needed.

The ratio required will depend upon the impedance of the speaker and may readily be calculated by dividing 17,000 by the speech coil impedance and taking the square root of the result. Thus a 2-ohms speaker would require a ratio of

will not be directly applicable to Class "B" working, however, even if it be of the correct ratio, since its primary resistance is likely to be much too high.

Two courses are possible; the existing transformer can be dispensed with and a high ratio Class "B" type fitted instead, or the normal transformer can be retained and a low ratio Class "B" choke or transformer used in conjunction with it. Where the speech coil impedance is known, the former is the better course, since there is only one transformer in circuit to introduce losses.

It will often happen, however, that the speech coil impedance is unknown, and it is then simpler to use a low ratio Class "B" component with the ordinary transformer. If this be of the pentode type, its ratio will almost certainly

more uncertainty, but it is fairly safe to take the primary impedance as about 3,000 ohms, and an additional step-down of 2.38-1 will then be required.

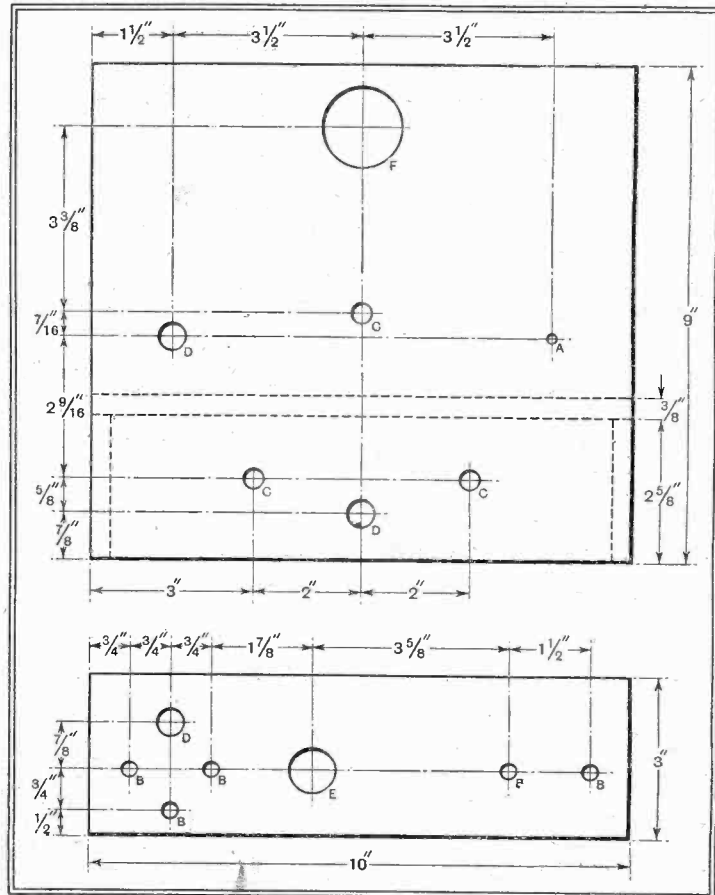

The drilling dimensions of the panel and terminal strip. The diameter of the holes are as follows:—A= $\frac{3}{16}$ in.; B= $\frac{1}{8}$ in.; C= $\frac{1}{8}$ in.; D= $\frac{1}{8}$ in.; E= $\frac{1}{8}$ in.; F= $1\frac{1}{2}$ in.

be such that the average primary impedance is about 8,000 ohms; therefore, an additional step-down ratio of 1.45-1 will be needed. Actually, of course, the nearest standard ratio of 1.5-1 would be entirely satisfactory. If the speaker be fitted with a triode type transformer there is

When using a speaker different from that specified, it may be found advisable to modify the values of R8 and C10 slightly. If the reproduction be too high pitched, R8 should be reduced in value, or C10 increased, or both; if the high frequencies are weak, of course, the reverse procedure should be adopted. It should be noted that by using a variable resistance of some 50,000 ohms for R8, a variable tone control can be fitted.

The choice of valves is by no means critical, but the H.F. valve should be of the short-base variable-mu type, otherwise a 16½ volts bias battery will be necessary. In the detector stage, any HL2 type valve may be used, but the driver should be selected according to the Class "B" valve employed. With the Mazda PD220 output valve, the L.2 driver is entirely satisfac-

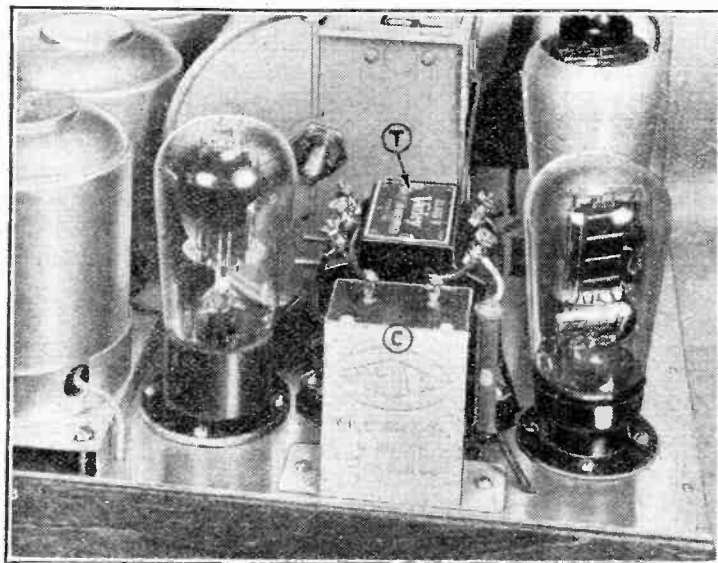

Where components other than those specified are employed it may prove necessary to change the layout slightly. The lower photograph shows the use of a large driver transformer necessitates an alteration in the position of the de-coupling condenser.

92-1, and a 20-ohms speaker a ratio of 29-1. Most speakers, however, are obtainable fitted with a Class "B" transformer of the correct ratio, but in view of the different types of Class "B" valve now available, it is important when ordering to specify the kind of valve being used.

In many cases it will be desired to use an existing speaker, and this will probably be already fitted with an ordinary pentode or triode type transformer. This

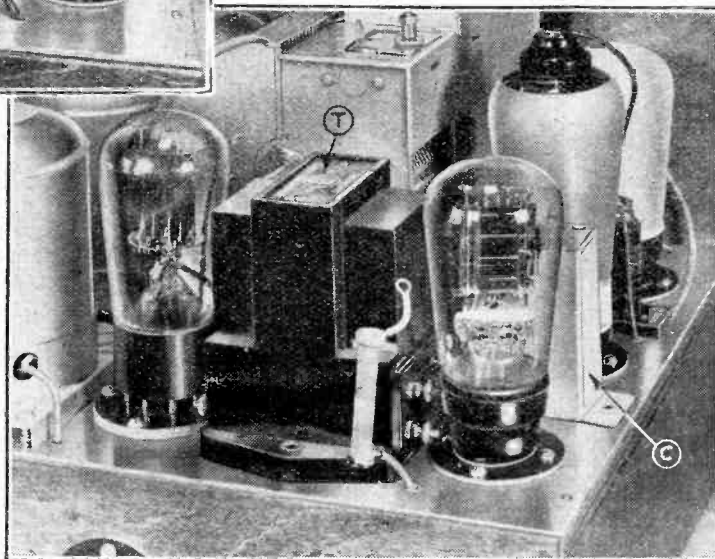

SHORT WAVES ON THE RIVER

A Canoe Station for Transmission and Reception

By R. RAVEN-HART

THE Inn and the Danube are rivers which possess such attractive scenery and so rapid a current that the canoeist usually pays little attention to anything else; nevertheless, the writer felt compelled to stop and investigate when he heard recently a voice in another canoe running over the familiar phrases used for testing telephony. This was acquaintance made with Mr. Richter, of Vienna, and his station.

Transmitter Amidships

Such a set is interesting chiefly on account of its suitability for scientific testing. With a canoe the aerial shape and height can always be the same, and the earth resistance remains unchanged,

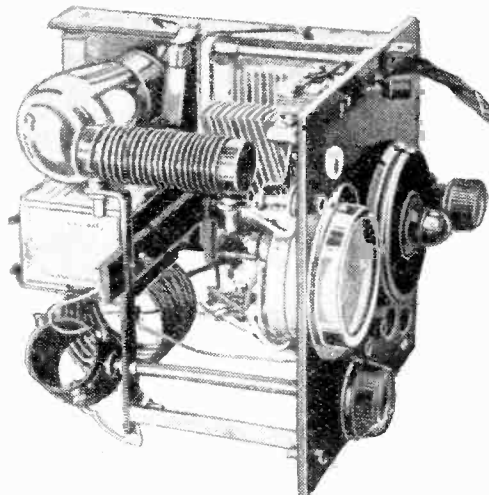

The transmitter as seen from above. An ordinary receiving valve is used.

making comparative results much more valuable than in the case of a car or other vehicle carrying radio.

As can be seen in the picture below, the transmitter and the receiver, each in its

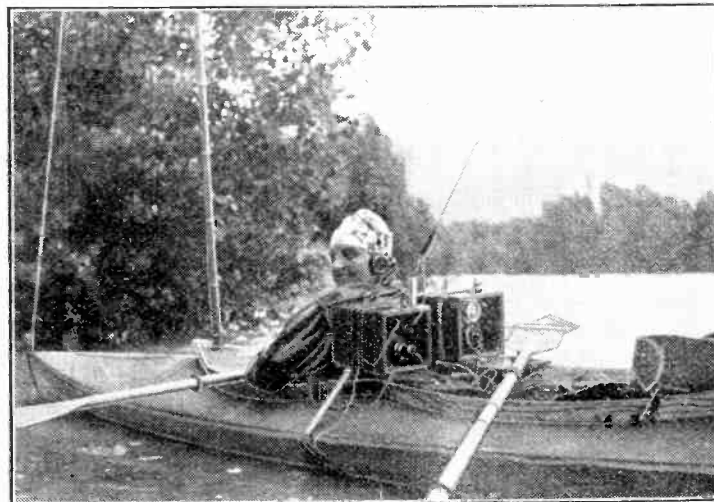

A "close-up" showing the receiver and transmitter panels, the latter being on the right.

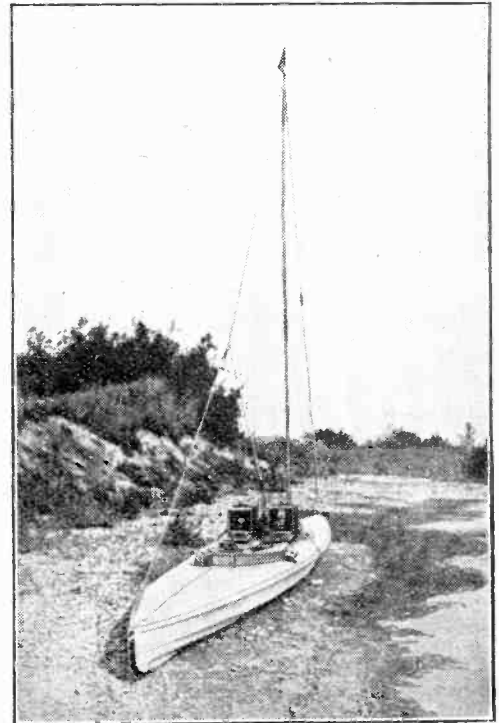

A view of the complete outfit. The wireless gear is compact but not cramped.

little wooden box, are found amidships between the two occupants, the pilot sitting in front and the operator aft. Actually, either individual can paddle or operate the wireless as required.

A Waterproof Key

The receiver uses three double-grid valves run in series to keep down the filament current, which is 60 mA. at 3 volts. The tuning coils are wound on old valve bases and are plugged in as required. Six pocket-lamp batteries are used, two in parallel for the filaments and four in series for the plates, and the transmitter plate and filament current are supplied by 120-volt and 4-volt accumulator batteries respectively, separately packed and stowed away right aft. A special waterproof key is used so that telegraphy can be carried on even in rain. The key is in its own little box, and keying is done through a thin rubber membrane.

The valve is of the normal receiving type. The "earth" is a wide belt encircling the boat with copper netting stitched to it. The wavelength in general use is 42 metres. Working on 42 metres the canoe has been heard at 500 km.

Modern Battery Four—

tory for an H.T. battery of some 120 volts, but if 150 volts be used in order to obtain a greater output, then it is advisable to use a P.220 type driver valve.

As explained in the constructional article, the Marconi and Osram B.21 Class "B" valves differ from others in that they require a negative grid bias of $4\frac{1}{2}$ volts for 120 volts H.T.; if this type be used, the centre tap of the driver transformer must be disconnected from the chassis, and joined instead to the negative terminal of the bias battery. When using different output valves, it is necessary to change the ratio of the output transformer, since the Marconi and Osram B.21 requires a load impedance of 12,000 ohms and the Cossor 240B a load of 8,000 ohms, as compared with the 17,000 ohms needed by the Mazda PD220.

The receiver may be used for the electrical reproduction of gramophone records, since Class "B" amplification permits a satisfactory performance to be obtained from a battery set. Owing to the large amount of L.F. amplification employed, the first valve is easily overloaded on gramophone, and quite a small input will suffice to give full loud speaker volume. Good results, therefore, are easily obtainable with insensitive pick-up types, and with a sensitive instrument, such as the Marconiphone, it is necessary drastically to control the input. The ordinary volume control does not give sufficient control for a sensitive pick-up, and it is recommended, therefore, that the arrangement shown in Fig. 1 be employed. The resistance R1 and the volume control R2 form a fixed potentiometer to limit the maximum input which can be applied to the first valve, and thus an adequate range of control is obtainable. The values should preferably be found experimentally for the apticular pick-up employed, but with the Marconiphone it has been found satisfactory to make R1 a quarter of a megohm with R2 50,000 ohms. Should the tone be found too high pitched, some form of tone control or scratch filter may readily be applied; it is often simplest, however, to connect a resistance directly across the terminals of the pick-up itself. Such a resistance should have its value experimentally determined, and it will usually be found to lie between 50,000 and 100,000 ohms.

TELEVISION

A Phantom Audience ?

IN our issue of June 16th, under the above title, we discussed the question of the number of users of television sets and urged the importance of arriving at some estimate of the total in the interests of everyone concerned with the development of television in this country.

Often the B.B.C. is accused of ignoring outside suggestions, but here is a case where the hint we put forward has promptly been taken by the B.B.C., and now during each transmission listeners who see the television broadcasts are urged to send a postcard to the B.B.C. All owners of television receivers should respond to the invitation.

UNBIASED

BY FREE GRID

My Show Report

IT must be confessed that at previous Olympiads love of truth and a sense of duty to my public have compelled me to give ear to and publish complaints con-



Nothing but courtesy and kindness.

cerning not only the exhibitors and organisers of the show but the exhibits themselves. You will be surprised, therefore, that of this, the eighth radio Olympiad, I write in tones of vociferous praise, albeit with a shaking hand.

Nobody connected with this year's Show—my eye sweeps from the most exalted of the commissionaires down to the humblest radio engineer—deserves less than a mighty pæan. As for the exhibits, no words can adequately express my feelings.

First I should like to pay a tribute to the personnel, whether temporary or permanent. Commencing with the attendants at the door, I was met with nothing but courtesy and kindness, in marked contrast to the harsh military treatment of former years, dealt out not only to me but to all similarly unfortunate fellow patrons who have erred in trying to pay at the turnstiles instead of at the pay desk.

As for the custodians of the stands, I can only say that my demands for technical information were met with such a flow of mathematical data that I was carried completely out of my depth. This, of course, pleased me immensely, as I felt that I was receiving value for money.

It is, however, chiefly with the exhibits that I wish to deal. Everything which I have demanded from the manufacturers in previous years was there. You know how often in the past I have pleaded that the dials and control knobs of all radio-gramophones should be placed on the front of the cabinet in a position easily accessible from the old armchair.

True, some manufacturers had already exploited the idea in certain of their models, but hitherto none of them had adopted my suggestion that, for æsthetic reasons, a sliding door should be fitted to cover over the controls when not in use. Judge of my delight, then, to see that the manufacturers this year have gone the whole hog and given us all this and more as well. The dial itself is clear, open and perfectly comprehensible to the meanest intelligence.

The "rejector and repeat" button of the record-changing device was arranged so as to be operated by a bell push on the other side of the room. As for the record changer itself, the larger manufacturers had obviously taken cognisance of my hint that the poverty-stricken public frequently ignores the more expensive twelve- and ten-inch records in favour of the humble eight-inch type. With a commendable unselfishness, foresight and more than a touch of the *noblesse oblige* business, the manufacturers have arranged, by a simple readjustment, to accommodate a pile of these proletarian eight-inchers. Even in the less advanced types of record changer there is the throw-off lever, so that the gramophone can be used as an ordinary hand machine if desired.

A Real Surprise

I have not recovered from the surprise (I am writing this in the flurry and confusion of the Underground Railway, so forgive split infinitives) at discovering the almost universal acceptance of my demand for the fitting up of sets to cover the 10-100 metre waveband as well as the conventional "medium" and "short." The job, I am glad to notice, has been done thoroughly, and all the necessary wave-changing or short waves is done by means of specially designed switches. No half-hearted attempts have been made to fob



Happiest part of a sorry story.

us with plug-in coils. One maker, in fact, had gone so far as to rope in the "ultra shorts" from 5 to 10 metres

Later. I was just about to place an order for a modestly priced radio-gramophone containing all the features I have already mentioned when I heard a soothing voice say: "Drink this and you will feel better."

By a miracle of some sort I was in a strange bed. Bending over me was a charming nurse. This was the happiest part of a sorry story. Apparently I had got the worst of an encounter with a van when I was attempting to cross the road on my way to Olympia. The first person to recognise the prone figure in the gutter was a prominent radio manufacturer, who promptly shook hands with the driver.

B.B.C. Loves a Joke

SOON after I had put the finishing touches to my newly constructed 5- to 7-metre receiver, the data for which I lifted wholesale out of "W.W." a few weeks



To get the customary denial.

back, I was astonished to get the London Regional at truly prodigious volume on the loud speaker.

Naturally, my first thought was that the B.B.C. ultra-short-wave transmitter was in operation at last, so with a joyful heart I rang up Broadcasting House, only to get the customary denial which every Government department makes at first, no matter what the accusation.

As soon as I returned to my receiver I realised, of course, that they were pulling my leg. It is no good talking to me about getting an harmonic of the ordinary Regional transmitter, for down on the waveband on which I was operating I could only have struck the umpteenth harmonic, whereas the signal strength I was getting would have made even the second harmonic look foolish.

However, the incident shows that the B.B.C. is still human enough to enjoy a good joke, and I expect they would be ready to try it again on anyone who asked whether they were transmitting last night on 1554.4 metres. "No," they would say.

Olympia's Story



THE technical staff of "The Wireless World" have spent their days at Olympia since the eve of the opening. Here, in the following pages, they present the reader with the result of their investigations. Every stand has been visited, and our staff photographers have been responsible for the illustrations which accompany the descriptions of the exhibits. Now the show moves on to Glasgow, where another exhibition opens its doors on September 1st in the Kelvin Hall.

ACTON BATTERY CO.

Sold under the trade name of Cynthex, the standard-capacity dry H.T. batteries manufactured by this firm are produced in all normal voltages, and are intended for a discharge rate of from 7 to 8 milliamps. Gold Seal and Eltax batteries are made in larger sizes, and give from 10 to 35 milliamps.

On this stand were shown Young accumulators, both for H.T. and L.T.; the latter include "mass" type and multiple-plate cells.

Acton Battery Co., Ltd., Dorland House, Regent Street, W.1.

ADEY.

A series of exceptionally small portable sets were exhibited by this firm. All

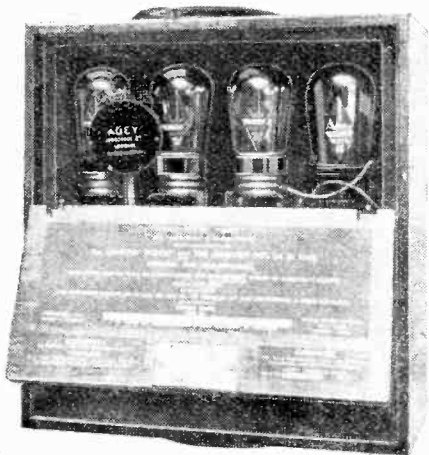

Adey compact portable receiver.

models are basically similar, but either Class "B" or pentode output stages are fitted. A feature of these sets is the Adey self-coupling valve, which includes an anode choke, wound in three sections round the base of the valve. This is available separately at the price of 6s. 6d.

Adey Portable Radio, 99, Mortimer Street, W.1.

AERIALITE.

As specialists in aerial equipment one naturally found on this stand a wide selection of aeriols of various types made up into convenient lengths.

Earth tubes and aerial fixing brackets were also features of the exhibit.

Aerialite, Ltd., 10, Amber Street, Manchester.

AERODYNE.

This firm were showing a wide range of straight sets, the smallest being the "Swift" three-valve battery set at 4 guineas; this is of the detector-L.F. type. The "Kestrel," a similar type of set but with a Class "B" output stage, is priced at £7 19s. 6d. The valves in the "Eagle" transportable are arranged as an H.F. stage, detector, L.F., and pentode output, and the price, including batteries, is 10 guineas. A five-valve superheterodyne, the "Falcon" is listed at 13 guineas, and this has a detector-oscillator frequency changer and a Class "B" output stage; a permanent magnet moving-coil speaker is included.

Hustler, Simpson, and Webb, Ltd., 317, Hoe Street, Walthamstow, E.17.

A
Stand-to-Stand
Review of the
New Season's
Products Com-
piled by the
Technical Staff
of "The Wire-
less World"

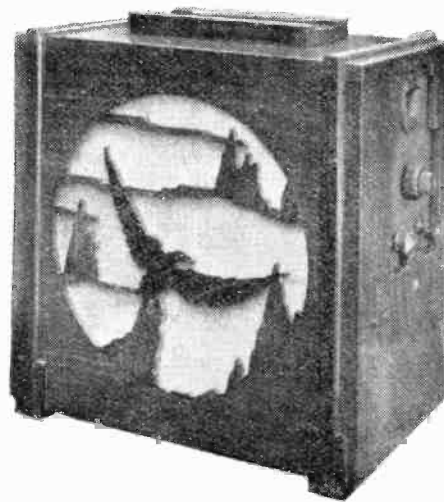

Aerodyne Eagle four-valve transportable.

ALBA.

One of the chief exhibits on this stand was the Alba Superhet 5, which is available for mains or battery operation. In the mains model the valves are arranged as a single-valve frequency changer, an I.F. stage, a screen grid second detector, and a pentode output valve, whereas the battery model has a Class "B" output valve, and a driver stage is included. The prices range from 13 guineas, according to the cabinet work. A number of straight sets was also being shown.

A. J. Balcombe, Ltd., 52, Tabernacle Street, E.C.2.

AMPLION.

Although specialising formerly in loud speakers only, Amplion's exhibits this year

Olympia's Story—

included a good range of Class "B" components, a Class "B" driver transformer in three ratios and a three-ratio tapped output choke. A binocular H.F. choke is also a new product.

The "Audiola" speaker is an addition to the P.M. range and is fitted with a universal transformer.

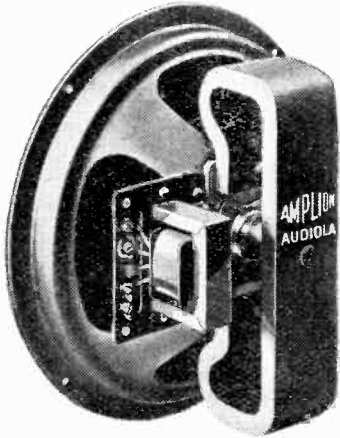

"Audiola" speaker fitted with universal transformer.

Midget speakers of attractive design under the name "Sonette" were of particular interest.

Amplion (1932), Ltd., 82-84, Rosoman Street, E.C.1.

APOLLO.

This firm is well known for gramophone playing desks, and an attractive selection of these, both as table and pedestal types, are produced in both mahogany and walnut and fitted with spring or electric Garrard motors.

Apollo Gramophone Co., Ltd., 4, Bunhill Row, E.C.1.

AUTOMATIC COIL WINDER.

In addition to the two well-known Avometers there was shown this year a new

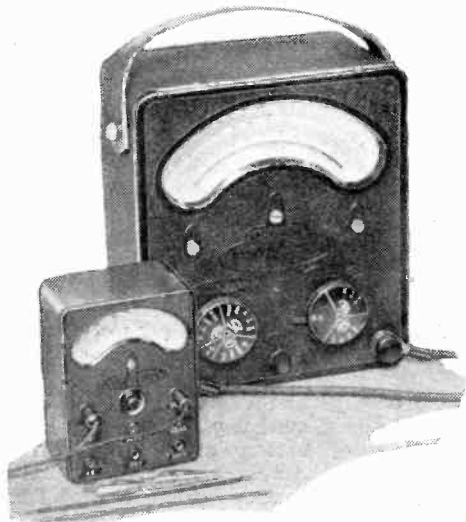

Universal Avometer and new Avominor.

junior model. Described as the Avominor, it has three voltage ranges, 0-6, 0-120 and 0-300, three current ranges, 0-6 mA, 0-30 mA, and 0-120 mA., and provision for resistance measurements up to 10,000 ohms. By the use of an external battery the resistance ranges can be extended to 0-60,000 ohms and 0-1.2 megohms. Measuring 4in. x 3in. x 1½in. and complete in case with leads the price is £2.

There was also an improved version of the Avodapter, that useful adjunct to the Avometers for testing voltages and currents of valves under working conditions. The price is the same, viz., 25s. for the adaptor and 7s. 6d. for the special plug.

Automatic Coil Winder and Electrical Equip. Co., Ltd., Winder House, Douglas Street, S.W.1.

B.S.R.

Amplifiers with outputs varying between 6 and 30 watts, most of which include S.G. valves in a special resistance-coupled circuit, are produced by this firm. A typical model, rated at 60 watts dissipation (15 watts A.C. output) embodies two stages of amplification followed by two of the new Mullard DO.26 valves. Full-wave rectification is carried out by two separate valves, and a multi-ratio output transformer is provided.

A self-contained radio chassis, with two H.F. stages, a triode power grid detector, and its own power supply equipment, is a new departure. The output of this apparatus, which amounts to between 1 and 2 volts, may be fed into any amplifier; indeed, it may be said that it "replaces a pick-up."



B.S.R. radio chassis for connecting to any L.F. amplifier.

The B.S.R. transformers, with special high-permeability nickel iron cores, have especially good characteristics in spite of their small size. It is stated that the output is constant within 2 or 3 per cent. between 30 and 10,000 cycles.

Birmingham Sound Reproducers, Ltd., Claremont Street, Old Hill, Staffs.

B.T.-H.

The exhibit of outstanding interest on the B.T.-H. stand was the 16 mm. Sound-and-

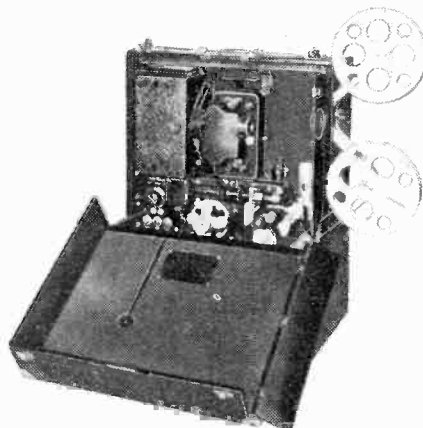

The projector unit of the B.T.-H. portable 16 mm. film and sound equipment.

Film Reproducer. The equipment consists of three units—all easily portable—the projector, loud speaker unit and the screen. The amplifier associated with the speaker gives 3-watts undistorted output and is, therefore, adequate for reproduction before small audiences. The speaker is the famous R.K. permanent magnet type. The equipment has many applications, especially in the field of education.

The various models of B.T.-H. electric gramophone motor comprised the principal other exhibit and the range included a universal D.C.-A.C. motor as well as the A.C. and D.C. types.

British Thomson-Houston Co., Ltd., Crown House, Aldwych, W.C.2.

BAIRD.

Both mirror-drum and cathode-ray televisors were on view on this stand. A special feature was being made of the Baird grid cell unit which is used in the former receiver and which is available separately at the price of £2. It is of the Kerr cell type, and requires a polarising potential of about 425 volts and a maximum modulating potential of 125 volts.

Baird Television, Ltd., 133, Long Acre, W.C.2.

BAKER.

This firm has an enviable reputation for the production of moving-coil loud speakers of the highest quality, and several examples of the "Super Power" type were shown.

In the more popular class the "Permag" unit was shown in redesigned form, and special prominence was given to the new class "B" converter which, although designed primarily for use with the Baker, may be used with equal success, from the electrical standpoint, with other units. It is housed in a cast aluminium screening box which is the correct height to fit under the "Permag" field magnet, and comprises a 1:1 driver transformer with a 300 ohm secondary, seven-pin valve holder and an output choke or transformer. A special

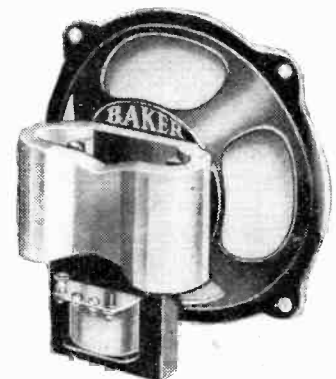

The new "Permag" speaker by Baker's Selhurst Radio.

plug adaptor is provided to interpose between the driver valve and its valve holder in the existing set. The price of the unit alone (without valve) is 37s. 6d., or incorporating the "Permag" loud speaker unit, 75s.

Baker's Selhurst Radio, 75-77, Sussex Road, Croydon, Surrey.

BECOL.

Ebonite in all its forms was exhibited by this firm of specialists, which produces panels, coil formers, mouldings, and extruded strips in a wide diversity of sections. The coil formers range from the smallest size, suitable for short-wave H.F. chokes,

Olympia's Story—

to those employed in winding the largest high-efficiency coils.

The productions of Postlethwaite Bros. were exhibited on this stand; whistle suppressors, screened choke, and an entirely new iron-cored H.F. choke were included.

British Ebonite Co., Ltd., Nightingale Road, Hanwell, W.7.

BEETHOVEN.

Portable or self-contained sets figure largely on the programme of this firm. The new Major model includes a fairly conventional det.-L.F. circuit, but employs iron-cored tuning coils and a moving-coil loud speaker; it is of the suitcase type.

Another recent set is the transportable with a similar circuit and also embodying a high-efficiency pentode output valve.

Montague Radio Inventions and Development Co., Ltd., Beethoven Works, Great College Street, Camden Town, N.W.1.

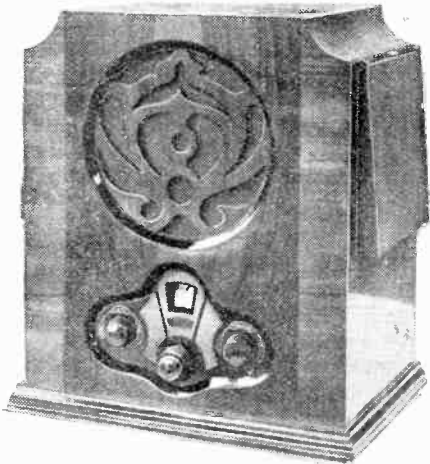

Beethoven transportable receiver.

BELLING-LEE.

Among the new items introduced this year is a range of three gramophone pick-ups. One model has been designed for easy attachment to a portable gramophone and is described as the Clip-on Unit model; of the others one incorporates a volume control. These cost 35s. each and without volume control 27s. 6d. A mains interference eliminator priced at 9s. 6d. will be found especially useful.

The other new items include a twin mains input connector embodying two fuses, and a three-pin plug and socket which is particularly suitable for connecting the loud speaker to a Class "B" valve. In addition, there is a very extensive range of indicating terminals, plugs and sockets, fuses and sundry other small but exceedingly useful parts.

Belling and Lee, Ltd., Cambridge Arterial Road, Enfield, Middlesex.

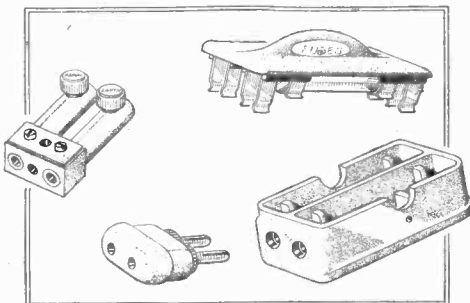

Belling-Lee twin chassis-mounting terminal and new fused mains plug.

BENJAMIN.

This year's series of Magnavox speakers show every evidence of maintaining the high reputation they have attained.

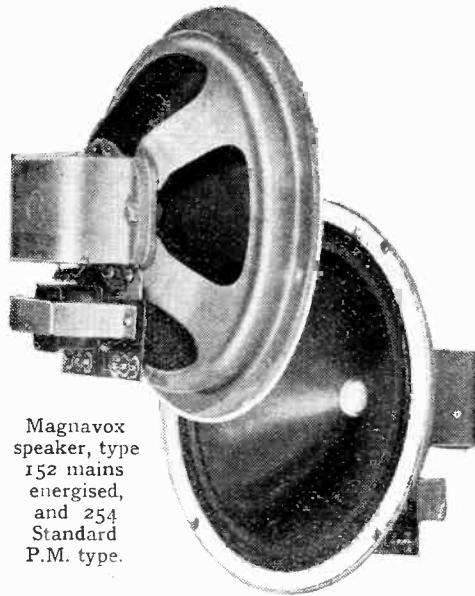

Magnavox speaker, type 152 mains energised, and 254 Standard P.M. type.

Mains energised and P.M. speakers are available in different models and a speciality is made of dual-compensated speakers, both in energised and permanent magnet types. The Magnavox-Senior P.M. is a new model. A point worthy of note is the care with which printed instructions for transformer connections have been prepared.

Benjamin products of special interest shown were Class "B" driver transformers, Class "B" universal chokes, and some new valve holders, including seven-pin types.

Benjamin Electric, Ltd., Brantwood Works, Tariff Road, N.17.

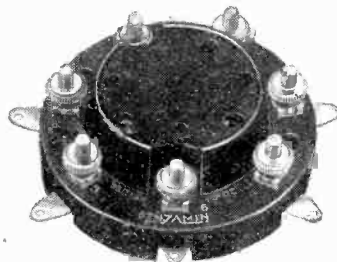

The new Benjamin valve holder for seven-pin valves.

BLOCK BATTERIES.

The exhibits on this stand consisted of a range of H.T. and L.T. batteries of the lead-acid type but distinguished by the fact that the customary lead-grid plate is not used. The saving in weight and space conferred by this method of construction is considerable, for a 60-volt 5,000 m.A. hour unit is assembled in a case measuring 14 1/2 in. x 4 1/2 in. x 5 1/2 in. high and the weight is 16lbs. The price is 37s. 6d. A 2-volt plate-less L.T. cell of 80 amp. hours capacity weighs but 6 1/2 lbs. and costs 11s. 6d.

Block Batteries, Ltd., Abbey Road, Barking, Essex.

BLUE SPOT.

Visitors to this stand had an opportunity of listening to the new 45 P.M. and 29 P.M. loud speakers which have been introduced since the last show to supplement the 99 P.M. All three models were shown in chassis as well as cabinet form, and a feature was made of the introduction of

"extension" models—without transformer—for connection to receivers with low impedance output circuits.

An important recent addition to the moving-coil list is the 29/DC—an energised model supplied with 120-, 2,500- or 7,500-ohms field and costing 27s. 6d.

As regards sets, the company is concentrating on a 4-valve battery receiver with band-pass tuning, a Class "B" output stage and a moving-coil loud speaker. This set as a table model will cost £9 19s. 6d., and as a pedestal model £12 19s. 6d.

The latest Blue Spot Model 33 pick-up is a handsome looking component and has a performance curve of excellent general form. Another component shown for the first time was the 66 R.B. moving-iron loud speaker unit in which the windings have been specially arranged for Class "B" output valves.

British Blue Spot Co., Ltd., 94-96, Rosoman Street, E.C.1.

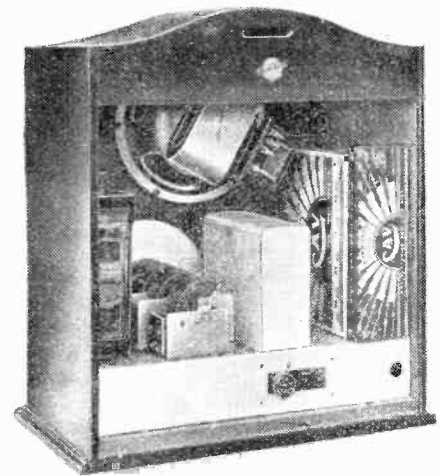

An interior view of the new Blue Spot Class "B" battery set.

BOTOLPH RADIO.

The Emperor Superhet IV occupied a prominent position on this stand. This is a four-valve set at 15 guineas, which includes automatic volume control, and a battery model is available. A Universal III model for use on either D.C. or A.C. mains without alteration was also shown.

Botolph Radio, Ltd., 119, Bishopsgate, E.C.2.



Block H.T. and L.T. batteries

BOWYER-LOWE & A.E.D.

The principal business of this firm is the manufacture of high-grade gramophone pick-ups and allied apparatus. Their latest model, the "Mark IV" pick-up, has been designed for de luxe radio-gramophones where the highest quality of reproduction is required and special attention has been

Olympia's Story—

paid to finish in order that it will blend well with expensive cabinet work. Two alternative models are available, the one giving exact compensation for reduction of bass in recording and the other with a more pronounced rise in the bass to meet special requirements. The price of this new model is 42s. The "Mark III" and "Beta" pick-ups are being continued. In addition to the standard range of wire-wound volume control resistances a new combined volume and tone control unit is being shown. This unit is self-contained in a walnut bakelite moulding and has independent controls for volume and tone, the latter being designed to give a variable top cut-off down to 1,000 cycles. The price of this unit is 10s.

Bowyer-Lowe and A.E.D., Ltd., Diamond Works, Coombe Road, Brighton.

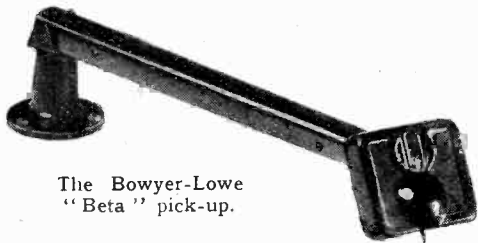

The Bowyer-Lowe "Beta" pick-up.

BRITISH GENERAL.

Of the many components shown on this stand the principal item of interest was the All-wave Tuner covering 14.5 to 2,000 metres and priced at 9s. 6d. It is a continuous coil with the various sections so disposed that the idle ones, which are short-circuited, introduce negligible damping. Two switches are employed, one for wave change and the other for selecting the aerial tapping most suitable for the local conditions. Flexible couplings and extension

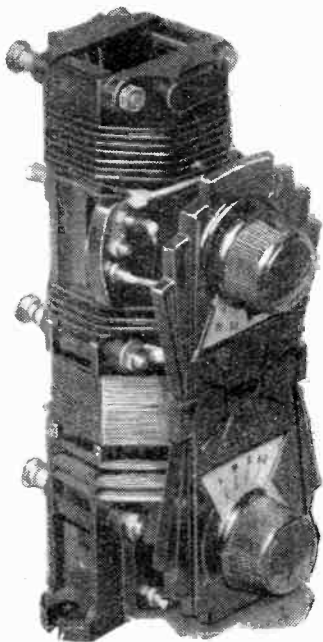

British General new All-wave Tuner.

rods were shown also, thereby enabling the unit to be mounted away from the panel to avoid hand capacity effects.

Among other new components were a screened H.F. choke and a parallel feed transformer unit at 10s.

British General Mfg. Co., Ltd., Brockley Works, Brockley, S.E.4.

BRITISH RADIOPHONE.

A wide variety of components was shown on this stand, and the well-known Radio-

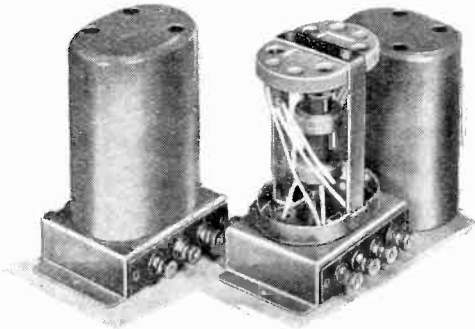

British Radiophone I.F. transformers.

paks have been extended to include super-heterodyne types and a two-H.F. straight model. The coils employed in these are also available as separate units. I.F. transformers with external trimming adjustments are now supplied at the price of 10s. Gang condensers of the straight and super-heterodyne types were on view, in addition to a number of tuning dials; one of the latter deserving special mention is the dual-ratio model, with which ratios of 10-1 and 60-1 can be readily obtained.

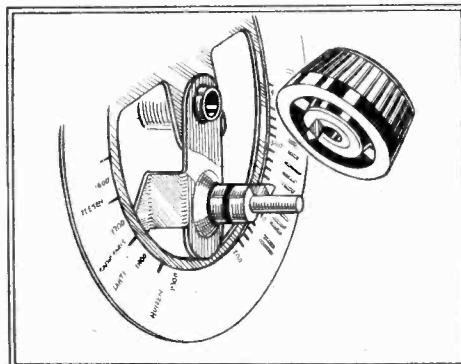

British Radiophone dual-ratio dial.

Class "B" transformers, Q.M.B. switches, and fixed condensers formed an important part of the exhibit, while anti-static screened lead-in cable was on view; this is priced at 10s. per 15ft. The Radiophone pick-up now appears in new form, with a volume-control potentiometer neatly built into the base.

British Radiophone, Ltd., Aldwych House, Aldwych, W.C.2.

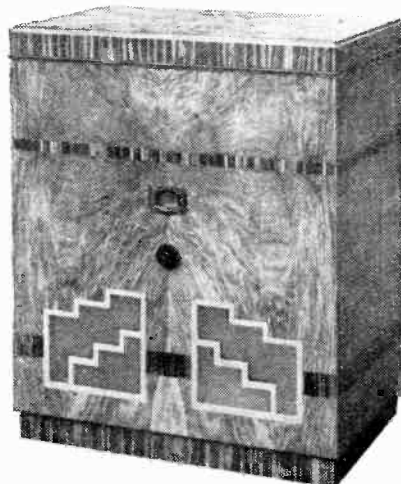

Brunswick 8-valve radiogram with dual speakers and amplified A.V.C.

BRUNSWICK.

An interesting range of superheterodynes was exhibited by this firm, comprising five, six and eight valve models. The eight valve model is specially attractive, for it includes dual loud speakers, automatic volume control, and tone control.

The tuning device renders the speakers inoperative until the desired station is tuned in, and tuning is obtained by a visual method. The automatic tone control compensates for the reduction of bass which occurs normally at low volume. Station names, as well as wavelengths, appear in projected illumination on the escutcheon.

Brunswick, Ltd., 1-3, Brixton Road, S.W.9.

BULGIN.

Not only has an immense number of new components been introduced this year, but many of last season's models have been modified and improved.

The Thermal Delay Switch is now adjustable for time lag; the Transcoupler, as shown in the type "B" and priced at 12s. 6d., has a 1:4 ratio transformer and incorporates 3-watt resistances; the range of D.C. mains resistances is extended to include models suitable for the 20-volt 0.18 amp. values, while the L.F. transformers and H.F. chokes are now housed in neat bakelite cases.

So far as the new items are concerned, mention can be made here of a few only, but attention is drawn to the range of Class "B" components of which the output choke is especially interesting, since it provides seven ratios and the price is but 12s. 6d. The 3-watt volume controls ranging from 5,000 ohms to 25,000 ohms is new, and the price is 3s. 9d. in all values. There

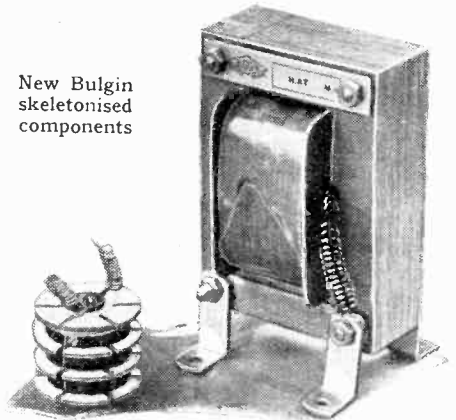

New Bulgin skeletonised components

is a series of interference suppressor units for motors at prices of from 3s. to 12s. each.

Another innovation is a range of manufacturers' type, or "stripped," components consisting of 4-, 5- and 7-pin valve holders, five types of L.F. chokes ranging in price from 8s. 6d. to 13s. 6d., and H.F. chokes at 1s. 6d. There is a range of multiple contact Q.M.B. switches with rotary action and having four alternative "on" and "off" positions. In a three-pole pattern the price is 6s. 6d. Switches have been given considerable attention this year and the extent of the Bulgin range may be gauged by mentioning that there were about 40 types.

A. F. Bulgin and Co., Ltd., Abbey Road, Barking, Essex.

BULLPHONE RADIO.

A series of eliminators for both A.C. and D.C., together with a number of components, represent the main activities of

Olympia's Story—

this firm. There was also shown a novel type of loud speaker, embodying two entirely separate coil-driven cones mounted at each end of a cylinder about one foot long, a baffle being fitted at one end.

Bullphone Radio, New North Road, Barkingside, Essex.

BURGOYNE.

This exhibit comprised series of inexpensive battery-operated sets, sold complete with all accessories at prices varying between £3 17s. 6d. and 9 guineas. All are chassis-built, components being clamped on to the base-plate in a particularly ingenious manner without the use of screws.

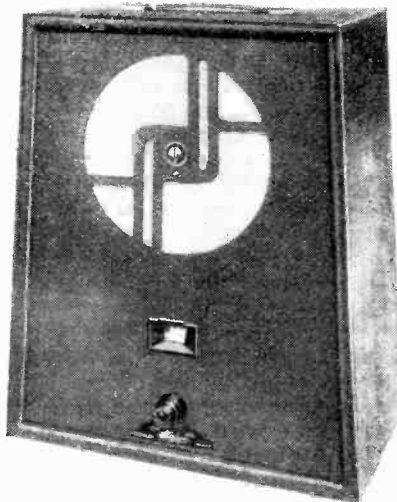

Burgoyne popular receiver.

Several models are fitted with a frame, and so are completely self-contained.

Burgoyne Wireless (1930), Ltd., 34a, York Road, King's Cross, N.1.

BURRELL RADIO.

In addition to the three-valve straight set recently reviewed in *The Wireless World*, two up-to-date A.C. superheterodynes have recently been produced. The first, with four valves plus a valve rectifier, includes band-pass input, a pentode frequency changer, one I.F. stage, and a double-diode-triode second detector which provides delayed A.V.C. The output valve of this set, which costs 13 guineas, is a four-watt pentode; an exceptionally large output is a feature of all Burrell sets.

The five-valve superhet is similar; it has the same number of tuned circuits, but instead of employing a band-pass input, an H.F. stage is added, with single-tuned aerial-grid and intervalve couplings. With dual loud speakers and mounted in an ex-

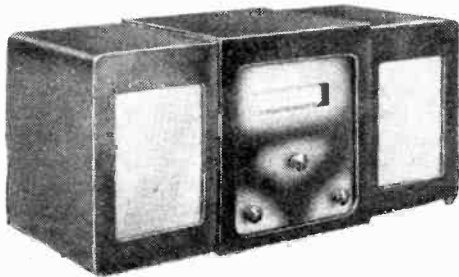

Burrell superheterodyne with twin speakers.

tremely modern style of cabinet, this set costs only 17 guineas.

Burrell Radio, Ltd., 45, High Road, Willesden Green, N.W.10.

BURTON.

The new four-valve S.G. Class "B" receiver incorporates one variable-mu H.F.

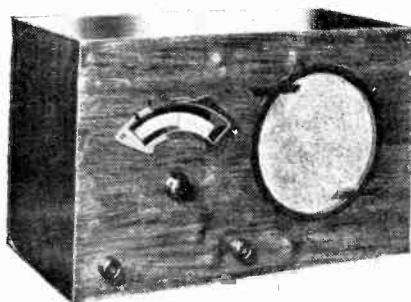

Burton S.G.4 Class "B" receiver, de luxe model.

stage, a leaky grid detector followed by a driver stage and a Class "B" output valve. A P.M. moving-coil loud speaker is fitted and the maximum power output is about two watts, yet the average total anode current is no more than 11 mA. The cabinet is of modern design, with the speaker and receiver mounted side by side and the price is £8 10s., or in a de luxe cabinet £9 2s. 6d.

The new range includes, also, a three-valve Class "B" set at £6 15s. giving one watt output, a three-valve S.G. receiver at £6 10s. and an S.G.-det.-Pen. A.C. mains receiver costing £8 19s.

To the range of components has been added a Class "B" driver transformer with two alternative ratios and a Class "B" unit for converting existing battery sets. The price of this is 35s.

C. F. and H. Burton, Progress Works, Bernard Street, Walsall.

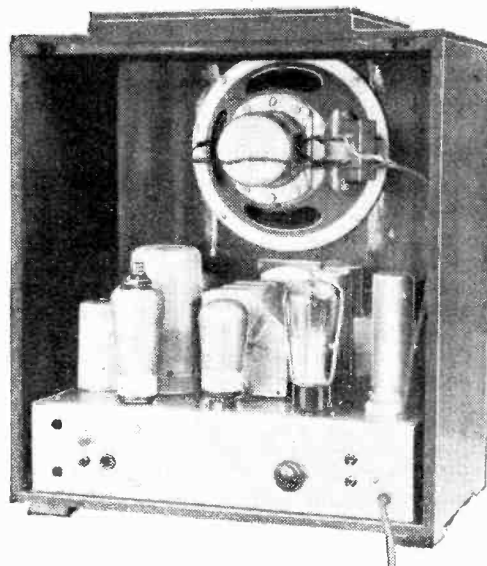

Bush Radio SAC6 superheterodyne.

BUSH RADIO.

The mirror-drum televisior was one of the principal features of this exhibit; it includes a television receiver, and the output stage employs two 25-watt valves, one for feeding the Kerr cell and the other for the synchronising mechanism.

A number of straight sets were shown in addition to superheterodynes. Of the latter the model SAC6 is of the four-valve type, with a detector-oscillator and a pentode output valve. A Westector is used for A.V.C. purposes, and the set is priced at 16 guineas.

Bush Radio, Ltd., Woodger Road, Shepherd's Bush, W.12.

C.A.C.

A wide range of receivers and cabinets was shown on this stand. The Cambridge A.C. Three model is interesting in that a single-tuned aerial circuit with an iron-core coil is used to precede the H.F. pentode power-grid detector, which is resistance-transformer coupled to the output pentode. The price is £9 15s. The "Oxford" Ferrocart Class "B" Four is similar to *The Wireless World* Ferrocart Class "B" re-

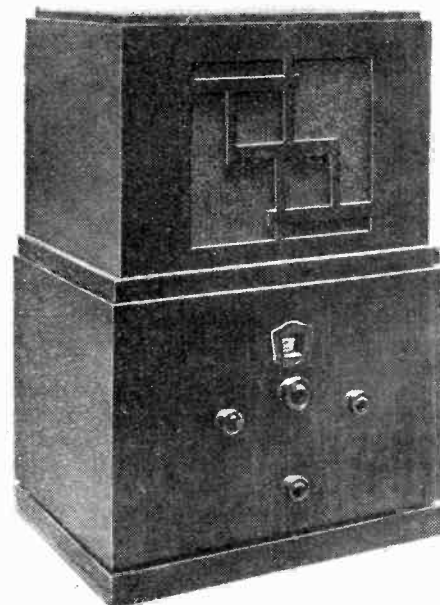

City Accumulator Company's Cambridge Ferrocart A.C.3.

ceiver, and is priced at 10 guineas. A new superheterodyne, the C.A.C. Pentagrid Superhet, was shown, and this includes a pentagrid frequency changer and a duo-diode-pentode second detector giving A.V.C.

Kits of parts for *The Wireless World* New Monodial Super were on view, and a special cabinet for this set is priced at £5 10s. A stamped metal chassis was also shown.

City Accumulator Co., Ltd., 18-20, Norman's Buildings, Central Street, E.C.1.

C.A.V.

Much progress has lately been made in the design of small H.T. generators, whereby the output from an L.T. battery—or even of a low-voltage house-lighting plant—may be "stepped-up" for anode supply. In addition to the well-known M.L. converters and rotary transformers shown by this firm, there is an innovation in the form of a machine of which the regulation is so good that it may be used for feeding a Class "B" output stage.

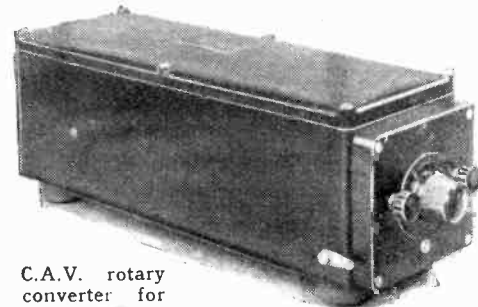

C.A.V. rotary converter for Class "B."

The most up-to-date generator of all is a model for supplying H.T. to car radio sets; it is enclosed in a weatherproof inverted case, primarily intended for mounting below

Olympia's Story—

the floorboards, and gives an output of 220 volts at 40 mA. Both 6-volt and 12-volt models are made. Many other generators,

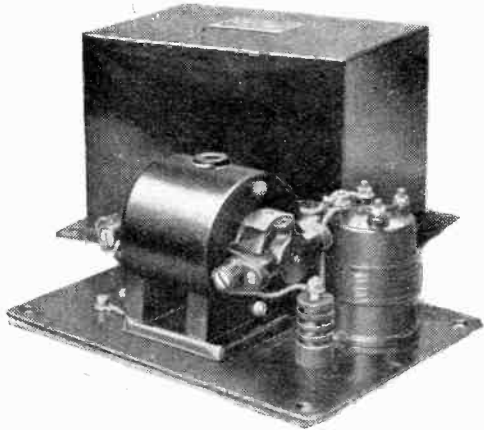

C.A.V. H.T. generator for car sets.

both of the A.C.-to-D.C. and D.C.-to-A.C. types, are available for meeting special requirements.

Among other exhibits was a synchronous gramophone motor, which represents an improvement over last year's model, but is also reduced in price. There are also mains transformers for "A" and "B" class rectifying valves, and for Westinghouse rectifiers, types H.T.9, 10 and 11.

The range of C.A.V. dry-cell and accumulator batteries is exceptionally complete, and in addition there are several new L.T. coils, including one of unusually compact, low-built design.

C. A. Vandervell, Ltd., 319, Regent Street, W.1.

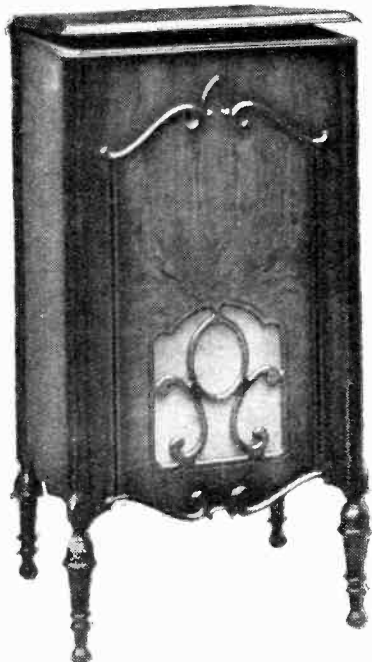

For the new "Wireless World" Monodial: the Camco Gresham cabinet.

CAMCO.

Many of the older style cabinets are to be discontinued as soon as present stocks are exhausted, and of those retained for the coming season interest will centre largely on the Gresham model at £6 and the Popular at 75s., as both of these are suitable in size for housing the new *Wireless World* Monodial.

A very modern design in which the set and loud speaker are mounted side by side is

the new Daventry model which measures 11in. x 22in. x 10in. deep inside. Finished in walnut, the price is 36s., which includes a baseboard 22in. x 10in.

Carrington Mfg. Co., Ltd., 24, Hatton Garden, E.C.1.

CELESTION.

Having good reason to be well satisfied with the basic design of their existing speakers, Celestion have wisely continued their models in three ranges with little alteration except in some important matters of detail.

The S.29 "Reetone" dual speaker was exhibited. This model is supplied with two transformers, one to match the speaker input and the other to enable high-note response to be adjusted. This is done by the simple process of changing over plugs from one socket to another.

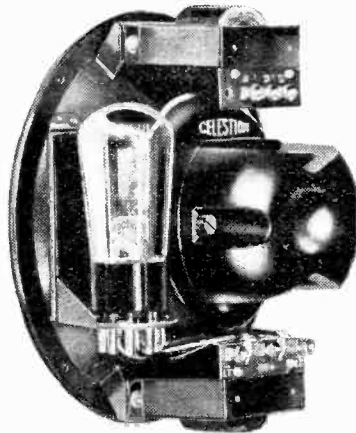

The Celestion P.M.9 Class "B" speaker chassis, complete with output stage.

A P.M. speaker, the P.M.9, with Class "B" output stage combined, is an attractive unit, and this can be supplied complete with cabinet.

The Celestion pick-up was another interesting component.

Celestion, Ltd., London Road, Kingston-on-Thames.

CHORLMET RADIO ELECTRIC.

A midget moving-coil loud speaker with a bakelite chassis, measuring only 6½in. in overall diameter, was exhibited by this firm, which has also produced a Class "B" output unit for adding to existing sets. This appliance is completely self-contained, with a loud speaker and a valve holder for the additional valve. A similar device, but without a loud speaker, is mounted on a neat moulded bakelite base. Other ex-

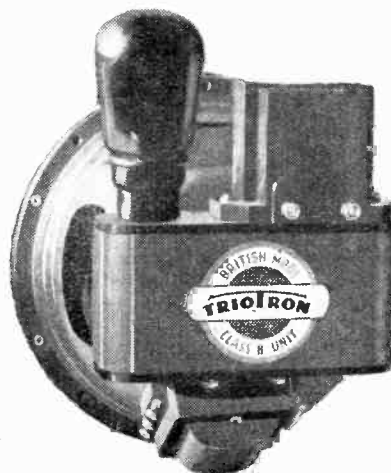

Chorlmet Class "B" unit.

hibits were Stal Class "B" and Q.P.P. components, and a range of standard screened tuning coils sold at 4s. 6d. each.

Chorlmet Radio Electric, Ltd., Stal House, Judd Street, W.C.1.

CLARKE'S ATLAS.

The range of Atlas receivers introduced last year is now considerably extended, and battery as well as A.C. sets are included. An interesting model is the Atlas A4, available in either cabinet or console form. It embodies a three-valve circuit, and is distinguished by the use of pentode valves in all positions with the exception of the rectifier. It incorporates a moving-coil loud speaker, and the price of the Console model is £13 17s. 6d.

Another interesting model is the B4, a battery-operated cabinet receiver embodying one H.F. stage, detector, driver, and Class "B" output valve. The H.T. consumption is approximately 8 mA. at 120 volts, and the price is £11 17s. 6d. An Atlas P.M. moving-coil loud speaker is fitted. A useful feature of all the Atlas receivers is the provision of a removable station-calibrated scale. Should changes take place in the allocation of wavelengths new scales could be supplied and easily fitted by the listener.

Atlas eliminators have been improved, and the range extended to include models for use with Q.P.P. and Class "B" receivers. They range in price from £2 19s. 6d. for the C.A.25 A.C. model to £6 10s. for the A.C.300; the last mentioned provides H.T. grid bias, and includes an L.T. trickle charger.

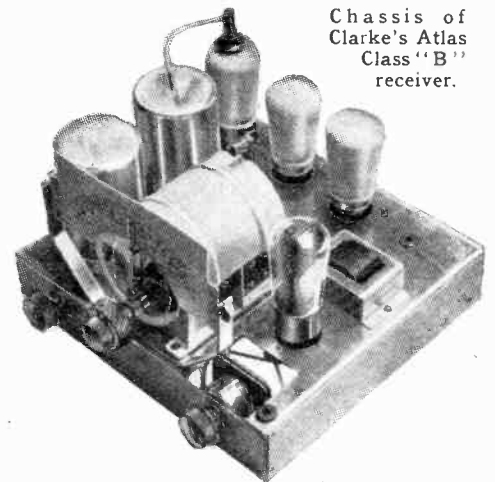

Chassis of Clarke's Atlas Class "B" receiver.

Finally, there is the Atlas range of energised and permanent-magnet moving-coil loud speakers.

H. Clarke and Co. (M/c), Ltd., George Street, Patricroft, Manchester.

CLIMAX.

The latest Climax receiver, the Casket Superheterodyne, is mounted in a most unusual form of cabinet, which does not in any way suggest a radio set. The base is slightly raised on feet; the loud speaker is mounted on the floor in a horizontal plane and so is completely out of sight. This A.C. set, which costs 16 guineas, embodies a four-valve superheterodyne circuit with band-pass input and a special second-channel interference eliminator. The same chassis is embodied in the S.4 model, which is of more conventional appearance externally.

The Climax "straight" three-valve receiver, which has an extremely high reputation for selectivity, is now mounted in a

Olympia's Story—

modern horizontal cabinet and is sold at the reduced price of 12 guineas. An up-to-date battery receiver, with a permanent-

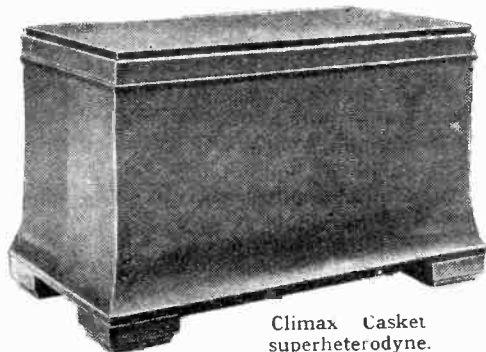

Climax Casket superheterodyne.

magnet moving-coil loud speaker and pentode output, is also produced.

Climax Radio Electric, Ltd., Haverstock Works, Parkhill Road, N.W.3.



Clix "air-sprung" anti-microphonic valve holder.

CLIX.

The new "Airsprung" anti-microphonic valve holders of the chassis mounting type formed the chief exhibit on this stand. In the 5-pin type with terminals the component is priced at 1s. 3d. A 7-pin "Floating" model is priced at 1s. A wide range of terminals and connectors was also shown.

Lectro Linx, Ltd., 79a, Rochester Row, S.W.1.

COLUMBIA.

There were few stands at Olympia where such a wide range of efficient sets could be seen as on that of Columbia, and prices varied from £5 to 90 guineas. At the latter price the star set of the stand was the "Autoradiograph de Luxe Ten," Model 640.

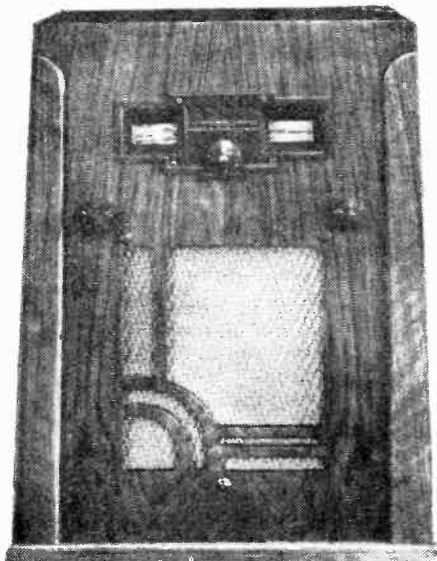

The Columbia CQA Battery Four.

This is a console superhet. for A.C. mains, with delayed automatic volume control. Tuning is by wavelengths and stations by name. The gramophone equipment incorporates a record changer having a magazine capacity of eight records.

A more popularly priced superhet. is the Model 631, of seven valves, which also incorporates a record changer.

In straight sets, a four-valve radiogram at 23 guineas is particularly attractive.

What promises to be one of the most popular Columbia models this season is the CQA Battery Radiograph, Model 1003. Here is a set where quality of reproduction, both on radio and gramophone records, has been put before all other considerations, and this in spite of the fact that it is a battery set. The circuit of this receiver is three H.F. band-pass stages with variable-mu valve, transformer coupled to the detector, and push-pull pentode output stage. On the score of quality of reproduction it is stated that, tested on full output, the harmonic content was less than 5 per cent. The undistorted output is 1½ watts. The gramophone motor is a double-spring type, and the pick-up the standard Columbia model.

Another Columbia model at a low price is the 11-guinea CQA Battery Four, Type 1001.

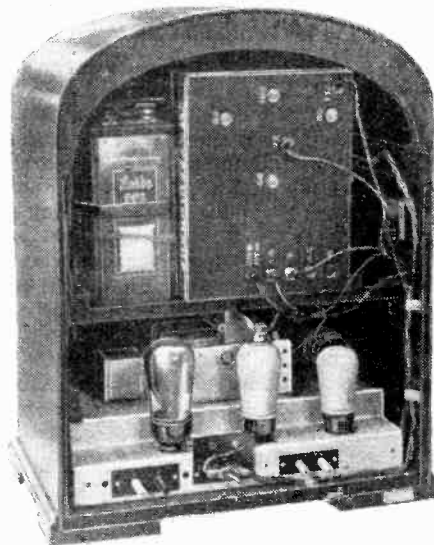

Internal view of the Columbia Battery Three, Model 1005.

Tuning is by stations as well as wavelengths, and provision is made for a gramophone pick-up to be connected.

Columbia Graphophone Co., Ltd., 98, Clerkenwell Road, E.C.1.

COLVERN.

The new Ferrocort coils in one form or another constituted the principal interest of the Colvern exhibit this year. The range is very extensive indeed, for there were on view the latest miniature series, also an I.F. transformer. Although the miniature type offers all the advantages of the earlier design they occupy far less space; for example, a three-coil assembly, including switch mechanism ganged with a spare toggle switch, is mounted on a panel only 6½ in. long. The price is 12s. 6d. per coil.

The I.F. transformer fitted with the new style core and described as the type FC110 embodies a variable capacity coupling, since for obvious reasons the variable mutual inductance coupling is not practicable with this style. They cost 12s. 6d. each, and the primary is tapped for the anode connection.

Two coil-and-condenser assemblies described as Colpak Tuning Units were shown.

Type H has the coils and condenser mounted side by side, and costs 57s. 6d. for a triple assembly. In the other style, type V, the

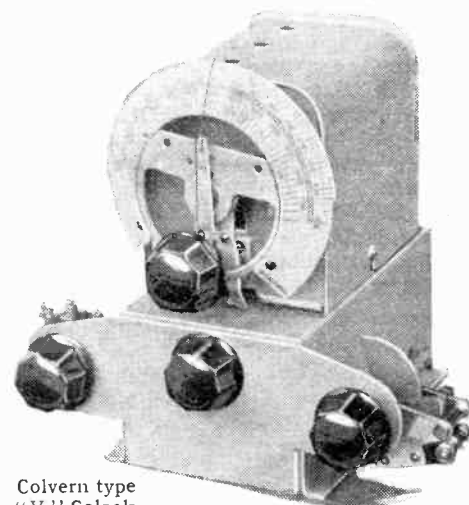

Colvern type "V" Colpak.

coils are mounted below the chassis, and the price is 62s. 6d., also for the triple model. This includes, in addition, a reaction condenser and a volume control, and, of course, Ferrocort coils are fitted.

A full range of air-cored screened coils were on view.

Colvern, Ltd., Mawneys Road, Romford, Essex.

CONSOLIDATED RADIO CO.

The exhibits of this firm comprised a wide range of battery sets in portable, transportable, and cabinet form, also two mains sets. Of the battery models the most interesting is the Rolls Caydon Transportable Four, for it incorporates such modern features as full-vision wavelength scale, H.F. amplification and Class "B" output, and the price is 10 guineas. In a de luxe cabinet it costs 12 guineas.

Consolidated Radio Co., Ltd., Warple Way, Acton, W.3.

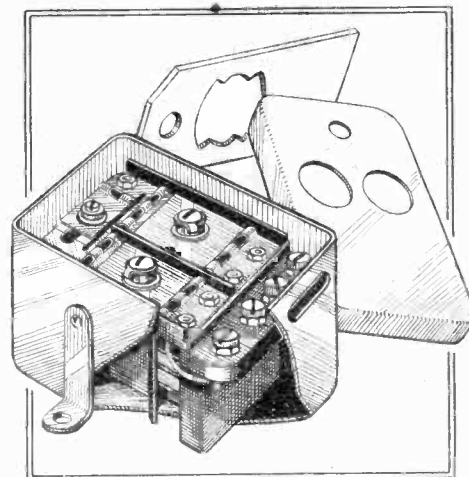

New Colvern I.F. transformer with Ferrocort core.

CORONET.

In addition to showing a selected range of manufacturers' products, this firm were featuring a range of sets of their own make. Known as the Coronet series, it includes a three-valve battery set at £4 10s. and a Class "B" three-valve model at £6 15s. A similar set embodying an H.F. stage was priced at £8 8s. Also, there were five- and seven-valve mains superhets at 13 and 16 guineas.

Faudels, Ltd., 36-40, Newgate Street, E.C.1.

Olympia's Story—

COSMOCORD.

A comprehensive range of gramophone pick-ups of moderate price was displayed on this stand, the most interesting being the Super Model at 22s. 6d. The moulded bakelite tone arm is fitted with an adjustable counterbalance weight, and a shunt-type volume control resistance is incorporated in the base.

A smooth and noiseless wire-wound potentiometer at 3s. 6d., or with switch 5s. 6d., was another well-made product of this firm.

Cosmocord, Ltd., Cambridge Arterial Road, Enfield, Middlesex.

The Cosmocord Super model pick-up.

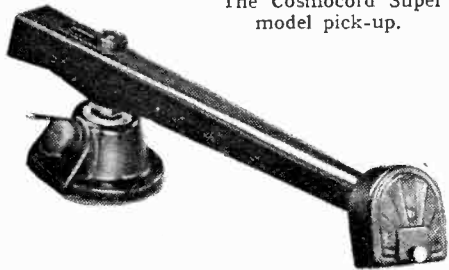

COSSOR.

All the new valves, including the latest multi-electrode types, were exhibited by Cossor, and little purpose would be served by giving a mere catalogue of recent innovations. It should be noted, however, that two different Class "B" valves are available; the original high-output type, 240.B,

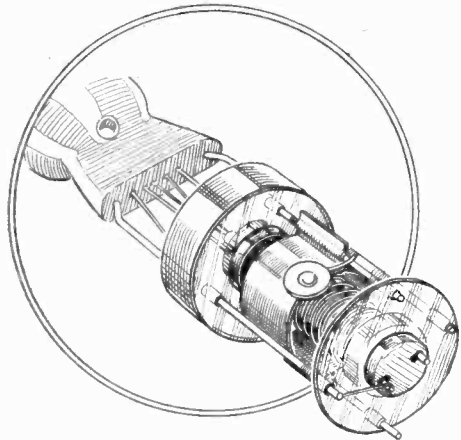

Electrode assembly of Cossor MVS/PEN.

consumes 0.4 amp. filament current, while the newer type, 220.B, gives about half the output and consumes 0.2 amp. Another interesting valve is the MVS/PEN, an indirectly heated H.F. pentode handling a large input and in which the suppressor grid is connected externally to a separate pin instead of being joined internally to the cathode. This gives scope for many circuit innovations; for instance, the A.C. resistance of the valve may be artificially reduced by the judicious application of a polarising voltage. A complete range of D.C. valves, consuming 0.25 amp., is now produced.

The new Melody Maker kit set is already well known. A basic straight H.F.-det.-L.F. circuit is included in all models, but in the battery versions the purchaser has the choice of pentode or Class "B" output and of a moving-iron or moving-coil loud speaker. In the A.C. mains model of the same set an energised moving-coil loud speaker is fitted.

A number of completed receivers were shown, including a very interesting battery-fed superheterodyne with the unusual

feature of a pentode driver preceding the Class "B" output stage; a pentode also serves as a combined detector-oscillator.

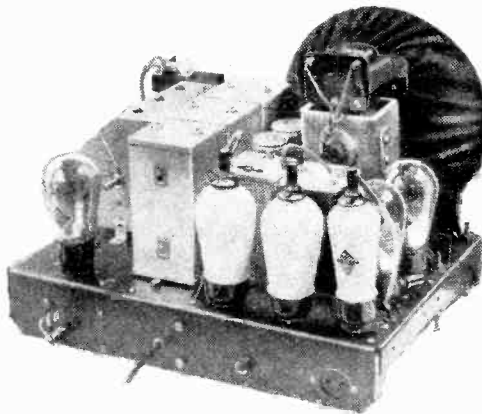

Chassis of Cossor battery superheterodyne.

There is also an A.C. superheterodyne planned on similar lines, but with a separate oscillator, which feeds into the suppressor grid circuit of the MVS/PEN second detector.

A. C. Cossor, Ltd., Cossor House, High-bury Grove, N.5.

CROMWELL.

The S.H.8.B. was the chief receiver on this stand, and it is an eight-valve battery superheterodyne. There are H.F. and I.F. stages, a two-valve frequency changer, a diode second detector, driver and Class "B" output; A.V.C. is included. It is claimed that the total anode current consumption is 6 to 10 mA., and the set is priced at 18 guineas including batteries. A similar A.C. model at the same price has a $3\frac{1}{2}$ watts output stage and is fitted with Q.A.V.C.

A number of interesting straight sets was shown, and a universal A.C./D.C. receiver of the three-valve type at 12 guineas was exhibited. This set is suitable for 200/250 volts supplies of either A.C. or D.C.

Cromwell (Southampton), Ltd., 32-33, Brinton's Terrace, Southampton.

CRYPTO.

As battery charging equipment is the speciality of this firm, the exhibits here

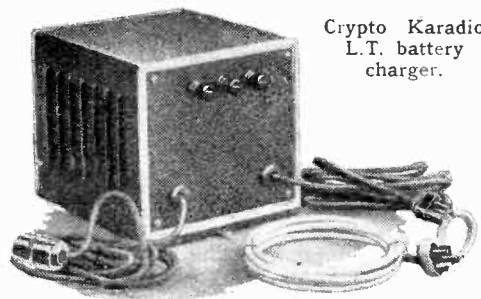

Crypto Karadio L.T. battery charger.

were of interest mainly to the service station engineer, for there is a wide range of valve rectifier types of from 1.3 to 15 amps. output, also constant potential rotary models for heavy duty purposes.

A home model, styled the Karadio charger, was shown for the first time. It has been designed for charging car and wireless batteries, and automatically adjusts itself for 2-, 4-, 6-, and 12-volt batteries, and the price is £4.

Lancashire Dynamo and Crypto, Ltd., 94, Petty France, Westminster, S.W.1.

DAGENITE.

A series of accumulators of all types and all capacities and including special batteries for H.T. purposes were shown by this firm. A special cell, enclosed in an opaque moulded case and intended primarily for battery hire services, has just been introduced; in this cell a special sealing system is employed for making the joint between the pillar and lead. An acid-proof connection is obtained by the use of a rubber gasket and a vaseline cup.

Peto and Radford, 107a, Pimlico Road, S.W.1.

DARWINS.

Although of interest primarily to manufacturers of loud speakers, pick-ups, moving-coil microphones, etc., the comprehensive

Darwins permanent magnets of one-piece castings.

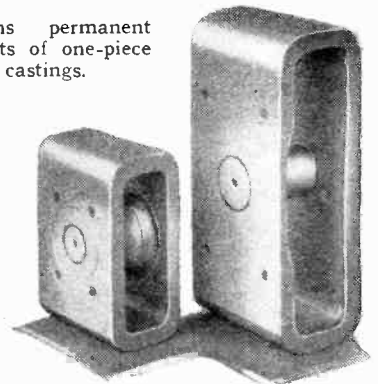

range of permanent magnets of up-to-date design proved in itself an education to visitors of a technical turn of mind.

Darwins, Ltd., Fitzwilliam Works, Sheffield.

DAVENSET.

Prominent on this stand was the range of Davenset M.G.C. battery chargers fitted with valve rectifiers and embodying a mechanical overload cut-out. There are four models in the series, and the M.G.C.5 will handle both H.T. and L.T. accumulators and has five independent circuits. The prices range from 14 to 31 guineas.

A full range of mains transformers and chokes was shown, and while the same high standard is maintained, prices are now considerably lower, the reduction being as much as 20 per cent. in many cases. There was also a selection of Grippleshell aerial fittings.

Partridge, Wilson and Co., Davenset Works, Evington Valley Road, Leicester.

DAVIS MFG. CO.

The leading Davis exhibit was a five-valve superheterodyne (the Victory Model) arranged as a radio-gramophone. It includes band-pass input, a screen grid first detector, a separate oscillator, a variable-mu I.F. amplifier working at 110 kilocycles,

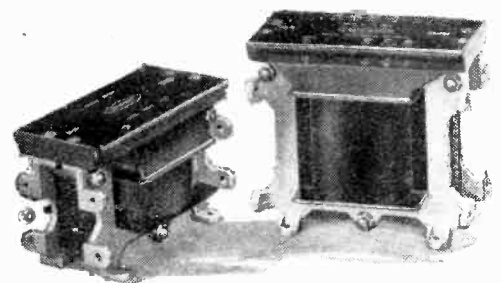

Davenset 30-H. 50-mA. choke and step-up mains auto-transformer.

Olympia's Story—

and a power grid detector, transformer-coupled to a pentode output valve.

The Davis Universal A.C.-D.C. set embodies an H.F.-det.-L.F. circuit, with a current-limiting barretter and 20-volt 0.18-amp. valves.

Davis Mfg. Co. (Finsbury), Ltd., 18, Christopher Street, E.C.2.

DIGGLE.

This firm has for long specialised in the manufacture of the "Reliance" charging plant of the motor-generator type. The apparatus is very robust, slow running and automatic in action. There are models for charging H.T. batteries with four circuits at £33; H.T. and L.T. batteries with eight circuits—four L.T. and four H.T.—at £60, also several large multi-circuit models.

Alfred Diggle and Co., Jane Street, Rochdale, Lancs.

DRUMMER.

This firm were showing a wide range of up-to-date battery and mains-operated receivers and radio-gramophones. Heading the list of standard models is a six-valve, including rectifier, superhet. radio-gram, fitted with an automatic record changer, and

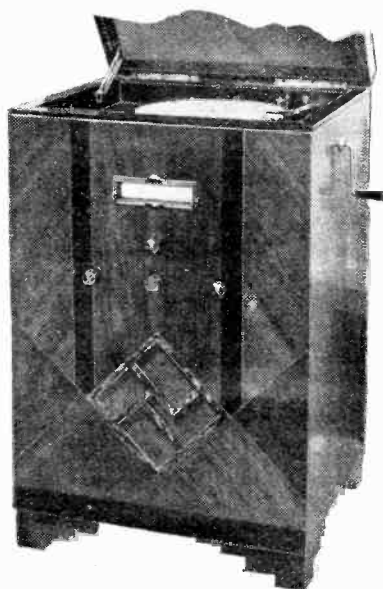

Drummer Radio battery radio-gramophone, incorporating Class "B" output.

described as the model R.M.S.6a. It incorporates delayed A.V.C., dual loud speakers, and has seven tuned circuits. The combined frequency changer valve is preceded by one H.F. stage and followed by one I.F. amplifier fitted with a variable- μ H.F. pentode. Follows a double-diode-triode as second detector and A.V.C. control valve, and a pentode valve delivering three watts to the dual speakers. It is fitted with an automatic record changer and the price is 42 guineas, or, as a cabinet set, 19 guineas.

At the other end of the range is a four-valve battery set, the B.4, priced at 14 guineas. Here, again, an up-to-date specification is found, for band-pass tuning, Class "B" and a P.M. moving-coil loud speaker are embodied. The quiescent current is between 8 and 10 mA, and the power output 1½ watts. As a radio-gramophone with a double-spring motor, the price is 21 guineas.

Edge Radio, Ltd., Bolton, Lancs.

DUBILIER.

The Dubilier exhibit this year was remarkable for the diversity of the new types

of condensers shown. Non-inductive condensers are now housed in a new-style cylindrical metal case which screws into a special baseboard fitting, so making changes or replacements, should the occasion arise, a very simple matter. Known as the Type 9200, an old type number by the way, they now include also the BS, LSB, LSA, LEC,

Group of Dubilier condensers, showing tubular, new electrolytic, and non-inductive models.

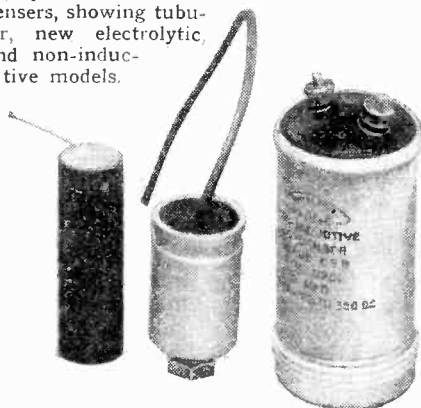

LEG, LBG and LSG series. A 2-mfd. 9200 type of 250 volts working is now priced at 3s. 6d., while a 350-volt model of the same capacity, LEG 9200, cost 6s.

The dry electrolytic range is now very extensive; one new model which will undoubtedly be extremely popular is the type 401 at 2s. 6d., two examples being 10 mfd. at 50 volts working and 20 mfd. at 25 volts. These are suitable for grid circuit decoupling. There was a range of tubular dry electrolytics with wire ends, and, in all, some twenty-seven miscellaneous dry electrolytics are now available.

Finally, there were the Dubilier motor car suppressor resistances, for use with car radio, a set of four being priced at 10s. 6d.

Dubilier Condenser Co. (1925), Ltd., Ducon Works, Victoria Road, North Acton, W.3.

EARL.

Moving-coil speakers were shown on this stand, the feature of particular interest being a speaker having a special volume control included. The volume control is stated



Earl P.M. speaker fitted with volume control for local operation.

to act as a potentiometer of low impedance across the secondary of the speech transformer, to give a steady variation in volume without affecting the audio frequency response. The unit is particularly suitable

for use as an extension speaker, with local control.

Earl Mfg. Co., Ltd., Avenue Works, Hanover Park, S.E.15.

EDDYSTONE.

Among many new short-wave components which have been recently introduced by this firm of short-wave specialists is a multi-range switched coil unit. Five wave-ranges are covered by switching, each unit being entirely separate and comprising primary, secondary, and reaction windings; the switching system is cleverly devised and should be trouble-free. Different types are available, and the purchaser can exercise choice as to the wave-ranges provided.

Some of the new H.F. components are constructed of Frequentite, a new porcelain-like material which is particularly suitable for short-wave work, as its losses are exceptionally low; in addition it should stand up well to tropical conditions.

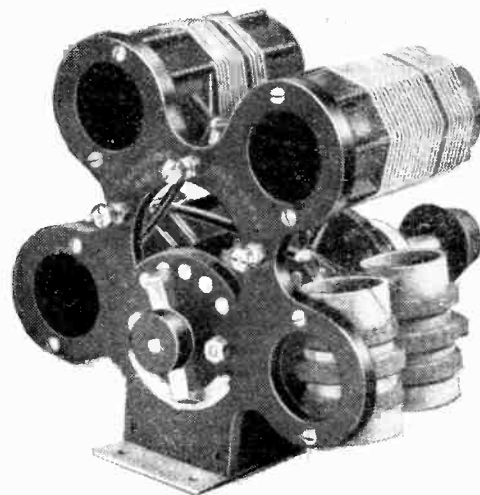

Eddystone 5-range tuning coil.

The new wide-vision tuning dial embodies a 25:1 reduction gear constructed with an exceptionally high degree of accuracy, and seems to be a very practical device for its special purpose.

One of the most interesting of the new Eddystone sets is the six-valve superheterodyne, A.C. operated and covering the short- and medium-wave ranges only. A modern horizontal cabinet contains an energised speaker.

Stralton and Co., Ltd., Balmoral Works, Bromsgrove Street, Birmingham.

EDISWAN.

Among the wide range of Mazda valves shown, the AC.2/Pen. was particularly interesting in view of its high mutual conductance of 8 mA/V. and its output of nearly 3½ watts. A battery type duo-diode-triode, the L.2/DD, was worthy of special attention. The range of D.C. valves and H.T. rectifiers remains largely unaltered, but the A.C. range has been extended by the addition of duo-diode types and an H.F. pentode. The AC.2/Pen. is listed in a duo-diode type. A cathode ray tube was being demonstrated, and the television model is listed at 6 guineas.

The well-known B.T.-H. pick-ups were on view, and the Senior model is priced at 37s. 6d. complete with volume control; the output is about 1 volt, and the impedance at 4,500 cycles is 40,000 ohms. The range of R.K. speakers has been extended, and in addition to the Senior models, Major and Minor types were also shown. The Senior

Olympia's Story—

model is available in A.C., D.C., and permanent magnet types, the D.C. model being priced at 5 guineas.

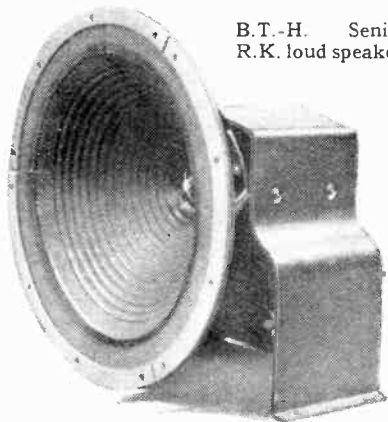

B.T.-H. Senior
R.K. loud speaker.

The Major R.K. speaker is of the D.C. type and has an 8in. cone; in chassis form it is priced at £2 17s. 6d. complete with multi-ratio output transformer. The Minor speaker is a permanent magnet type and is available in cabinet form at the price of £2 17s. 6d. complete with transformer.

A wide range of output transformers of different ratios and current ratings for R.K. speakers, head telephones, and H.T. batteries and accumulators completed the principal exhibits.

Edison Swan Electric Co., Ltd., 155, Charing Cross Road, W.C.2.

EELEX.

Apart from the manufacturers' products which constitute the wholesale section of this firm's activities, the most interesting exhibit was a modulated oscillator for set testing. The instrument consists of a single valve H.F. oscillator modulated by gramophone records, and the wave ranges covered are from 200 to 600 metres and 1,000 to 2,000 metres respectively. Complete in oak cabinet, with spring motor and pick-up, the price is £6 15s. Provision is made for housing the batteries in the cabinet.

In addition, there was the range of Eelex short-wave converters and the recently introduced Duplex coil and coil chassis, the price of the latter being 25s.

J. J. Eastick and Sons, 118, Bunhill Row, E.C.1.

EKCO.

The principal exhibit on this stand was undoubtedly the new Model 74 superheterodyne. This is of the five-valve type with band-pass input to the detector-oscillator, a single I.F. stage, and a duo-diode-triode second detector giving delayed A.V.C. A pentode output valve is fitted, and a valve rectifier. A special point is made of the detachable speaker grille for easy replacement of the silk backing, and the tuning indicator takes the form of a wedge of light instead of the usual pointer. In a black and chromium cabinet, this model is priced at 14 guineas. Models are also available for D.C. mains and for battery operation, and the latter is fitted with Class "B" output.

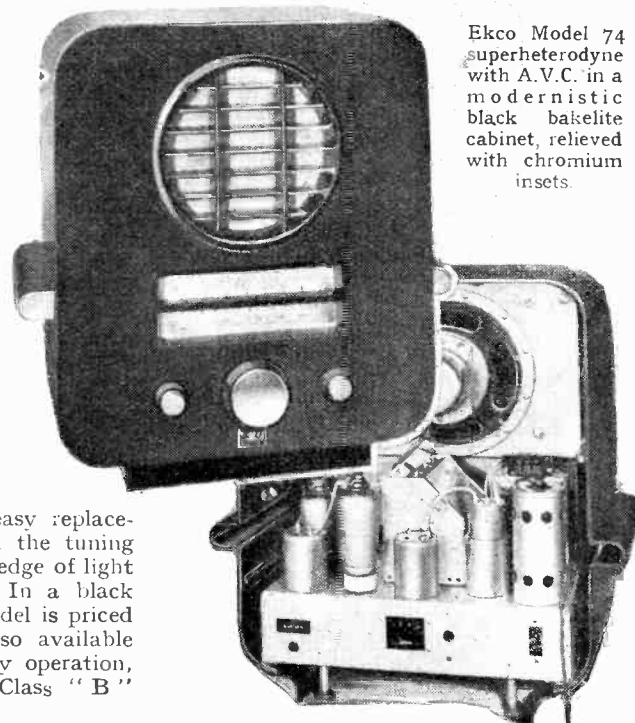

Ekco Model 74
superheterodyne
with A.V.C. in a
modernistic
black bakelite
cabinet, relieved
with chromium
insets.

The S.H.25 superheterodyne was also being shown, at the price of 15 guineas, and this model employs a two-valve frequency changer. A three-valve straight set in both console and radio-gramophone form was on view, and also a range of H.T. eliminators.

A car radio receiver of unusual type was exhibited. Instead of being arranged for remote control, the whole superheterodyne chassis is designed for mounting behind the instrument board. The loud speaker, of course, is a separate unit.

E. K. Cole, Ltd., Ekco Works, Southend-on-Sea, Essex.

ELDECO.

In view of the imminent sweeping changes in station wavelengths, one hardly envies the task of those who are responsible for preparing indicator dials for the new sets. In their new "Stenode" superheterodyne the

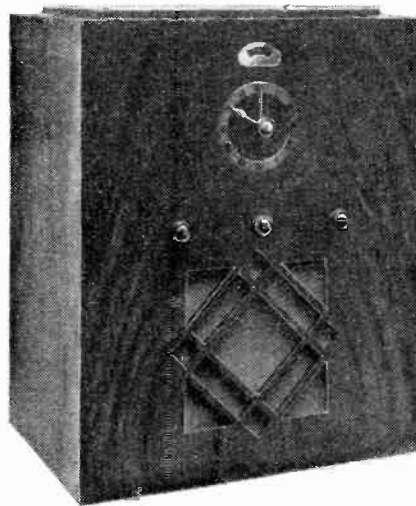

Eldeco Stenode superheterodyne with
"clock" dial.

Eldeco concern have provided an ingenious solution by devising a clock-dial tuning system, which facilitates the logging of stations. Each minute represents one-quarter of a degree of condenser rotation,

and so settings may be recorded very accurately in a manner that is easy to memorise. The set includes six valves, one of which is a tone-corrector.

The Eldeco six-valve portable superheterodynes seem to be the only ones of their type in suitcase form; one of these models is fitted with the clock-dial system of tuning.

Eldeco Radio, Ltd., 62, Conduit Street, W.1.

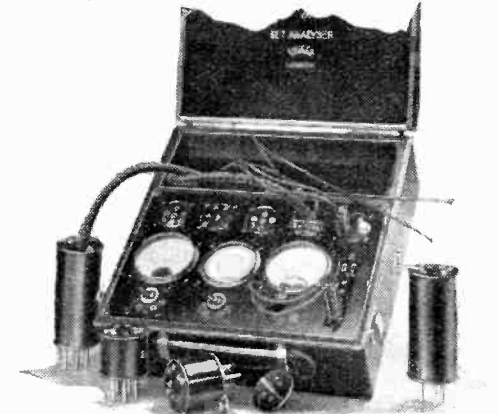

The Emicol Set Analyser, a product of
Electrical Measuring Instrument Co.

ELECTRICAL MEASURING INSTRUMENT CO.

This firm were showing a wide range of inexpensive measuring instruments of the single and multi-range type, also a very useful test set described as the "Emicol" Set Analyser at 7 guineas. It includes three separate meters, a two-range universal A.C. and D.C. voltmeter, a two-range milliammeter and a three-range moving-coil voltmeter with a resistance of 1,000 ohms per volt. Provision is made for testing four-, five-, and seven-pin type valves.

Electrical Measuring Instrument Co., Ltd., 55, Cardington Street, N.W.1.

ELECTRO-DYNAMIC.

As specialists in the design of rotary converters this firm were showing a range of machines for obtaining A.C. from D.C.

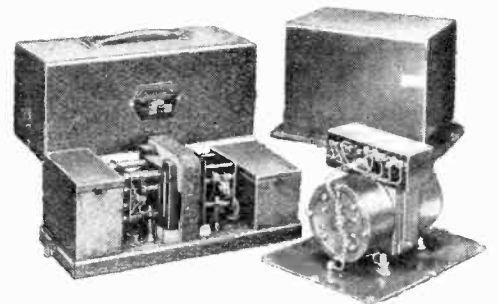

Electro-Dynamic L.T.-to-H.T. converter and
new car radio H.T. generator.

supply mains, from country house lighting sets and from batteries. Also models for voltage raising using a D.C. input. Of particular interest was the new Car Radio Converter. This operates from the starter battery and gives a smoothed D.C. output of 200 volts at 40 mA. Complete in waterproof metal container for letting into the floorboards, the price is £6 4s.

Electro-Dynamic Construction Co., Ltd., Devonshire Grove, S.E.15.

ELECTRON.

The activities of this firm are devoted mainly to the production of aerial and earth equipment for indoor and outdoor use. A

Olympia's Story —

number of very useful accessories in this category were included in their exhibit.

New London Electron Works, Ltd., East Ham, E.6.

EPOCH.

In addition to the well-known "Super-cinema," "Domino," "99," and "20th Century" ranges of moving-coil loud speakers, a number of interesting new lines have been introduced for the coming season. Of these not the least attractive is the new "Super P.M." loud speaker at the very reasonable price of £2 5s. This is fitted with an 11 in. diaphragm and has a bass response which goes down to 35 cycles. It will handle 8 watts and is fitted with a 10-ratio output transformer. The new Type "A2½" model is a robust engineering job, and is enclosed in a cast aluminium body, the front of the diaphragm being protected by a cast aluminium grille. The output transformer is totally enclosed and as in the case of the "Super P.M." is provided with 10 ratios. The price of this model is

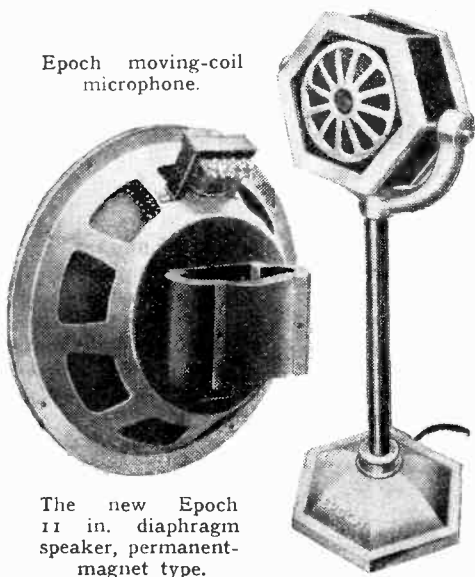

Epoch moving-coil microphone.

The new Epoch 11 in. diaphragm speaker, permanent-magnet type.

£3 3s. For portable loud speakers and car radio sets a new miniature unit, known as the "Super Dwarf P.M.," has been produced, complete with 5-ratio transformer, at 23s. 6d. It is fitted with a 5 in. diaphragm and is designed to handle 2 watts. For those wishing to modernise their receivers by the addition of Class "B" amplification, a special adaptor has been designed for use in conjunction with the "Popular" types of Epoch loud speakers. Finally, there is the Epoch moving-coil microphone, which has been especially developed for public address work.

Epoch Radio Mfg. Co., Ltd., Exmouth House, Exmouth Street, E.C.1.

EVER READY.

As might be expected, H.T. batteries for every conceivable wireless purpose formed the chief exhibit on this stand, the types ranging from the small "Winner" series for a 6 mA. discharge to extra-heavy capacity models for a drain of 30-40 mA. Grid bias and torch batteries were also shown, as well as numerous L.T. accumulators.

Ever Ready Co. (G.B.), Ltd., Hercules Place, Holloway, N.7.

EXIDE AND DRYDEX.

Exide L.T. accumulators were classified

under four main headings this year. Series "C," the standard popular type in glass and celluloid boxes for normal discharge; mass-type cells in category "D," De Luxe type HZ for heavy discharge, and unspillable cells.

The Drydex Green Triangle range is extended, three new models being included; a 99-volt+9-volt for grid bias at 10s.; a 123-volt+9-volt at 12s. 6d., also a 126-volt battery at 11s. For Q.P.P. and Class "B" use there are Yellow Triangle models.

The Brown Triangle models are for heavy-duty work, giving from 15 to 30 mA.

Chloride Electrical Storage Co., Ltd., Clifton Junction, near Manchester.

FERRANTI.

A display of components embracing almost every phase of wireless activity was to be found on this stand. Transformers of the ordinary, push-pull, Class "B," output, and mains types still form a large portion of this firm's products, but resistances, condensers, chokes, interference filters, eliminators, meters, loud speakers, valves, receivers, and kit sets occupied the greater part of the stand. The range of A.C. mains valves includes a duo-diode-triode and a Heptode, while there is a 2½ watts output triode valve of the directly heated type. Among the battery valves a Class "B" type was prominent.

The receivers included a five-valve model, the Lancastria, with a Heptode frequency changer, a duo-diode-triode second detector and a 2½ watts output stage. This set is priced at 15 guineas and a similar model with delayed A.V.C. and a visual tuning indicator was shown at 18 guineas. A five-valve battery superheterodyne with a Class "B" output stage and a frame aerial was priced at 17 guineas including batteries. The Gloria superheterodyne was also shown; this is a larger type with delayed A.V.C., a two-valve frequency changer, and a signal frequency H.F. stage; it is equipped with visual tuning.

Among the kit sets, the short wave receiver is deserving of special mention; it is a battery model with Class "B" output and

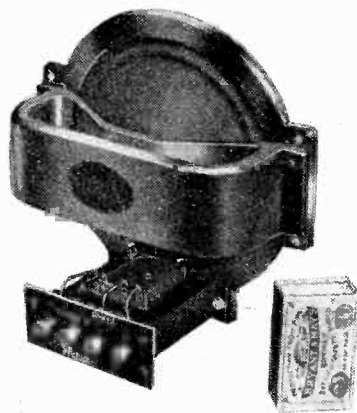

Ferranti M.6T speaker with universal transformer.

a screen-grid H.F. stage. Plug-in coils are used to cover the range of 15/600 metres.

The range of meters has been extended by the addition of a valve tester; the meter included is arranged for external use as a multi-range voltmeter and milliammeter. A multi-range A.C. test set was also shown.

The well-known M.1 loud speaker occupied a prominent position, but several new models were on view. The M.6T is of very modest dimensions, having a cone of only 4 in. diameter, and is priced at 31s. 6d. with universal transformer. A

larger model, the M.5, has a 6 in. cone and is priced at 30s. without transformer.

Ferranti, Ltd., Hollinwood, Lancashire.

FILM INDUSTRIES.

A new application of the latest battery set technique was to be seen in the F.I. "Baby" public address equipment, which comprises a Class "B" output stage, preceded by a driver and an L.F. amplifying valve. This equipment is battery driven, and so is entirely self-contained; it is intended for outdoor meetings, etc., and is stated to have an acoustic range of 500 yards.

Of course, Film Industries are best known for their moving-coil loud speaker units, mainly intended for fitting to loud speakers

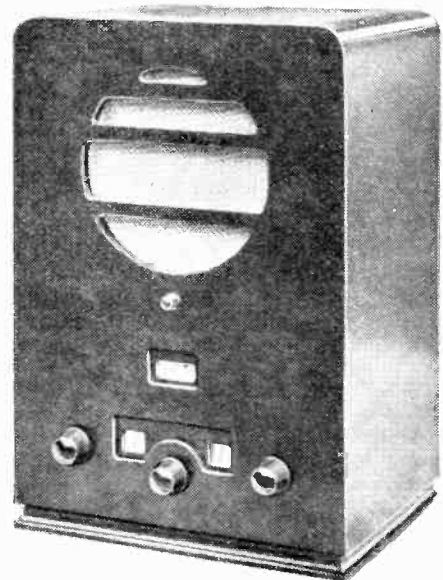

Ferranti Arcadia superheterodyne with Heptode frequency changer.

of the horn type. These units, together with horns of the "folded" and straight type, were exhibited, together with moving-coil microphones and various types of amplifying equipment.

Film Industries, Ltd., 60, Puddington Street, W.1.

FULLER.

To the range of L.T. "Mammoth" accumulators in glass containers has now been added a new model, the MDG, with a 45-amp.-hour capacity. This bridges the gap between the SDGH of 25 amp.-hours and the LDGH at 60 amp.-hours rating. It is fitted with non-interchangeable terminals, large moulded filler vent, a moulded lid with polarity signs and the "Mammoth" type plates. Gravity floats are included, and the price is 8s.

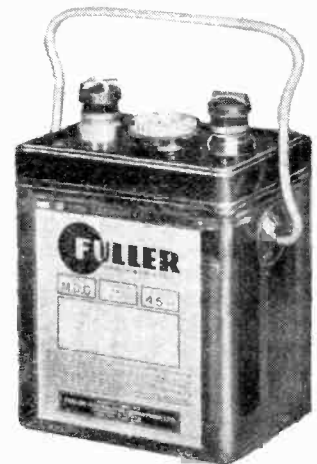

Fuller new M.D.G. 45 ampere-hour slow-discharge cell, complete with carrying handle.

Olympia's Story—

A long range of "Standard" cells in glass boxes, many unspillable models, 10-volt H.T. accumulator units, four different types of dry cell batteries, and grid bias batteries completed a very interesting exhibit.

Fuller Accumulator Co. (1926), Ltd., Woodland Works, Chadwell Heath, Essex.

G.E.C.

One of the novel features of this firm's exhibit was the car radio receiver which is supplied in three units—a moving-coil speaker fitted with a tone control, the receiver proper which comprises a five-valve superheterodyne with A.V.C., and the remote control unit to be mounted on the steering

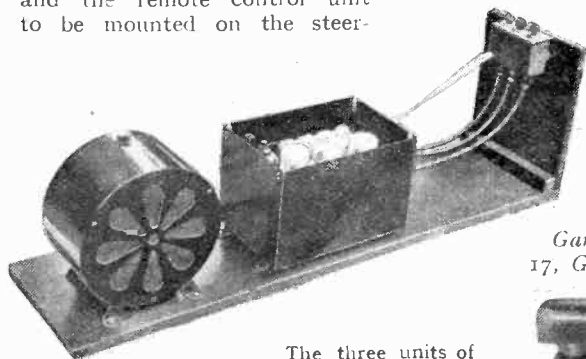

The three units of the G.E.C. car radio apparatus.

pillar of the car. Tuning, wave-range, and volume can all be adjusted from the control unit. Among the ordinary receivers, the Superhet 8 merited special attention if only on account of the delayed quiet A.V.C. system which is incorporated. The Superhet 5 is arranged with a band-pass input circuit to the detector-oscillator, a single I.F. stage, and a screen grid second detector resistance-coupled to the pentode output valve. The table model is priced at 14 guineas, but it is also obtainable as a D.C. set and in radio-gramophone form. A six-valve battery superheterodyne with a Class "B" output stage was on view, and a three-valve battery set of the det.-L.F. type was priced at £5 17s. 6d.

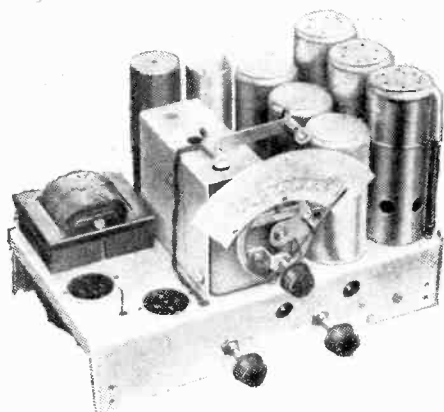

Chassis of the G.E.C. Superhet 5 for A.C. mains.

A wide range of G.E.C. H.T. batteries was shown and a particular feature is made of their capacity in milliwatt-hours being guaranteed. A number of Magnet accumulators was also on view. A new permanent magnet moving-coil speaker was shown, the small model being priced at 37s. 6d. and the large at 57s. 6d. including the containing cabinet.

The well-known Catkin valve was prominent among the valves exhibited, and in

the ordinary types a duo-diode-triode was to be found among both the A.C. and the D.C. ranges. H.F. pentodes were shown in mains and battery types, and the new 16 watts dissipation pentode is of special interest. The B.21 Class "B" valve was particularly interesting in view of its unusually low resistance, which is claimed to confer freedom from parasitic oscillation. The valve is designed to work with an appreciable negative grid bias, and will give an output up to 2 watts.

General Electric Co., Ltd., Magnet House, Kingsway, W.C.2.

GARRARD.

Garrard exhibited a wide range of gramophone motors, both spring and electric types. The automatic record changer at £10, which is a very fine example of accurate and substantial workmanship, was given a special display. This firm now produces a pick-up with volume control incorporated.

Garrard Engineering and Mfg. Co., Ltd., 17, Grafton Street, W.1.



The Garrard pick-up.

GODWINEX.

Exhibits on this stand consisted mainly of "Godwinex" eliminators in a variety of models and for all supplies, including one

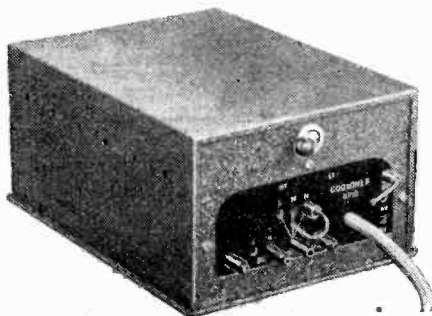

An example of Godwinex eliminators.

type specially smoothed for use when the supply is from mercury arc rectification.

Transformers specially designed for use



A new circuit tester of general application by Pullin.

with Westinghouse metal rectifiers formed the other feature of the stand.

Another item of interest on this stand was a universal tester by Pullin, of West Ealing.

J. Dyson and Co., Ltd., 5, Godwin Street, Bradford.

GOODMANS.

A model "P" speaker with a new system of cone mounting provided this firm's most up-to-date exhibit. A neat and small speaker of 8½ in. overall diameter, though

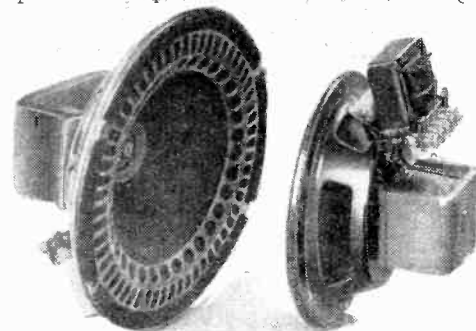

Two Goodmans speakers, Model P, with a new system of cone mounting, and another of energised type.

similar in other respects to the standard model, was seen in company with a still smaller model for midget radio sets measuring only 6½ in. in diameter, whilst still smaller models were also seen here.

Goodmans, 69, John Street, E.C.1.

GRAFTON RADIO.

Particularly interesting was the complete television outfit shown by this firm. Separate receivers are fitted for sound and vision, the former using an up-to-date three-valve circuit feeding a moving-coil loud speaker, while for the latter one with two variable-mu H.F. stages is utilised.

The television gear is of the projector type throwing a picture 9½ in. x 4½ in. on to a ground screen.

Of the other sets shown, a Class "B" five-valve set at 15 guineas well exemplified the best modern practice, while an eight-stage superhet. for A.C., D.C., or of universal mains type and costing 24 guineas represented good value for money.

Grafton Radio, Ltd., 79, Lols Road, Chelsea, S.W.10.

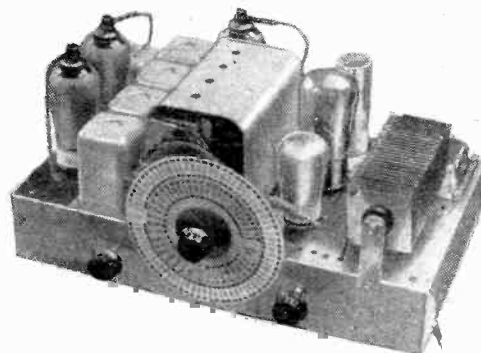

Grafton eight-stage superhet. chassis.

GRAHAM FARISH.

Even if we ignore its low price of 5s., the new Zelos variable condenser is a particularly well-made component. From the point of view of the amateur and experimenter, it has the particularly valuable feature of a removable spindle, which makes it possible to link together several of the condensers for ganged tuning. Further, for Hartley and similar circuits, where both sets of vanes are "live," the steel shaft

Olympia's Story—

may be replaced by one of insulating material to avoid hand-capacity effects.

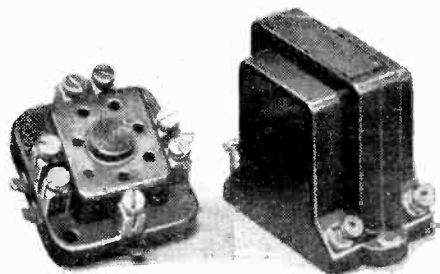

Graham-Farish 7-pin valve holder and Pip L.F. transformer.

Among other new Graham-Farish components is the Aeroficient aerial kit, which includes everything necessary for erecting an efficient aerial. There is also a new L.F. transformer, and a seven-pin valve holder.

Graham Farish, Ltd., 153, Masons Hill, Bromley, Kent.

GRAMPIAN.

This stand was devoted to moving-coil speakers of various classes, including models with multi-radio transformers and one designed specially for Class "B" amplification. With the P.M. model type P.C.X, provision is made for adding a second speaker by the inclusion of additional connections to the speaker transformer. A "Giant" model with permanent magnet is an example of a new product, whilst there is quite a selection of midget speakers.

Gramplan Reproducers, Ltd., Station Avenue, Kew Gardens, Surrey.

GRANTONA.

These exhibitors are specialists in diaphragms for loud speakers of the cone type, and can supply the greatest variety of sizes and shapes. They have thoroughly investigated the question of cone materials and methods of construction, and the whole process, from the raw material to the finished article, is carried through at their works at Stoke Newington.

R. O. Bridger and Co., 4, Shelford Place, Church Street, N.16.

GRIPSO.

Self-locking tags and sockets are a new Gripso product. These are designed so that the tag will not loosen from the socket and so result in a poor contact. Chassis-type valve-holders and a large variety of plugs, sockets, and connectors, complete the range of Gripso products.

Gripso Co., 28, Victoria Street, S.W.1.

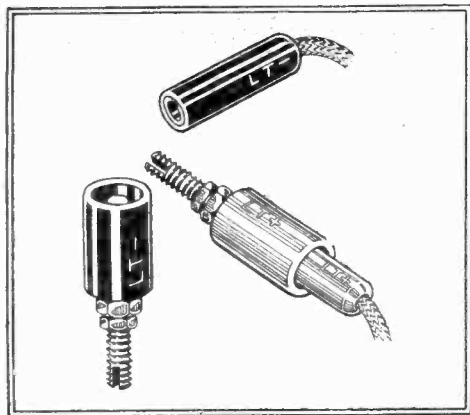

Gripso insulated plugs and sockets.

GROSVENOR.

H.T. and bias batteries for every conceivable purpose were shown on this stand.

Grosvenor Electric Batteries, Ltd., 2-3, White Street, Moorgate, E.C.2.

H.M.V.

Six new models have been introduced this year and all are superheterodynes. The new "Superhet Selective Five" at 15 guineas is a very fine example of an up-to-date inexpensive receiver possessing adequate selectivity to cope with modern

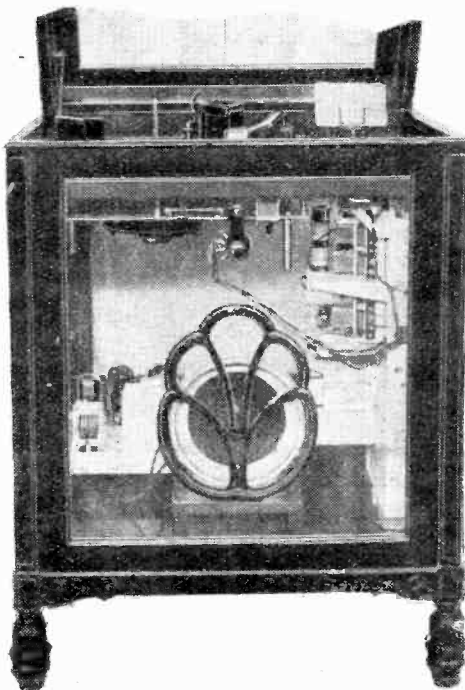

H.M.V. Superhet 10 Autoradiogram in glass cabinet, showing disposition of the units.

broadcast conditions. It embodies a four-stage circuit, the first valve combining the functions of oscillator and detector, one I.F. stage, a triode second detector and a pentode output valve delivering 1.6 watts maximum to the moving-coil loud speaker. The fifth valve is a mains rectifier.

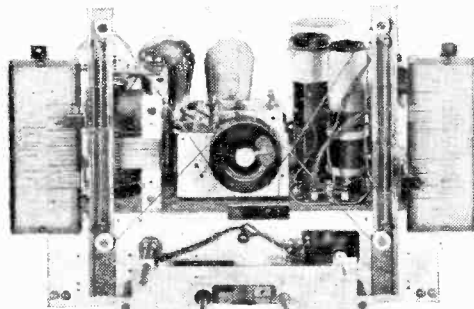

Chassis of H.M.V. Superhet Selective Five receiver.

A similar chassis is incorporated in the "Superhet Radiogram Five," the additional equipment comprising a separate volume control for the gramophone, H.M.V. pick-up and an induction-type motor, and the price is 29 guineas.

An A.C. seven-valve (including rectifier) model, the "Superhet Concert Seven" comes next in order, its special features being the inclusion of delayed A.V.C. and a manual sensitivity control described as a "static suppressor." In this case one H.F. stage precedes the frequency changer,

this function being divided between two valves. Then follows a single I.F. amplifier, two metal rectifiers, one serving as second detector and one for A.V.C., one L.F. stage, and finally a PX4 output valve. A duplex tone control operates on either the lower or the upper registers. The combined medium and long wave scale is station calibrated and the price is 22 guineas.

This is available also as a radio-gramophone at 48 guineas. Styled the "Superhet Autoradiogram Seven" it includes an automatic record changer with the capacity of eight records. Heading the list is the "Superhet-Ten Auto-radiogramophone" at 80 guineas. It is based on last season's model, but in its new form incorporates delayed A.V.C. and sundry other refinements. As a de-luxe model the price is 95 guineas.

A few of the well-tried H.M.V. sets are retained with slight modification. The Superhet Portable Six, for example, is now fitted with a moving-coil loud speaker and, in addition, the price is reduced to 14 guineas.

Gramophone Co., Ltd., 98, Clerkenwell Road, E.C.1.

HACKER.

The twelve-valve Ether Emperor occupied pride of place on this stand; it is a straight set with three H.F. stages and six tuned circuits of the iron-core type. A diode detector with an L.F. stage feeding the push-pull output stage is used, and separate H.T. supplies are provided for the H.F. and

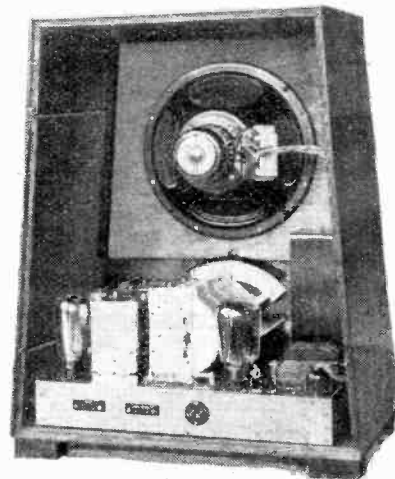

"Two-H.F." Commodore receiver with A.V.C. and iron-core coils.

L.F. valves. The delayed A.V.C. system is unusual in that a special H.F. stage is provided to feed a metal rectifier for providing the bias voltages. An autodyne frequency changer is included to permit short-wave reception.

A smaller receiver, the Commodore, is priced at 18 guineas and is arranged for A.C. or D.C. mains operation. This has two H.F. stages with iron-core coils and delayed A.V.C. Many other models, including battery sets, were shown.

H. Hacker and Sons, Perfecta Works, Ray Lea Road, Maidenhead.

HALFORD.

One of the chief features on the Halford stand was the Telecontrol system of remote control. A small unit containing two control knobs and the calibrated tuning scales is used and connected by flexible leads to the receiver proper. Tuning and volume can both be controlled from a distant point.

Olympia's Story—

Two superheterodyne models were shown; the seven-valve type being equipped with an H.F. stage preceding the detector-oscillator and a push-pull pentode output stage,

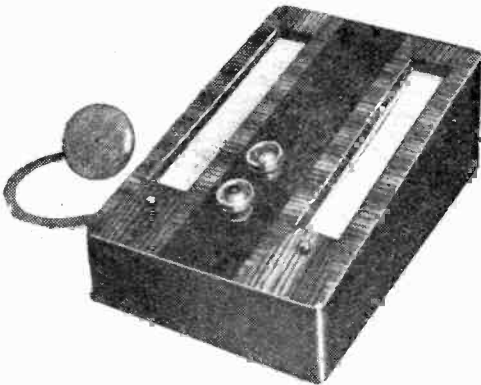

Halford "Telecontrol" remote-control unit.

and the five-valve model not having these features. The all-wave models employ these basic chassis, but include in addition a two-valve converter which is arranged to have an aperiodic H.F. stage before the autodyne frequency changer in order to prevent aerial radiation. The All-Wave Seven, Model 40, is priced at 30 guineas.

Halford Radio, Ltd., 39, Sackville Street, W.1.

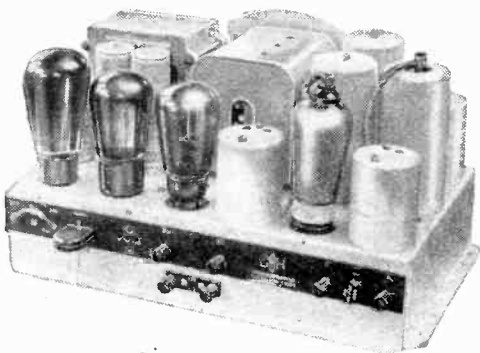

Chassis of the Halford Berkeley superheterodyne.

HARLIE.

A useful selection of accessories were shown on this stand. Amongst them should be mentioned the "Fix-a-gram" playing desk consisting of gramophone motor and pick-up in a convenient cabinet suitable for using as a base on which to stand the set.

The Harlie pick-up with volume control incorporated and a tone selector or scratch filter are other useful components, the latter being used either as an accessory to the speaker or to the pick-up, depending upon which purpose it is required to meet.

Harlie, Ltd., Balham Road, Lower Ed-
monton, N.9.

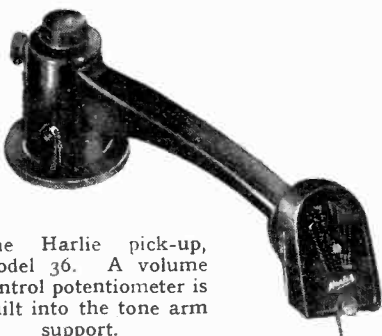

The Harlie pick-up, model 36. A volume control potentiometer is built into the tone arm support.

HAYNES RADIO.

Haynes receivers are designed to appeal to the knowledgeable and discriminating enthusiast rather than to the listener whose main concern is cabinet work. Apart from the fact that they are produced as sets of parts, bare chassis, or in completed form, they are flexible, being devised for working with alternative output units, and with single or dual speakers.

Although it is not entirely new, and does not include the most "fashionable" of circuits, the Haynes A.C. Quality Receiver may first be described. Giving an undistorted output of six watts, it embodies three tuned circuits with Ferrocarts coils,

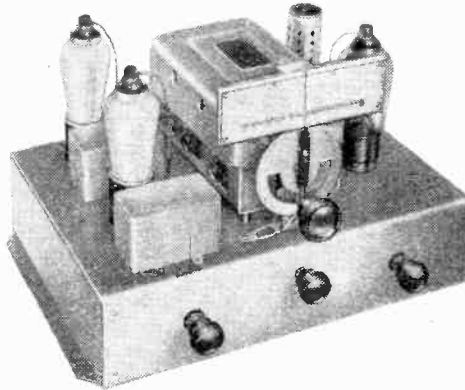

Haynes Radio superheterodyne receiver.

one H.F. stage, and two resistance-coupled L.F. stages. Such an arrangement is almost ideal for medium range and high-quality reproduction, and the set may be expected to show a considerably improved performance as compared with its predecessor.

The A.C. superheterodyne has either a two-valve or Pentagrid frequency changer, I.F. stage and a double-diode second detector giving amplified and delayed A.V.C. Ferrocarts coils are used throughout, including new I.F. transformers designed to give a straight-sided resonance curve. A similar D.C. model was shown.

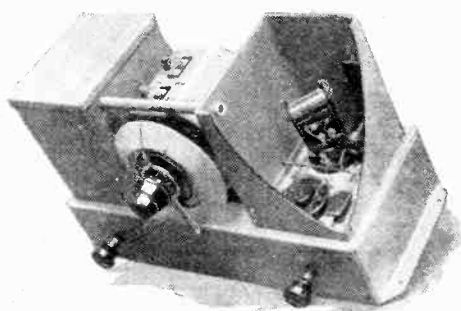

Haynes Radio short-wave superheterodyne converter.

A short-wave superheterodyne, two Class "B" battery receivers, a three-valve A.C. set, and a particularly workmanlike short-wave converter complete the list of main exhibits.

Haynes Radio, 57, Hatton Garden, E.C.1.

HEYBERD.

Among the several new items were two portable power amplifiers of five- and ten-watt rating respectively. Each model incorporates two stages and a valve rectifier. The controls are neatly arranged on a polished bakelite panel and the prices are £19 10s. for the H5 and £23 5s. for the H.10.

Portable battery chargers and one for home use are also new. Model AO.3 charges 2-, 6- or 12-volt batteries at one amp. and the price is 42s. 6d.

Heyberd mains transformers have been modified, plugs and sockets now being employed largely in place of terminals and a colour code is adopted.

F. C. Heyberd and Co., 10, Finsbury Street, E.C.2.



Heyberd type H.10 portable two-stage amplifier.

HELLESENS.

It is good news for battery users to hear that the

Hi-Life series of Hellesen batteries, now sold at greatly reduced prices, include exactly the same type of cell as their original productions. As an example of prices, the 120-volt standard capacity now costs 11s.

A new and improved patented cell is employed in the "Super" batteries; in this series the 120-volt pattern costs 14s.

It is interesting to note that Hellesen batteries are now fitted in Aerodyne, Atlas, Cromwell, Ekco, Murphy, and Pye receivers.

In addition to the H.T. batteries, Hellesen's also make dry and wet electrolytic condensers of the high- and low-voltage types.

Hellesens, Ltd., Morden Road, S. Wimbledon, S.W.19.

HENLEY'S.

Although wire of various kinds formed a large portion of this exhibit, the chief feature was the Solon electric soldering iron, which is priced at 7s. 6d.

Henley's Telegraph Works Co., Ltd., 11, Holborn Viaduct, E.C.1.

HIGGS

Six-valve superheterodynes were to be found on this stand, and the A.C., D.C., and battery models are all priced at 18 guineas. They are essentially similar, and include band-pass input to the two-valve frequency changer, a single I.F. stage, an anode bend second detector from which A.V.C. is arranged, coupled in the case of the mains models to an output pentode, and in the case of the battery type to the driver which in turn feeds the Class "B" output stage. A universal A.C./D.C. type is also available at 20 guineas.

Higgs (Gt. Britain), Ltd., Westbourne Place, Hove, Sussex.

HIVAC.

The activities of this firm are devoted exclusively to the manufacture of an inexpensive range of 2-volt valves. Entirely British made, they include models of every type, the most recent additions being two pentode equivalents, the Y220 and the Z220, priced at 12s. 6d. each and giving power outputs of 500 and 750 milliwatts respectively. Also a Class "B" type, the B220, rated at 1,250 milliwatts output with

Olympia's Story—

an anode-to-anode load of 14,500 ohms. The price is 10s. 6d.

High Vacuum Valve Co., Ltd., 113, Farringdon Road, E.C.1.

IGRANIC.

While several of last season's models are retained, so many new components have been introduced that, on the whole, the Igranic range may be regarded as almost entirely new. A series of iron-cored coils occupy a prominent position. A closed magnetic circuit consisting of "E" and "I" laminations is employed, and the windings are carried on a sectionalised former. Five different styles are available covering the requirements of straight as well as of superheterodyne receivers, while, in addition, there is one dual range short-wave coil in the Igranic series. Wave-band switching is included. Single coils cost 12s. 6d. each, while a three-coil assembly comprising band-pass aerial and H.F. coils is priced at 36s.

A complete tuning unit, described as the Igranipak and consisting of a stout steel chassis carrying a three-gang condenser, three air-cored screened dual-wave coils, three five-pin valve holders and all the essential components for the H.F.-det. portion of a two-H.F. receiver, was shown, and the price is 57s. 6d.

Tubular condensers, paper-dielectric smoothing condensers in metal cases, toggle switches, Class "B" driver transformers, differential and reaction condensers constitute a few of the new items now available at prices which are very competitive.

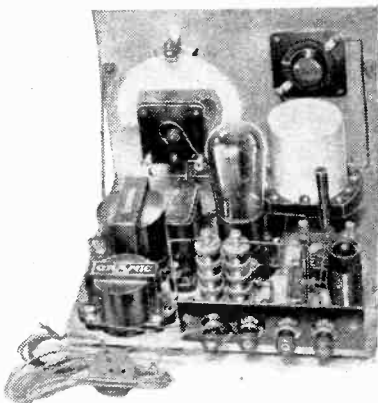

Igranic short-wave adaptor chassis.

A new smoothing choke has been introduced to replace the model CH2. Rated at 40 henrys and to carry 40 mA., it costs 9s. 6d. A buttonhole transverse current microphone measuring 2 1/4 in. in diameter, 3/4 in. deep and weighing 3oz., will be found extremely useful for public address as well as for many other purposes, for, despite its small size, it will carry up to 25 mA.

Igranic Electric Co., Ltd., 147, Queen Victoria Street, E.C.4.

ITONIA.

In addition to the products of the manufacturers for which this firm are factors the Itonia Playing Table and Playing Bureau, by means of which a transportable receiver may be converted to a radio-gramophone, were demonstrated.

Itonia, Ltd., 58, City Road, E.C.1.

J.B.

The Superhet gang condensers are the latest addition to the J.B. range. Based on

last season's Nugang type, their only difference is that one section, which can be either the front or the back according to requirements, is fitted with tracking vanes in the stator. A three-gang model costs 21s. with dust cover.

This year a feature was made of a new range of dials, one model incorporating a hair-line cursor moving close to the scale. The dial light travels with it, so giving the maximum illumination where it is most useful. Known as the type S.L.1, the price is 6s. 6d. Fitted with a switch for economy in battery sets it becomes the model S.L.2 at 7s. 6d.

Another new J.B. product takes the form of a complete tuning unit described as the "Linacore." It consists of a three-gang condenser, three iron-cored coils, and costs 69s. 6d.

Jackson Bros. (London), Ltd., 72, St. Thomas Street, S.E.1.

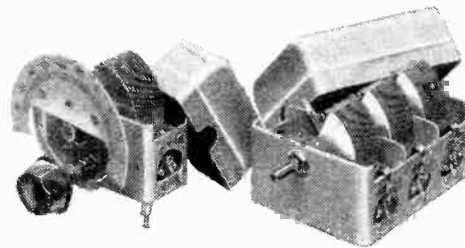

A pair of J.B. Nugang condensers.

KENSINGTON.

A series of cabinets for radio receivers, and particularly for radio-gramophones, comprised the exhibit of this firm. These included cabinet stands for portable sets, and also a record-playing cabinet comprising an electric motor turntable on a hinged base and record storage space.

Kensington, Ltd., 196, Upton Lane, Forest Gate, E.7.

KOLSTER-BRANDES.

The model 444 shown by this firm is interesting as exhibiting the reductions which can be made in superheterodyne design. Apart from the rectifier, only three valves are used, as detector-oscillator, second detector, and output. Fixed reaction is provided from the second detector to the I.F. coupling, and the set is priced at 11 guineas. The model 666 has a signal frequency H.F. stage preceding the detector-oscillator, and there is an I.F. valve, so that its sensitivity is considerably higher; this set is priced at 15 guineas. The model 888 is essentially similar to the 666, and also includes A.V.C.,

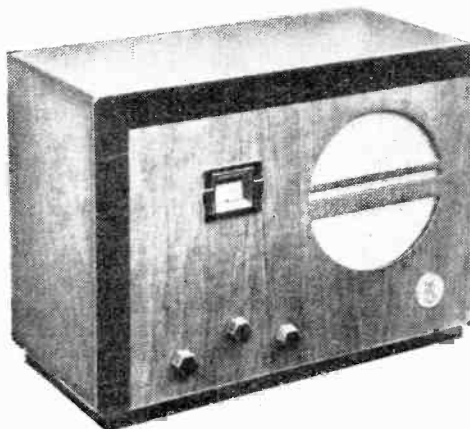

Kolster-Brandes model 444 three-valve superheterodyne.

but this is fitted with a "quiet" control, and there is a push-pull output stage. It is listed at £26 5s. A number of battery and

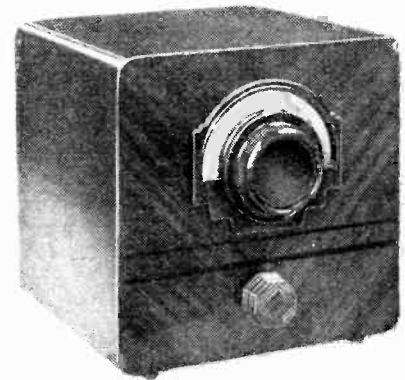

Kolster-Brandes short-wave converter.

mains operated straight sets was also on view. A short-wave converter intended chiefly for use with Kolster-Brandes mains sets, and taking its power from them, was shown at 3 guineas.

The Rejctostatic units were being specially featured. These consist of aperiodic transformers for use in conjunction with a screened aerial down-lead for the elimination of local interference. A pair of units is employed, one being mounted on the aerial itself to match the aerial to the screened lead-in, and the other by the receiver to match the lead-in to the set; they are priced at £1. Special shielded cable for use with them is available at 4 1/2d. per yard. All Kolster-Brandes receivers are specially equipped for this system.

Kolster-Brandes, Ltd., Cray Works, Sidcup, Kent.

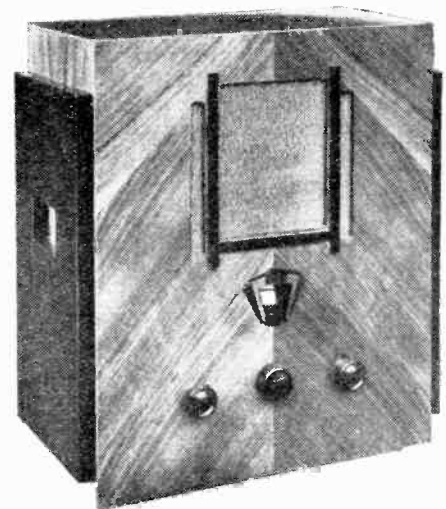

The Phantom S.G.4 receiver, by Lampex.

LAMPEX.

On this stand the principal exhibit was the 1934 Phantom "S.G.4" with Class "B" output. Other sets shown were a cheaper model of the Phantom S.G.4 without Class "B" stage, and the "Phantom Minx" three-valve battery set, priced at £3 10s., or, with moving-coil speaker, five guineas.

Lampex Radio and Electric Co., 62, Brewery Road, Islington, N.7.

LAMPLUGH.

In the Lamplugh programme for this season new products have been added to their usual lines. One of these is an "Anti-stat" aerial unit for reducing local elec-

Olympia's Story—

trical interference, and consists of a shielded down-lead, where the shield can be tuned to the frequency of the interference. Special advantages are claimed for this arrangement.

A new baffle, the "Silver Ghost Timpani Tone," is another innovation. Moving-coil speakers still remain the principal products, electro-magnet and permanent-magnet types with diaphragms of 12in., 10in., and 8in. diameters being available. The Farrand inductor speaker is also retained.

Lamplugh Radio, Ltd., 177, Foleshill Road, Coventry.



Silver Ghost Senior P.M. speaker.

LION.

The outstanding feature of this exhibit was the particularly wide range of H.T. and grid-bias batteries, but an eliminator having four positive tappings and giving 150 volts at 25 mA. maximum was shown also.

Vince's Dry Batteries, Ltd., Lion Works, Garford Street, E.14.

LISSEN.

This year's kit set programme is particularly attractive and ambitious. The All-wave Skyscraper Four, on a steel chassis, embodies an H.F. stage, a screen-grid detector, and two pentodes in the Q.P.P. output circuit. The most unusual feature of the set is that it covers four wave ranges (from 12 to 2,000 metres) with the help of shielded tuning coils, and a special switching system. Another feature is a combined volume control and reaction device, in which both functions are effected by a single knob. Complete with Lissen valves, the kit costs £5 12s. 6d.

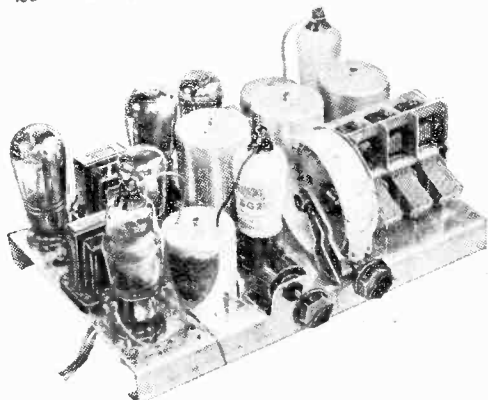

Lissen superheterodyne kit set.

Another interesting kit is the Safety A.C. Skyscraper, in which the difficulties in preparing a set of parts for the construction of a mains set by the totally unskilled have been ingeniously overcome; the mains equipment is contained in a separately screened unit. The set embodies an H.F.

det.-I.F. circuit with ganged tuning system. The most ambitious of all the kits is a superheterodyne for battery operation, in

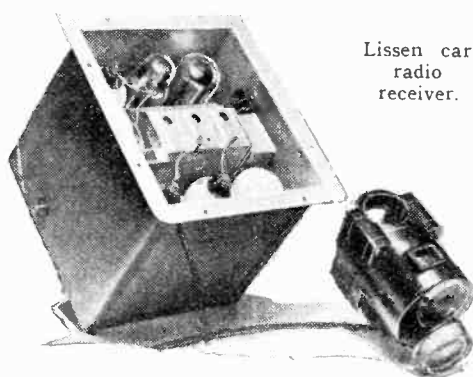

Lissen car radio receiver.

which seven valves, including Class "B" output, are employed.

Lissen has also produced a motor car set of workmanlike design, enclosed in a robust weatherproof metal case, and arranged for remote control from the steering column. Tuning is cable-operated, and both wave-ranges are covered.

Among the complete sets produced for this season is a five-valve transportable with a frame aerial, which is stated to possess high selectivity even when an external aerial is added. The latest three-valve A.C. or D.C. model is mounted in a modern type of horizontal cabinet, and is fitted with a pentode output valve.

Lissen, Ltd., Worple Road, Isleworth, Middlesex.

M.P.R.

A series of mains units for both A.C. and D.C. supply, with outputs up to 30 milliamps, represents the main activities of this firm. All include the unusual feature of a safety fuse, and the A.C. models are available with a built-in ½-amp. trickle charger.

Mains Power Radio, Ltd., Broadway Works, Eastern Road, Romford, Essex.

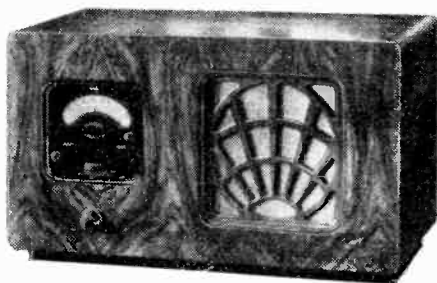

McMichael Lodex Class "B" receiver.

McMICHAEL.

Modern tendencies in "straight" set design are well exemplified in this year's McMichael programme. In many respects the most ambitious model is the Twin Supervox, in which dual matched loud speakers are mounted in a horizontal type cabinet. The receiver chassis itself embodies two H.F. stages, followed by a triode detector and a pentode output valve of the Catkin type. Tone control is fitted, but there is no reaction. Mechanically the design is ingenious, and in spite of the fact that two loud speakers are fitted the set is by no means bulky.

The improved Duplex Mains Four will appeal especially to those who find it impossible to erect an aerial. This set has a self-contained frame and embodies a two-H.F. circuit with one aperiodic stage, a de-

detector and pentode output; it is for A.C. mains operation, and is one of the very few sets of this type to be fitted with a frame.

The Lodex Five is an exceptionally ambitious battery set of modern design with two H.F. stages, detector, a driver, and a Class "B" output stage.

Other McMichael sets include the Duplex Super Five, in a vertical cabinet, the Duplex Four cabinet portable; and last, but not least, the well-known Suitcase Portable model, which now includes a moving-coil loud speaker.

McMichael Radio, Ltd., Wexham Road, Slough, Bucks.

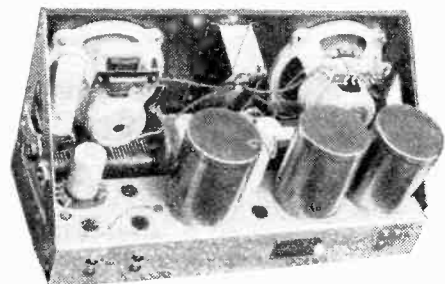

Chassis of McMichael Twin Supervox.

MACOVOX.

Apart from manufacturers' products which forms the wholesale section of this firm's activities, a special feature was made this year of a range of Macovox receivers, the Universal Five being of particular interest in that it is suitable for operation on A.C. or D.C. mains. A superheterodyne circuit is employed, and the price is 12 guineas. The range includes several battery models.

Manufacturers' Accessories Co., 85, Great Eastern Street, E.C.2.

MAGNACORE.

On this stand was shown a range of L.F. and Class "B" type transformers at prices ranging from 4s. to 7s. 6d.

Magnacore, Ltd., 85, Alsen Road, Holloway, N.7.

MARCONIPHONE.

This year's Marconiphone programme is extraordinarily complete, and it is indeed difficult to avoid making invidious comparisons by picking out any particular set for special mention. Probably, however, the two superheterodynes are best representative of modern tendencies.

The smaller Model 272, costing 15 guineas, includes peaked band-pass tuning, followed by an S.G. detector-oscillator, an I.F. amplifier, a power grid second detector, and

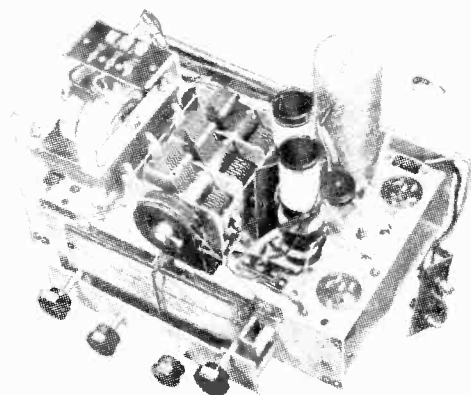

Marconiphone Model 272 superheterodyne chassis.

Olympia's Story—

pentode output. Although quality is stated to have been specially aimed at in the design, sensitivity has not been neglected, and adjacent channel selectivity is claimed.

Model 276 superheterodyne with six valves and a rectifier has, as compared with the preceding set, an additional signal frequency H.F. stage and a separate oscillator. Delayed A.V.C. is fitted, and there is a noise suppressor which can be put to use at will for reducing sensitivity to a predetermined level.

Then there is the battery set Model 260, a lineal descendant of the three-valve set so favourably reviewed last year in *The Wireless World*. The one weakness of the earlier set—a limited output and "battery-set" quality of reproduction—has been overcome by fitting a system of Q.P.P. amplification and a moving-coil loud speaker.

Other Marconiphone receivers include "straight" sets and radio-gramophones for A.C. and D.C., and radio-gramophones with and without automatic record changing.

All the latest developments are represented in this season's Marconi valves. It is difficult to pick out the high lights, but mention should be made of the battery H.F. pentode; this valve should be useful in battery-fed sets of the more ambitious type.

The Class "B" valve, Type B 2r, has exceptionally good characteristics, and for the H.F. stage of the modern set the short-base variable-mu battery valve type VS 24 will prove a good choice. Where battery economy is vital the S 23, of which the anode consumption averages less than a milliamp, has particular attractions.

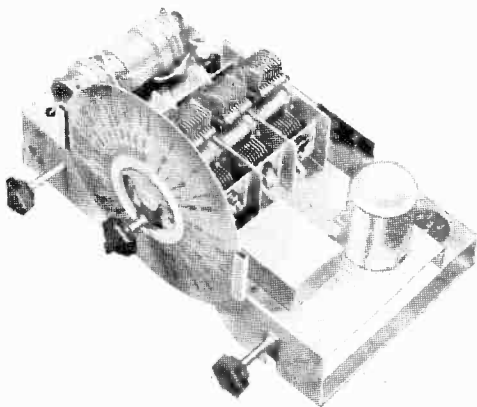

Marconiphone Q.P.P. battery receiver, type 260.

Turning to mains valves, the new MPT 4r, with a conductance of 5.5, has extraordinarily high sensitivity; it should be mentioned that the conductance figure given applies to the valve when operated at the rated working conditions.

The recently introduced unbreakable Catkin valves must not be forgotten, and, lastly, there are indirectly heated rectifiers of the B and C class which confer important advantages in avoiding voltage rises during the warming-up period.

Marconiphone Co., Ltd., 210, Tottenham Court Road, W.1.

METAL AGENCIES CO.

This stand was devoted to a display of "Drymac" H.T. batteries and "Starmac" mass-type accumulators. The 120-volt standard capacity H.T. unit, at 8s. 6d., and the 45 A.H. glass accumulator at 3s. 6d., are indicative of good value.

Metal Agencies Co., Ltd., Queen Square, Bristol.

MILNES RADIO CO.

This firm are manufacturers of a range of H.T. accumulators incorporating nickel-cadmium plates immersed in an alkaline solution. Standard and double-capacity types are now made; the former range includes five models from 90 volts at £3 3s. to 180 volts at £6 10s. There are four double-capacity units, these range from 120 volts costing £6 3s. to 200 volts, the price of which is £10 3s.

Each model embodies a switch which places banks of cells either in series or in parallel, and in the latter position the unit can be charged from a 6-volt accumulator.

Milnes Radio Co., Victoria Works, Church Street, Bingley, Yorks.

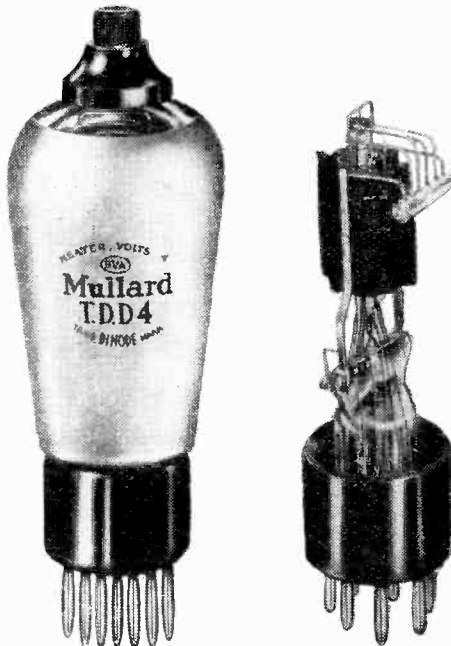

(Left) The Mullard T.D.D.4 duo-diode-triode and (right) the new Pen.4VA, showing the electrode assembly.

MULLARD.

Class "B" valves formed a prominent feature of this exhibit, and the PM.2B is rated for working with a 14,000 ohms load impedance. The P.M.2DX is recommended as a driver, and an input of 3 volts R.M.S. to this valve is sufficient for full output. In the A.C. range, screened H.F. pentodes have been introduced, and the S.P.4 is of the non-variable-mu type, and is intended for use as a detector-oscillator, an H.F.

amplifier, or a detector. The V.P.4 is of the variable-mu type, and is rated for 100 volts screen potential, with which it has a grid base of about 40 volts; by reducing the screen potential it may be used as a short-base type valve.

A duo-diode-triode, the T.D.D.4, is intended chiefly for automatic volume control purposes, and there is a single-diode-tetrode, the S.D.4, for which numerous applications can be found, particularly in obtaining Q.A.V.C. A new indirectly heated output pentode, the Pen.4VA, is rated for an output of over 3 watts, with an anode current of only 32 mA., while the ACo44 has been modified for use with 250 volts anode supply, and will now give an output of 2½ watts.

A range of D.C. mains valves has been introduced; H.F. pentodes of the ordinary and variable-mu types, a triode detector, and a pentode output valve all have heaters rated for 20 volts at 0.18 ampere, while the duo-diode-triode is rated for 25 volts at the same current.

A wide range of H.T. rectifier valves was also shown.

Mullard Wireless Service Co., Ltd., Mullard House, Charing Cross Road, W.C.2.

MULTITONE.

The latest Multitone production is a wireless receiver which is at the same time a valuable aid to the deaf or even to those who are hard of hearing. The set itself is of the battery-operated transportable type with a frame aerial, and includes five valves with two tuned H.F. stages and Class "B" output; there is no reaction, and it is hardly necessary to say that complete tone control is provided.

In addition to performing its normal functions as a wireless receiver, the set has a special "parallel" output to permit of simultaneous headphone reception by a deaf person. For this purpose there is an independent volume control which has no effect upon reproduction through the loud speaker. Special headphone receivers for different types of deafness are provided.

But this does not exhaust the possibilities of the set. When wireless reception is not required it may be converted, by turning a switch, into a deaf-aid amplifier; the loud speaker then acts as a sensitive microphone.

Interesting as is this new development, we must not lose sight of the Multitone transformers, which afford a really practical and

convenient method of tone control in any type of receiver. Still more types are now available, including special designs for interposing between a microphone and an amplifier. There are also special Multitone transformers for the latest systems of economical battery-set operation, and also a tapped output choke which "matches anything to everything."

Multitone Electric Co., Ltd., 95, White Lion Street, Islington, N.1.



Multitone "Wireless for the Deaf" receiver-amplifier.

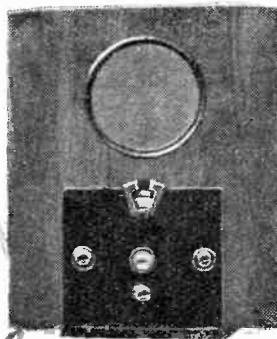

NUVOLION.

New additions to the range of Nuvolion moving-coil speakers were shown here, and a point of special interest was the display

Olympia's Story—

of response curves of speakers on the stand. A feature of these speakers is a seamless cone, made by a process in which

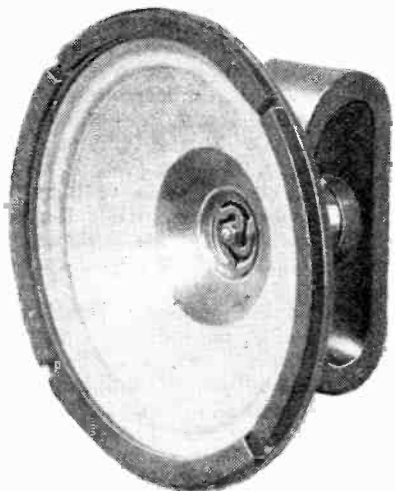

The Nuvolion speaker, type P.M./L, with specially designed cone.

the speech coil and the apex of the cone are treated to form a rigid whole.

Nuvolion Electrics, Ltd., Meredith Yard, Park Crescent, Clapham Park Road, S.W.4.

OLDHAM.

Oldham batteries are retained in much the same form as last season, but a few changes have been made in the nomenclature. The type CLG with interleaved plates for heavy discharge is now known as the "Plus" series, the sizes being Plus 75, Plus 100, Plus 125, and Plus 150. In the slow discharge range the 075 model is now dropped, the 050 and 025 being retained, but the price of the last mentioned is now reduced to 5s.

"Lively O" dry batteries were well represented, the range of replacement models for the more popular receivers now being very extensive indeed.

Oldham and Son, Ltd., Denton, Manchester.

ORMOND.

A range of moving-coil loud speakers of the now popular miniature type, also larger models and a varied selection of components that will serve many requirements of the set

Ormond model R/475CT P.M. speaker chassis.

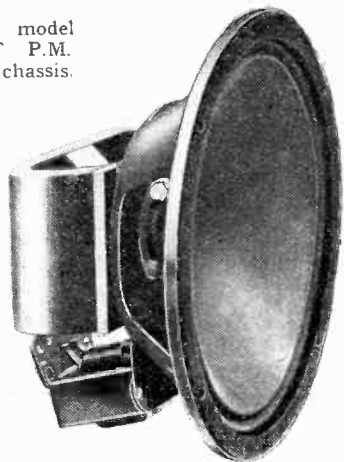

builder, constituted the principal exhibits on this stand. There is a new disc drive at 2s. 6d.; a range of volume controls from 5,000 ohms to 50,000 ohms at 3s. 6d. each; Q.P.P. input transformers at 7s. 6d., and

a new short-wave condenser of 0.00013 mfd. incorporating a 50 to 1 reduction drive at 7s. 6d.

P.M. moving-coil loud speakers were shown from 26s. upwards in chassis form; in a cabinet, and described as the model R.495, the price is 40s. A well-made medium-priced P.M. unit is the R.475, costing 38s. 6d. All standard models are fitted with three-ratio input transformers, but they are available also with transformers to suit push-pull output valves.

Ormond Engineering Co., Ltd., Ormond House, Rosebery Avenue, E.C.1.

ORR RADIO.

The most interesting feature of this stand was a four-valve (and valve rectifier) superhet. for D.C. working, and a Class "B"

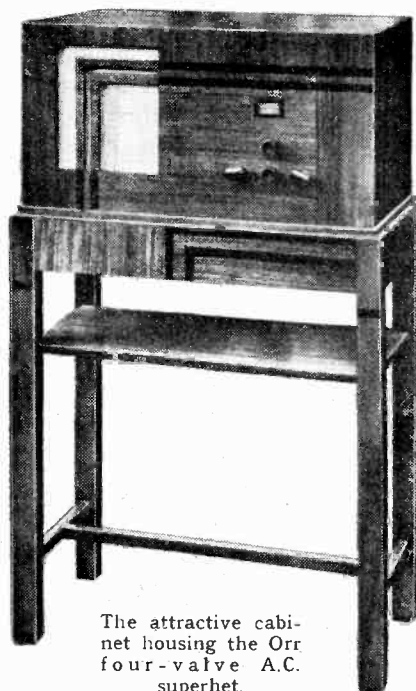

The attractive cabinet housing the Orr four-valve A.C. superhet.

battery set. Several other less ambitious sets at low prices were also shown.

Orr Radio, Ltd., 63, Lincoln's Inn Fields, W.C.2.

OSBORN.

This was a cabinet display and some very striking and attractive designs were to be seen. One of these, No. 253, is in the new horizontal style with the speaker location alongside the controls. All the cabinets seemed remarkably low priced for the quality shown.

Chas. A. Osborn, Regent Works, Arlington Street, N.1.

OSDUR MANUFACTURING CO.

The "Billo" static cut-out, which is claimed to eliminate interference and atmospheric, was shown on this stand at the price of 12s. 6d.

Osdur Manufacturing Co., 26, Adam Street, W.1.

PAGE CAR RADIO.

Of the three motor-car sets produced by this firm, the most interesting is undoubtedly a highly specialised five-valve superheterodyne, entirely designed for its special purpose. It is extraordinarily compact and serviceable, being assembled on a baseplate measuring only 5½ in. by 8 in., and is completely enclosed in a special water-

tight steel container for fitting in an inverted position below the floorboards.

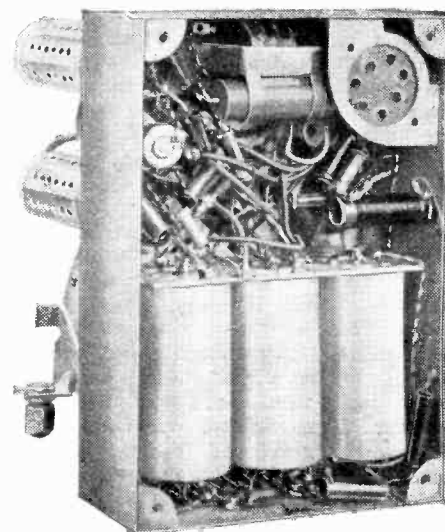

Under-side of Page Car Radio superheterodyne.

Low-tension current for the five Catkin valves, of which the heaters are connected in series-parallel, is obtained from the car battery. The circuit arrangement comprises an H.F. stage, an S.G. frequency changer, one I.F. stage, a triode detector, and pentode output. A.V.C. is provided by a Westector, and remote manual control is effected through a unit mounted on the steering column. A rotary H.T. generator and a miniature moving-coil loud speaker, energised by the car battery, completes the equipment.

A second set, with direct control, is intended for mounting on the instrument board, and includes an H.F.-det.-L.F. three-valve circuit. The cheapest model is for headphone reception only, and employs two four-electrode valves operating as detector and L.F. amplifier.

Page Car Radio, Ltd., 55, Windsor House, Victoria Street, S.W.1.



Pertrix 120-volt battery for Class "B" sets.

PERTRIX.

Manufacturers of Pertrix batteries, this firm has a full range of H.T., grid bias, and L.T. batteries. There are some six different H.T. types, ranging in size from standard to super heavy duty models, the former being rated for less than 10 mA. discharge, while from the last mentioned up to 45 mA. can be taken. Intermediate capacities to meet all requirements and at prices to suit all are available. They are 8s. for a 60-volt standard model, 15s. 6d. for a 120-volt Ultra model (suitable for Class "B"), and 24s. for the Super-Capacity 120-volt battery.

L.T. accumulators are made in a wide range of styles; gravity floats are incorporated in many models, while both heavy duty

Olympia's Story—
and slow discharge types are included in the range.

Britannia Batteries, Ltd., 233, Shaftesbury Avenue, W.C.2.

PHILIPS.

The "star" exhibit was the new Model 636A—a "straight" receiver comparable in specification and technical design with the most advanced of modern superheterodynes. It has no less than seven stages, as follow: Two tuned H.F. stages with band-pass input, screen grid detector, single diode S.G. for A.V.C., triode for silent tuning, triode L.F. amplifier, and seven-watt output pentode. In addition to the combined tuning

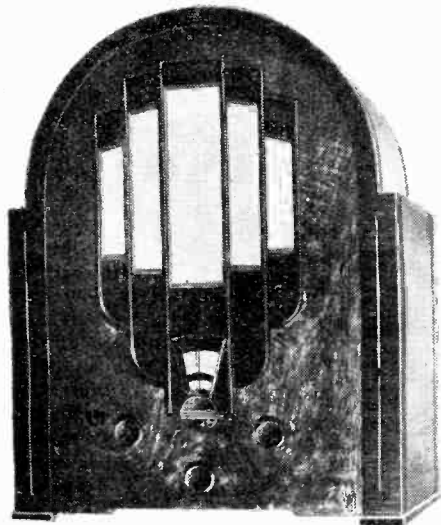

Philips "straight" receiver, the Model 636A, with interesting features, including A.V.C.

and wave-range, and manual volume control, there is a sensitivity control giving three distinct ranges of overall magnification. The maximum possible performance with absence of background noise can thus be obtained under any conditions of local interference. This set is designed for A.C. mains only, and costs 23 guineas.

The Model 634 is identical with the above receiver as regards the H.F. stages. It has, however, a simplified form of A.V.C. and the diode-S.G. detector is followed directly by the output stage, making four stages in all. This model is made for D.C. as well as A.C. mains, the prices being 17 guineas and 16 guineas respectively.

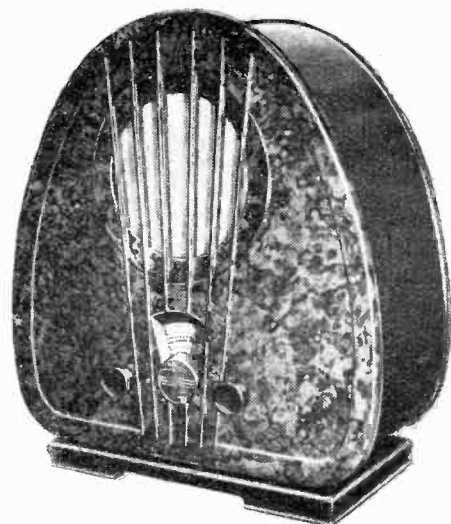

Philips Model 834, a new receiver with two H.F. stages.

In the Model 834 there are again two screen grid H.F. stages, but the second is semi-aperiodic, and is followed by a high magnification triode detector and an output stage. For A.C. mains the price is 11 guineas, and for D.C. 12 guineas.

In all Philips sets designed for D.C. mains two pentodes in parallel are used in the output stage. By this arrangement adequate volume is obtained on supply voltages as low as 110.

Battery-operated sets were represented on this stand by the Model 832B, in which a separate valve is used to regulate the H.T. supply to the power valve. This is essentially the Model 830B of last year, but a moving-coil loud speaker has been fitted and the cabinet has been redesigned. The price complete is 10 guineas.

Philips Lamps, Ltd., 145, Charing Cross Road, W.C.2.

PIX.

In addition to a wider range of Pix valves, now including two- and four-volt types, A.C. mains and mains rectifiers, this firm were featuring the Pix aerial selectivity device, costing 2s., and the recently introduced invisible aerial for indoor use, a 30-foot reel of which costs 2s.

British Pix Co., Ltd., 118, Southwark Street, S.E.1.

POLAR.

Of the several new additions to the Polar range of condensers the most interesting is the new Star Minor series. Compactness, rigidity of construction, and close matching between sections constitute their principal features.

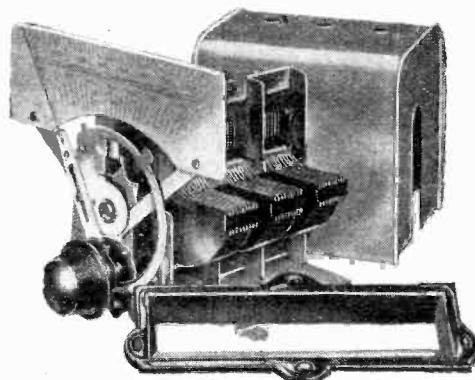

Polar Star Minor condenser with new horizontal scale.

Two-, three-, and four-gang types are made, also a range of superhet. condensers fitted with a tracking section designed for 110 kc/s. I.F. amplifiers. All sections are matched to within 1/2 per cent. or one mmfd., and a three-gang model costs 18s. 9d. in either style.

New slow-motion condenser drives are now available; these take the form of full vision disc and drum patterns. The range includes six different styles, three are full-vision drives, two are disc models, and one is a drum pattern. The majority are fitted with a wavelength calibrated scale, all have dial lamps, while certain models can be obtained fitted with a small air-dielectric trimmer condenser operated by a knob concentric with the main tuning control. The full-vision pattern cost 5s. 9d. each, or with trimmer 7s. 9d.

Short-wave condensers and a range of pre-set models designated Capacitors are new this season.

Wingrove and Rogers, Ltd., Mill Lane, Old Swan, Liverpool.

PORTADYNE.

An interesting and up-to-date self contained transportable receiver—the P.B. model—was exhibited by Portadyne. This set includes one H.F. stage and Class "B" amplification feeding into a moving-coil loud speaker. An undistorted out-

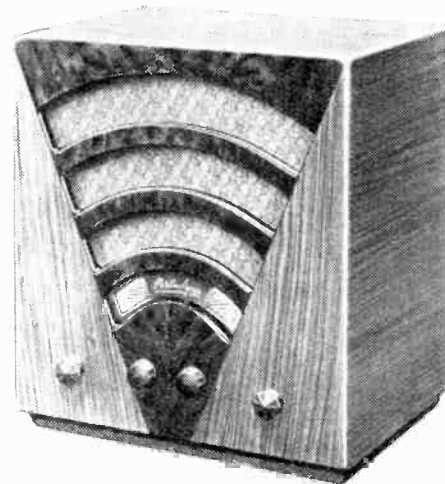

Portadyne superheterodyne receiver.

put of 1,300 milliwatts is claimed, and the average H.T. consumption is stated not to exceed some 10 milliamps. Gramophone pick-up sockets, which are a really useful addition with Class "B" amplification, are fitted.

Open-aerial sets are now being produced, as well as portables. There are two new superheterodynes, one for battery and the other for A.C. mains operation; both employ a somewhat similar circuit arrangement. The A.C. set has a combined detector-oscillator, variable-mu I.F. stage, a double-diode triode as second detector, which provides automatic volume control, and a pentode output valve, with valve rectification. The battery set employs Class "B" output and a compensator for fading effects.

Portadyne Radio, Portadyne Works, Gorst Road, N.W.10.

POWERTONE PRODUCTS.

On this stand three types of suitcase portable sets were displayed. Prices

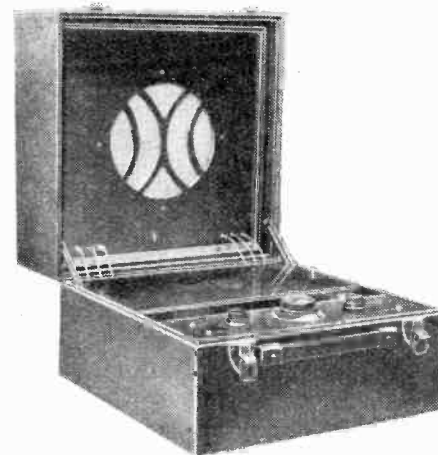

One of the Powertone range of suitcase portables.

of these sets were particularly low, and they should therefore make a popular appeal.

Powertone Products, 88a. Cromer Street, W.C.1.

Olympia's Story—

PYE.

The P/AC portable receiver, which was shown on this stand, is an A.C. superheterodyne with a built-in frame aerial. H.F. and I.F. stages are used with a detector-oscillator, and a duo-diode-triode second

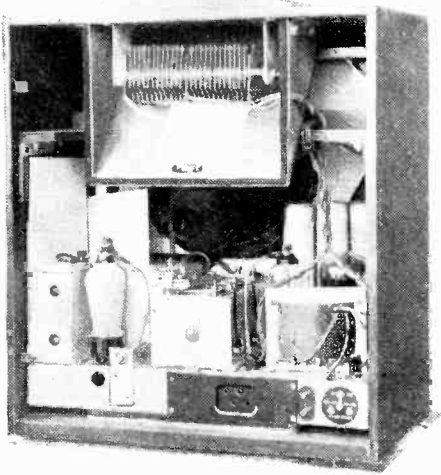

Pye P/AC superheterodyne transportable for A.C. mains.

detector provides A.V.C.; the output pentode is rated to deliver 1½ watts to the speaker, and a metal rectifier is used for the H.T. supply. The P/B portable is of the battery type, and in this A.V.C. is arranged with the aid of Westectors; there is a Class "B" output stage. The A.C. set is priced at 15 guineas, and the battery model at 14 guineas.

Similar type superheterodynes, at the same prices, are available for use with an outdoor aerial, and these are listed as models E/AC and E/B. The "S" model superheterodyne is being retained at 22 guineas.

A number of small straight sets was also shown, and the "G" series is available for A.C., D.C., or battery operation at 12 guineas. The battery set is fitted with a Q.P.P. output stage. A two-valve set with a band-pass tuning circuit is available at 8 guineas in an A.C. type.

Pye Radio, Ltd., Africa House, Kingsway, W.C.2.

R. & A.

The new "Alpha" permanent magnet moving-coil unit attracted very favourable comment, not only on account of the well-thought-out diaphragm mounting, but also for the generous design of the magnet system and output transformer. The diaphragm is

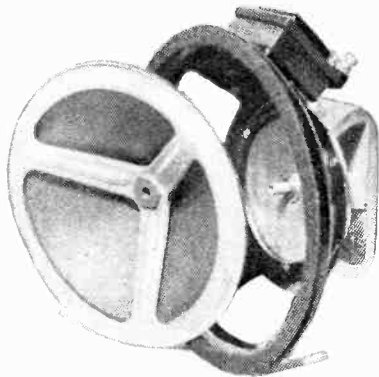

The new Alpha speaker with special cone centring, designed by R. & A.

independent of the outside frame of the unit and is attached to a pressed steel member with three radial arms fitting inside the

angle of the cone. This member is accurately located by a shoulder on the centre pole of the magnet, and is held by a single bolt. There can be no doubt that this design marks a distinct advance in the reliability of moving-coil units, for considerable damage would have to be sustained by the outer shell before the diaphragm was damaged. Further, it is possible to remove and replace the diaphragm for inspection without fear of upsetting the alignment. The list price of this unit is 52s. 6d.

The well-known "Bantam," "Challenger," and "Victor" permanent magnet units are now supplied with alternative output transformers covering all types of output stage in current use, and an improved differential armature moving iron loud speaker unit (Type 60), with larger magnets and a 12in. diaphragm, has been introduced at 21s.

Reproducers and Amplifiers, Ltd., Frederick Street, Wolverhampton.

R.C. & WILSON ELECTRIC.

Aerial equipment, both outdoor and indoor, provided the main display at this stand.

Self-feeding soldering iron, hand microphone and transformer, by R. C. & Wilson.

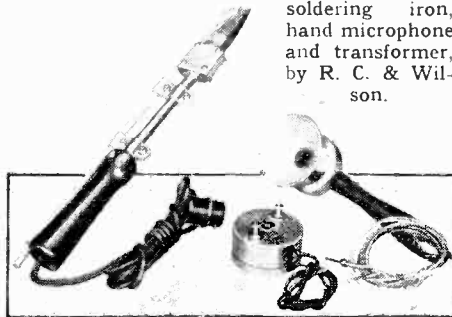

A hand-type microphone at 7s. 6d., and various other accessories, including a self-feeding electric soldering iron, attracted attention.

R.C. and Wilson Electric, Ltd., 51, Whitcombe Street, W.C.2.

R.G.D.

A reputation second to none for high-quality radio-gramophones in which nothing has been sacrificed to considerations of cost

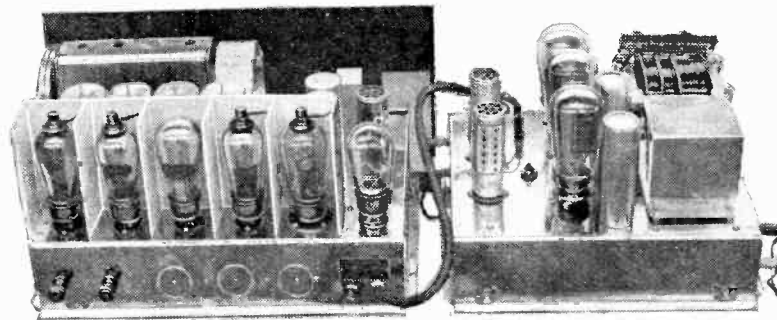

Noise-suppressor relay of the R.G.D. Model 1201.

Chassis and power unit of the R.G.D. Model 1201 radio-gramophone.

has now been firmly established by the R.G.D. concern. Their productions are not cheap, but one feels that they include every known refinement and development in technique that is likely to contribute anything towards the ultimate goal of perfect reception.

This year's leading model, Type 1201, includes eleven valves and a rectifier, and is fitted with delayed amplified A.V.C., a noise suppressor, and a tuning indicator. Dual loud speakers, specially made by B.T.H., are installed.

Space does not permit of a complete description of the circuit, but it may be

stated that it comprises a signal-frequency H.F. stage, with three signal-frequency tuned circuits. A two-valve frequency-changer is employed, followed by one I.F.

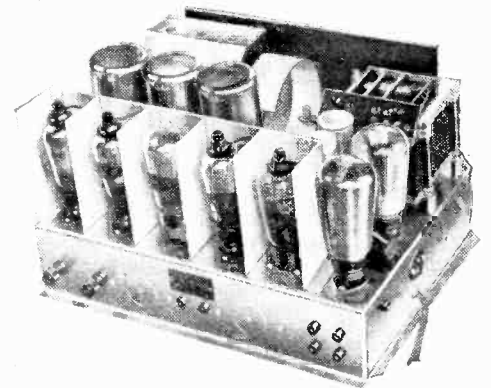

R.G.D. Model 702 radio-gramophone chassis.

amplifier and a double-diode-triode second detector. The "triode" part of this valve does not handle the signal, but serves purely as a D.C. amplifier for the A.V.C. system.

Next comes what is probably the most interesting part of the set—the "paraphase" resistance-coupled L.F. amplifier, which may fairly be expected to provide the most perfect amplification possible. The phasing arrangement is unusual, the necessary feed-back voltage being picked off a tapped grid leak. The push-pull output valves are triodes, giving 6 watts.

Noise suppression is effected mechanically through a relay, operated by an extra valve, and comes into operation when the noise level reaches a certain value. In its simplest form, without automatic record changing, the price is 86 guineas.

A rather less ambitious, but still very in-

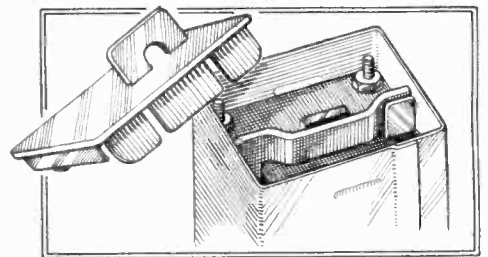

teresting, set is the Model 702, another superheterodyne with H.F. stage, delayed A.V.C., and a resistance-coupled 3-watt output stage fed direct from the anode of a double-diode-triode valve. The same dual B.T.H. speakers are fitted, as well as a tuning indicator.

Radio Gramophone Development Co., Ltd., 18-20, Frederick Street, Birmingham.

R.I.

The Madrigal Superhet Radio Gramophone is the premier set of the new season's models. It is a six-valve receiver with one

Olympia's Story—

valve acting as mains rectifier, the remaining five being arranged as first detector, oscillator, I.F. amplifier, second detector, and output. Band-pass tuning is employed for the aerial circuit and also for the I.F. coupling. A feature of the circuit is the inclusion of amplified A.V.C. working on the I.F. stage, this valve, incidentally, being a variable- μ pentode. There is a control located on the motor board, which serves as an adjustment for background level, being, in effect, a gain control of the I.F. amplifier.

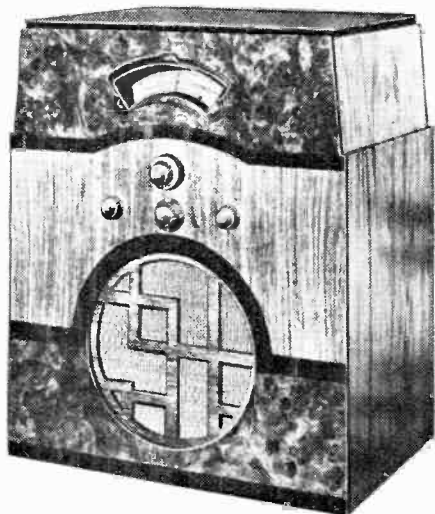

R.I. Madrigal Class "B" four-valve receiver.

The volume control is incorporated in the L.F. stage, and is effective on both radio and gramophone. A B.T.-H. Junior R.K. moving-coil loud speaker is housed in the lower part of the cabinet, and the price is £38.

The specification of the Madrigal Class "B" four-valve receiver is particularly attractive, for it incorporates the new Micrion iron-cored coils. One H.F. stage is employed, also a moving-coil loud speaker, and the price is 15 guineas.

The third new model is a three-valve H.F.-det.-pentode A.C. mains receiver at 15 guineas. Here, again, Micrion coils are employed. The design of the electrical equipment is not the only attractive feature of the new R.I. sets, for the cabinet work is particularly pleasing both from the point of view of finish and design.

New components were well in evidence this year; they include mains transformers for the Westinghouse rectifiers, some new

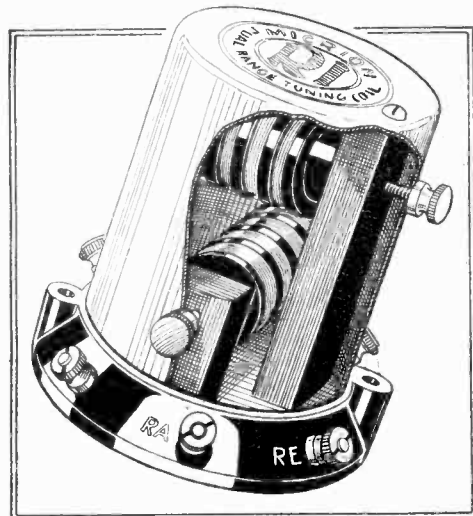

Details of R.I. Micrion coil.

L.F. chokes, Class "B" driver transformers and output chokes, and an Auto-Parafed L.F. transformer for auto-transformer connection only. It has a primary inductance of 84 henrys, gives a voltage step-up of one-to-four, and costs 6s. 9d.

The Micrion coil was shown; its particular feature, other than the inclusion of the new style of core, is that provision is made for permeability adjustment of inductance on both wavebands. The coil costs 12s. 6d.

Radio Instruments, Ltd., Purley Way, Croydon, Surrey.

RADIALADDIN.

This firm were showing a three-valve A.C. receiver with band-pass tuning, pentode output, and moving-coil loud speaker in a consolette cabinet. They offer "new sets for old," accepting used sets as part payment for new. Particulars of the Radialaddin Club were available.

Radialaddin, Ltd., 46, Brewer Street, W.1.

RADIOLAB MFG. CO.

The Radiolab Complete Valve and Set Tester formed the sole exhibit on this stand. It is a self-contained portable instrument for testing and overhauling a wireless

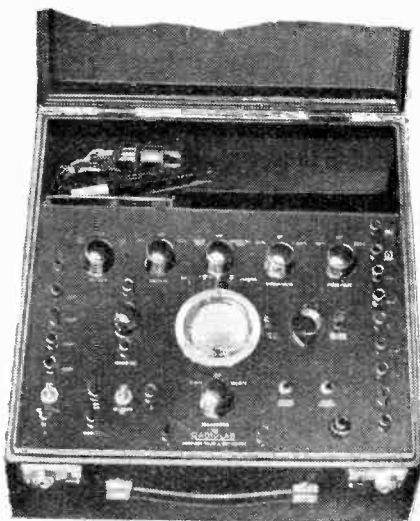

Radiolab complete valve and set tester.

receiver with provision for measuring all the voltages and currents taken by the valves under working conditions. A most comprehensive test set costing but £12 12s.

Radiolab Mfg. Co., Sandridge Works, St. Albans.

RAWLPLUG.

The stand of this firm was devoted to accessories which have various applications in the construction and installation of wireless receivers. Durofix is a particularly useful adhesive material, and Rawlplug Plastic Wood is used in cabinet-making and for repair work. There was an ingenious little staple fixer, especially useful when installing loud-speaker extensions.

Rawlplug Co., Ltd., Rawlplug House, Cromwell Road, S.W.7.

REDFERN.

"Two-side" radio panels, with a mahogany surface in front, and black on the reverse side, have recently been introduced. Ribbed coil formers in a number of different sections from 1in. up to 4in. in diameter were shown, together with ebonite tube and rod and various ebonite mouldings, as well

as lead-in tubes and ribbed and perforated separators for accumulators.

Redfern's Rubber Works, Ltd., Hyde, Cheshire.

REGENTONE.

On this stand the Quadradyne Band-Pass Four occupied a prominent position. This is a three-valve set with a variable- μ H.F. pentode in the H.F. stage, a triode detector, and a pentode output valve; a metal rectifier is used for the H.T. supply. It is priced at 10 guineas. The Quadradyne Five is a similar receiver at £12 17s. 6d., but includes two H.F. stages. A battery set is available with a Class "B" output stage at 11 guineas.

The Regentone Superhet includes a detector-oscillator, a variable- μ I.F. stage, triode second detector, and pentode output valve; it is listed at 14 guineas. A full vision calibrated tuning scale is fitted, and there is a tone control.

In addition to receivers, a range of H.T. eliminators completed the exhibit.

Regentone, Ltd., 21, Bartlett's Buildings, Holborn Circus, E.C.4.

RIST.

This exhibit consisted of a most comprehensive range of instrument wires, battery cables, aerial and connecting wires of all descriptions, together with a wide selection of bakelite parts, these being of interest mainly to the trade.

A. Rist (1927), Ltd., Waveney Works, Freemantle Road, Lowestoft.

ROLA.

British Rola maintain this year their high standard and offer a wide choice of speakers, both energised and permanent magnet types. The cone diameters of their standard models are 6in., 7 $\frac{3}{4}$ in., and 9in., with choice of field resistances. All models are available with universal transformers suitable for pentode or power valves. When ordering for Class "B" output stages, the type number of the valve to be used should be given.

Dual balanced pairs of speakers are available in both energised and permanent magnet types.

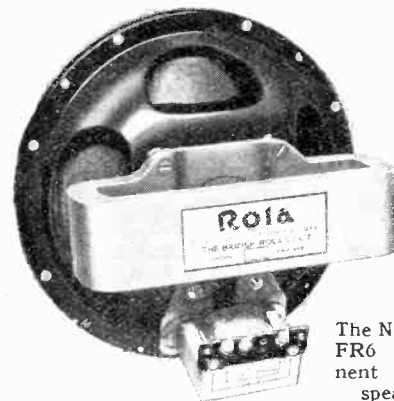

The New Rola FR6 permanent magnet speaker.

A new product is a Class "B" speaker amplifier unit which comprises a P.M. speaker in association with a properly matched "B" amplifier stage. Adequate literature is available, giving full instructions for connections of all types of speaker.

British Rola Co., Ltd., Minerva Road, Park Royal, N.W.10.

RONNIE ENGINEERING.

The Ronnie earth tube is solidly constructed of heavy-gauge copper and gun-

Olympia's Story—

metal; its principal feature is that it is packed with a mineral compound—actually an acid-free preparation of copper sulphate—which is highly deliquescent and hydroscopic, and is intended to improve the conductivity of the earth connection. The compound is available separately.

Ronnie Engineering, Crewdson Road, S.W.9.

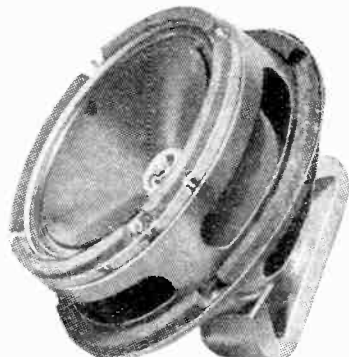

A Sinclair double speaker of unusual construction.

SEABROOK BATTERIES.

A battery display by this firm included high tension and grid bias types.

Seabrook Batteries, Ltd., 205, Bedford Avenue, Trading Estate, Slough, Bucks.

SHALLESS & EVANS.

The range of Shalless receivers included some ten different models, the majority being battery operated. Of special interest was the Shalless Coliseum model utilising a four-valve circuit with one H.F. stage and including Class "B" output. Entirely self-contained and embodying a P.M. moving-coil loud speaker it costs but 9 guineas. A two-valve A.C. mains receiver is available at the same price.

Shalless and Evans, Tranquil House, Tranquil Vale, Blackheath, S.E.3.

SHAWNDEL TOOL CO.

Mainly of interest to manufacturers. The device shown is an ingeniously devised holder for bobbins of wire which provides a free feed, but avoids the risk of breakage through overrun, and ensures that the wire is kept taut, but without undue strain, while winding operations are being carried out.

Shawndel Tool Co., 99, Regent Street, W.1.

SIEMENS.

The principal exhibit was the well-known "Full o' Power" series of H.T. batteries which are made in four types, the "Cadet," "Standard," "Power," and "Super Radio." Useful hints are given in a new booklet dealing with battery design in relation to Class "B" amplification, and a new "double capacity" 120-volt unit (No. 1168), has been introduced for that purpose.

Siemens Electric Lamps and Supplies, Ltd., 39, Upper Thames Street, E.C.4.

SIMPSON'S ELECTRICAL.

The Simpson's Electrical turntable was to be found on this stand, and also a converter unit for working the synchronous motor from D.C. mains supplies.

Simpson's Electricals, Ltd., Grange Road, Leyton, E.10.

SINCLAIR.

The outstanding exhibit here was a dual moving-coil speaker of unusual construction.

One speaker has a 9in. cone and is suitable for reproduction of low notes, and the other a 7in. cone giving good high note response. The 7in. speaker is accommodated within the larger cone, a specially shaped magnet being used for the purpose.

In addition, a range of speakers of more usual design was also shown.

Sinclair Speakers, 49-50, Twyford Street, N.1.

SIX-SIXTY.

Two receivers were shown by the Six-Sixty Radio Company this year. One, the Super-Five, is an A.C. mains four-stage receiver embodying two H.F. stages and a super power pentode. There are three controls only, the mains switch and volume adjustment being ganged, the others being wave change and tuning. The scale is wavelength calibrated and the price is 11 guineas. A moving-coil loud speaker is included. The other model is last season's three-valve battery set, which at 10 guineas now includes the batteries.

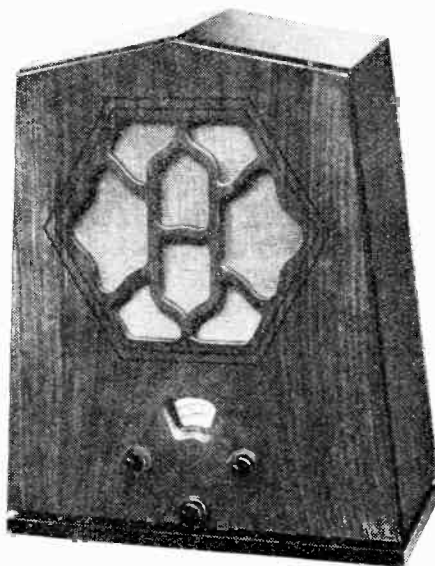

Six-Sixty new Super-Five receiver.

Of the new Six-Sixty valves shown, one was a Class "B," the 220B at 14s. and rated at 1½ watts output; another a I.H. rectifier, I.H.60/250, at 12s. 6d.; and there was also a new indirectly heated H.F. pentode at 17s. 6d.

Six-Sixty Radio Co., Ltd., 17-18, Rathbone Place, W.1.

SLEKTUN.

The chief interest on this stand centred around two new "R. & R." receivers; one was an A.C. mains set with detector and

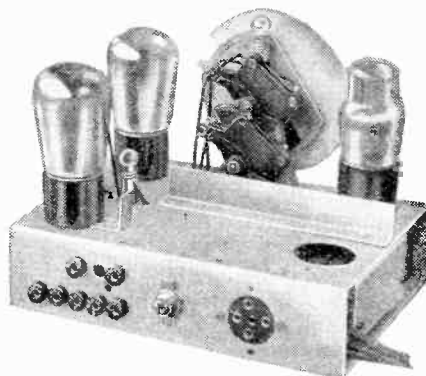

Chassis of the Slektun Class "B" Three.

pentode stages for local reception, selling at 9 guineas, and the other, a Class "B" battery set of similar type, at 8 guineas.

Amongst other exhibits, two recent products were a new design in band-pass tuning coils and Class "B" transformers.

Slektun Products, Winder House, Douglas Street, S.W.1.

SONOCHORDE.

Amongst a large variety of speakers here, the outstanding attraction seemed to be those of very small dimensions. One was a

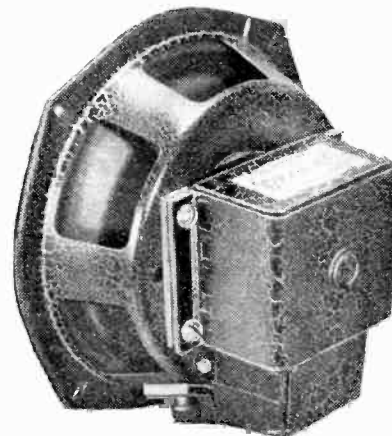

The Sonochorde de Luxe moving-coil speaker.

Midget P.M. speaker with a 5-inch diameter cone, and the other, an energised type of the same dimensions, having a 2,500 ohms field resistance. These speakers have been specially designed to meet any demand for midget, portable, and car sets. From the point of view of quality of reproduction, the de Luxe models of larger dimensions are naturally to be preferred, and here there is a wide range of outstandingly good Sonochorde speakers to choose from, both in energised and permanent magnet types.

Sonochorde Reproducers, Ltd., 1, Willesden Lane, N.W.6.

SOUND SALES.

A permanent-magnet moving-coil speaker with a vellum cone was to be found on this

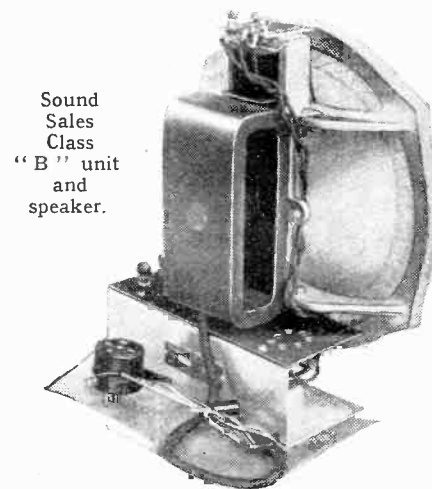

Sound Sales Class "B" unit and speaker.

stand at the price of 40s., with a universal transformer, and the same speaker is obtainable built into a Class "B" unit at the price of £3 7s. 6d. complete with tone and volume controls. A very wide range of mains and Class "B" transformers and smoothing chokes was also on view. A completely shrouded and specially ventilated mains transformer for *The Wireless World* New Monodial Super is available at £3, and a

Olympia's Story—

30H. 1,250 ohms speaker field replacement choke for this set was also shown at 25s.

Sound Sales, Ltd., Tremlett Grove, Junction Road, N.19.

SMITH'S.

Anodex H.T. batteries of which a specimen recently survived a "Wireless World" laboratory test with flying colours, were prominently exhibited. Batteries of all usual voltages, in standard, double, and triple capacity are produced, together with special assemblies for Q.P.P. and Class "B" sets.

Low-tension cells, both of the mass type and multiple-plate type, were shown in all capacities, together with jelly-acid cells for portables and H.T. accumulator batteries.

S. Smith and Sons (Motor Accessories), Ltd., Cricklewood Works, N.W.2.

SOVEREIGN.

The most interesting component on this stand was the new permeability tuner. It is an extremely compact unit and yet covers the tuning range of medium (200-550 metres) and long waves (1,000-2,000 metres) without the usual condenser.

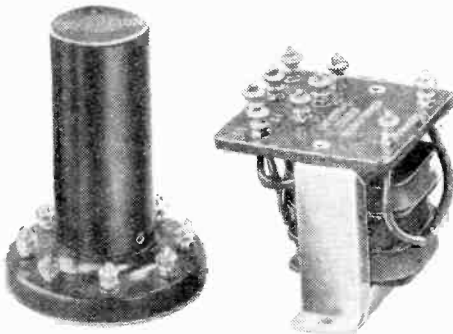

The Sovereign iron-cored coil unit and driver transformer.

Other items of interest were a good range of D.C. and A.C. eliminators at very low prices; a new volume control in values from 10,000 ohms to 2 megohms at the price of 2s. 9d., and Class "B" driver transformers and output chokes.

Sovereign Products, Ltd., 52, Rosebery Avenue, E.C.1.

STANDARD TELEPHONES & CABLES.

The Standard 40 superheterodyne shown on this stand has only three receiving valves, but is rated to give an output of 2½ watts; it is priced at £11 17s. 6d. The Standard 60 is a larger model at £15 17s. 6d., with a detector-oscillator, an I.F. stage, a diode-triode second detector providing A.V.C., and a pentode output valve.

In addition to the superheterodynes, a number of small straight sets was shown. The Standard 30B is of the battery type

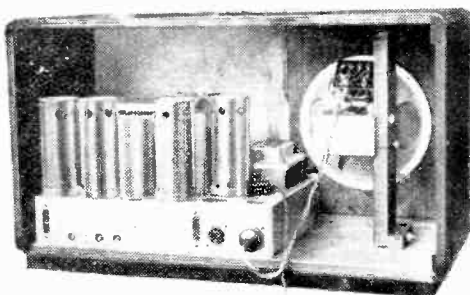

Standard Telephones "Standard 60" superheterodyne.

with an H.F. stage and an output pentode, and it is priced at £5 12s. 6d., including valves and batteries. Two-valve receivers are available for batteries, A.C. or D.C.

The range of Micromesh valves has been greatly extended, and now includes a large number of battery types. In the A.C. models the H.L.A.1 triode has a resistance of 10,000 ohms, with an amplification factor of 80, while there is a power triode, rated for an output of 1¼ watts at 200 volts, which possesses a mutual conductance of 12 mA/V.

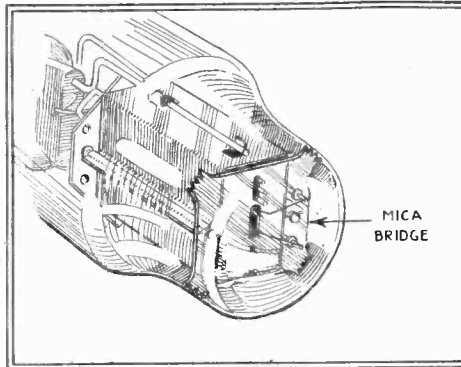

Standard Telephones Micromesh battery pentode, type B.1.

Screened H.F. pentodes are made in the ordinary and variable- μ types, the latter having a grid base of about 40 volts, and rated for 250 volts anode and 100 volts screen potentials. The 11.A2 valve is a diode-triode, the triode portion having a resistance of 18,000 ohms with an amplification factor of 50. Pentodes of both the directly and the indirectly heated types are to be found with outputs in the neighbourhood of 3 watts. H.T. rectifiers complete the range of valves proper, but there is also a tuning indicator for A.V.C. sets which works on the cathode ray principle.

The radio service set tester and associated equipment, recently described in this journal, was also exhibited.

Standard Telephones and Cables, Ltd., Connaught House, Aldwych, W.C.2.

SUNBEAM.

Universal sets, designed for use interchangeably on A.C. or D.C. mains without

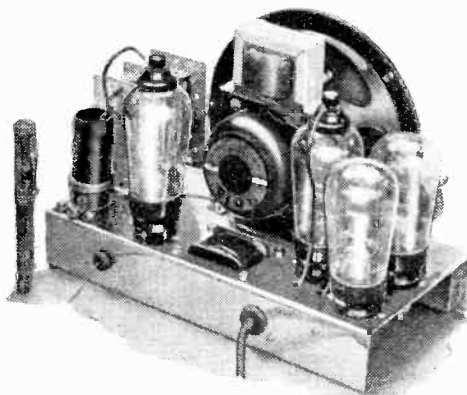

Chassis of a Sunbeam Midget, compared with a fountain pen.

any alteration, comprised the main exhibits of this firm. The "universal" principle is employed in the Midget set type M30, which includes an H.F.-det.-L.F. arrangement with valve rectification, and two tuned circuits.

Although this set is extraordinarily compact, it is slightly larger than the American midgets and includes a bigger loud speaker (of the moving-coil type with a 5½-inch

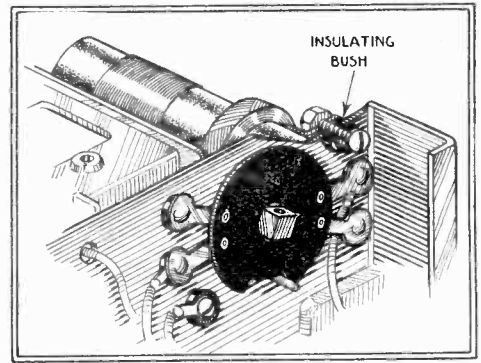

The Sunbeam Midget: space is saved by using holding-down screws as electrical connections.

cone) than those found in American sets. Accordingly, it may fairly be expected that quality will be considerably better.

In the model M34 the midget chassis is employed but, due to the somewhat larger size of the cabinet, a full-size Magnavox loud speaker can be fitted. Both these sets, and indeed all the "universal" Sunbeam models, employ a special type of power rectifier which is stated to withstand continuously a pressure of 300 volts between cathode and heater.

In the larger Universal sets, which are in every way comparable with ordinary A.C. or D.C. receivers, grid detection is employed. The loud speakers are of the energised type and connected in parallel with the output from the rectifier.

Sunbeam Electric, Ltd., Sunbeam Road, North Acton, N.W.10.

SWIFT LEVICK.

This firm, specialising in permanent magnets, is meeting every demand of the manufacturer for all types and sizes of magnet, even down to the midgets, and some very attractive and efficient models were on view.

Swift Levick and Sons, Ltd., Clarence Steel Works, Sheffield.

T.C.C.

An entirely new product of this firm is the Condenser Anti-Interference Unit. It consists of two 1,500-volt test condensers rated for continuous working at 450 volt D.C. or 250 volts A.C. and is housed in a neat bakelite case fitted with a twin fuse holder and an earth terminal. The unit costs 9s. 6d. and is for use in suppressing interference brought in by the supply mains or, if the trouble is caused by small motors, a device of this nature will often effect a cure.

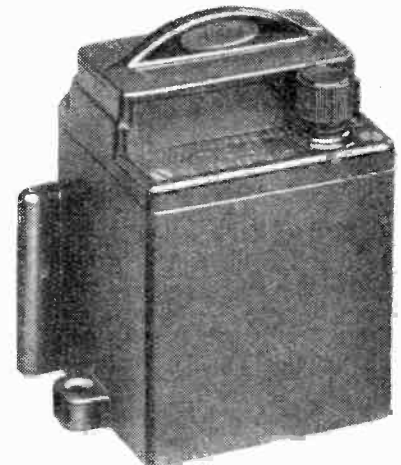

T.C.C. Condenser Anti-Interference Unit.

Olympia's Story—

The range of T.C.C. condensers so adequately meets the requirements of set builders that there have been few changes this year and their programme for the coming season remains substantially the same as hitherto. A few miscellaneous models have been added, however, the principal new items comprising a limited range of small tubular dry electrolytics with wire ends for suspending in the wiring. A size that is useful for grid circuit decoupling is the 25 volts 25 mfd. model.

Telegraph Condenser Co., Ltd., Wales Farm Road, N. Acton, W.3.

TANNOY.

Public address equipment formed the principal exhibits of this firm, and many large amplifiers and horn-type projection speakers were shown. A heavy duty moving-coil speaker rated to handle 30 watts is also listed, with various types of microphone.

The Superheterodyne Radiogramophone de Luxe was shown, and this is built in two chassis. One contains the seven-valve superheterodyne with its own mains equipment, and the output of this is arranged to have an impedance of 600 ohms for matching to any standard large power amplifier. Any of the amplifier types exhibited may be used with it, since these all have their own mains

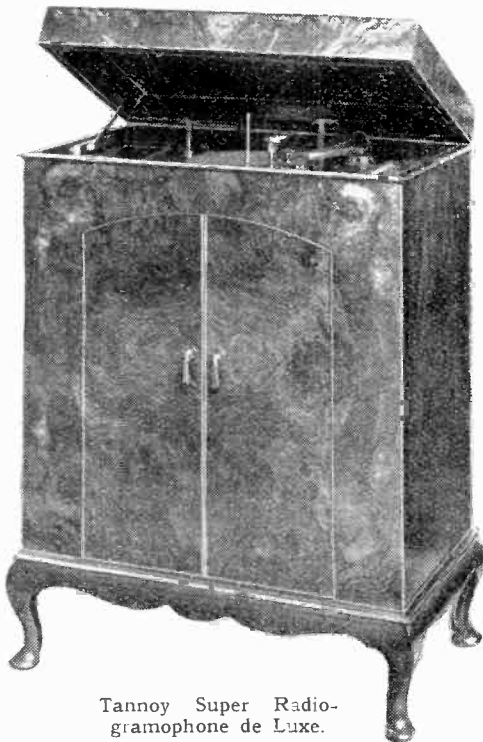

Tannoy Super Radio-gramophone de Luxe.

equipment and are arranged to work with an input impedance of 600 ohms. An unusual feature of the superheterodyne is that an H.F. pentode is used for the oscillator valve, and it is claimed that this leads to increased frequency stability.

Tannoy Products, Canterbury Grove, W. Norwood, S.E.27.

TELEGRAPH CONSTRUCTION AND MAINTENANCE CO.

This firm displayed nickel iron alloys in various forms for cores where high permeability is needed. "Calomic" resistance wire was also shown and various forms of jointing material.

Telegraph Construction and Maintenance Co., Ltd., Enderley's Wharf, Greenwich, S.E.10.

TELEPHONE MFG. CO.

British made Hydra condensers varying in size from 0.1 mfd. to 10 mfd. and for working voltages of from 250 to 750 volts D.C. formed the chief exhibit of this firm. Prices range from 1s. 6d. to 26s.

Telephone Mfg. Co., Ltd., Hollingsworth Works, W. Dulwich, S.E.21.

TELSEN.

Among the many innovations for the present season is a new iron-cored tuning-coil assembly of unusual compactness, with an open-ended core. With an inductance

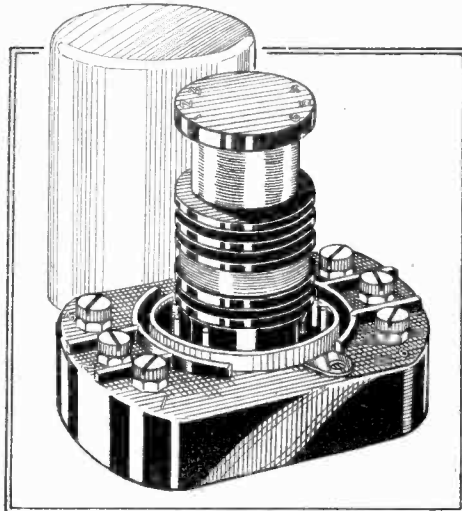

Telsen iron-cored tuning coil.

of 156 microhenrys, this coil is stated to have an efficiency at least 50 per cent. greater than that of normal air-cored types, and all are matched to a common standard. This is a general-purpose coil, comprising primary, secondary, and reaction windings, and is sold at 8s. 6d. Telsen band-pass I.F. transformers, with variable coupling and individual tuning, as used in the New Monodial, now cost only 7s. 6d. each.

A particularly workmanlike mains transformer for "A" class rectifiers, with a 4-volt L.T. winding and a protective bakelite cover over the terminals, costs 32s. 6d. The new low-voltage dry electrolytic condensers, of 25 and 50 mfd. capacity, are made in particularly compact tubular form for suspending in the wiring, and will be useful for by-pass purposes in grid bias circuits. High-voltage electrolytic condensers have also been introduced.

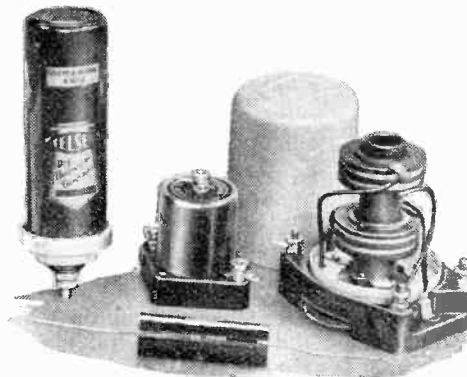

Telsen dry electrolytic condensers, new screened H.F. choke and I.F. transformer.

The series of Telsen L.F. transformers have now been brought up to date by the addition of special Class "B" components, and screened H.F. chokes are produced.

Iron-cored tuning coils are included in the latest H.F.-det.-L.F. Telsen A.C. set, and also in the Class "B" 4-valve kit, which is sold for £3 17s. 6d. complete except for cabinet and speaker. The "Air Marshal" det.-2 L.F. set is sold in completed form, with valves, batteries, and moving-coil loud speaker, for 5 guineas.

Telsen Electric Co., Ltd., Aston, Birmingham.

362 VALVES.

A new range of battery and A.C. valves were displayed here, but probably the principal interest was in the "Toledo" type of metal cased valve, of which an illustration was included in our issue of last week. A special display was made of Class "B" valves and Class "B" components.

The 362 Radio Valve Co., Ltd., 415, Mare Street, Hackney, E.8.

ULTRA.

The Tiger superheterodyne was prominently displayed on this stand; it is available for A.C. or D.C. operation, and is priced at 14 guineas as a table model and 17 guineas as a consolette. The valves are arranged as a detector-oscillator, variable-mu I.F. stage, screen grid second detector, and a 2½ watts pentode output stage. The battery model is similar, but is fitted with a Class "B" output stage.

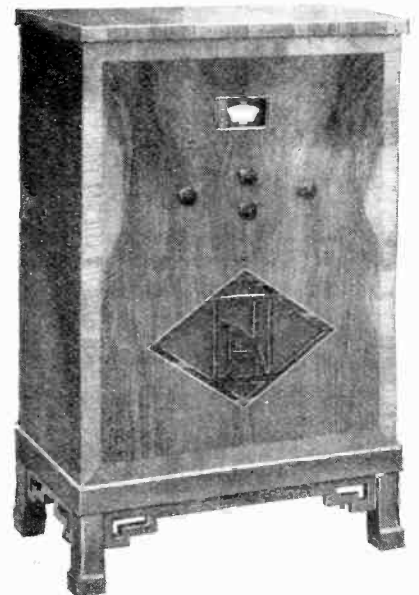

The Ultra Electric "Tiger" superheterodyne, consolette model.

The Panther superheterodyne is a larger receiver with a two-valve frequency changer and two I.F. stages; there is a duo-diode second detector, and the set is listed at 19 guineas as a table model. It is for A.C. operation.

The Lynx models are for A.C. or D.C., and have a variable-mu H.F. stage with a screen grid detector, and a pentode output valve. The price is 10 guineas. This receiver is also available in radio-gramophone form at 18 guineas.

Ultra Electric, Ltd., Erskine Road, N.W.3.

UNIVOLT.

The well-known Univolt Radiogram unit with A.C. motor, pick-up, and volume control, has been reduced in price from 5½

Olympia's Story—

guineas to 85s. An indoor aerial, known as the "Het," was also on show at this stand.

Univolt Electric, Ltd., 119, Finsbury Pavement, E.C.2.

UTILITY.

A new die cast gang condenser was a feature at this stand. This component has the advantage of being extremely compact and is, therefore, ideal for use in small or even midget types of sets. The rigid construction is claimed to ensure constancy of matching. Screened trimmers of adequate capacity value are fitted and can be adjusted from above. The condenser has a low minimum capacity.

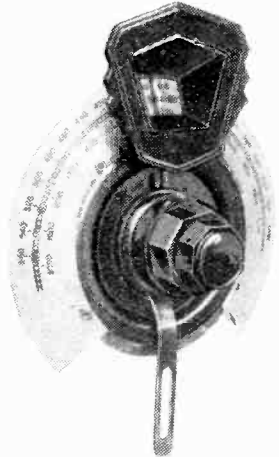

A new Utility tuning dial of slow motion type, known as the "Micro Disc."



Varley Nicore I.F. transformer with external coupling adjustment.

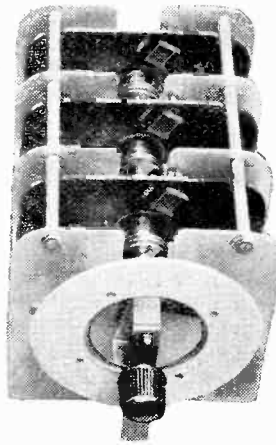

Varley Permeability Tuner.

W.B.

The majority of the well-known W.B. loud speaker units were shown in redesigned form, with aluminium bases, and in nearly every case the new W.B. "Micro-lode" feature was included. This is a switching arrangement incorporating two independent contact arms by means of which the output transformer ratio can be accurately adjusted to match the loud speaker load to the output stage. Seventeen ratios are thus available for single output valves and four ranges for push-pull, Q.P.P., or Class "B" output stages.

An addition to the series of permanent magnet units has been made in the new PM6, which is a soundly made "junior" model with 6 1/2 in. cone and the "Mansfield" type of magnet.

A new permanent magnet speaker, the P.M.6 by W.B.

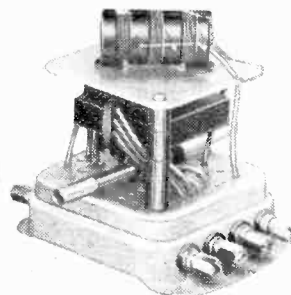
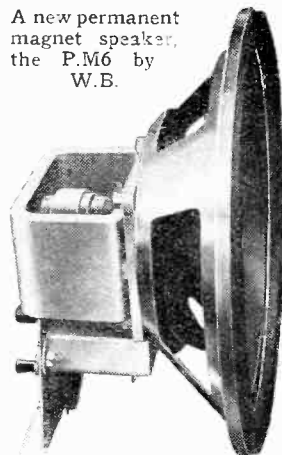

Wearite Nucleon iron-cored coil, Senior type, and iron-cored I.F. transformer.

New cabinets of attractive modern design have been developed, the PM1A, PM2A, PM4A, and PM6 units.

Among components, valve holders of the latest types and Class "B" amplifiers for heavy duty were given prominence.

Whiteley Electrical Radio Co., Ltd., Victoria Street, Mansfield, Notts.

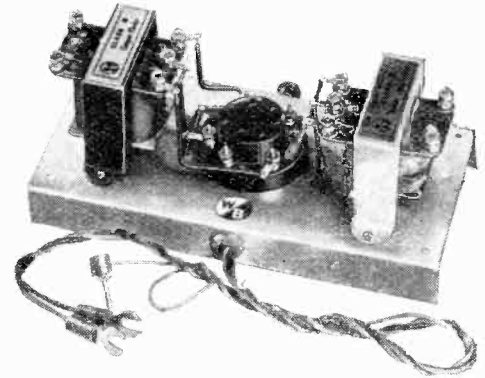

W.B. standard Class "B" unit.

WEARITE.

Nucleon iron-core tuning coils provided the principal exhibit on this stand. They are available in a wide variety of types, and in "Senior" and "Junior" models with built-in waveband switching. An iron-core type I.F. transformer was also being shown, and this component is provided with external adjustments for the trimming and the coil coupling.

Air-core coils and I.F. transformers are also listed, and the exhibit included Class "B" transformers, mains transformers, smoothing chokes, switches, and volume controls. H.F. chokes were to be found in both air- and iron-core types in addition to low-resistance high-current carrying capacity H.F. chokes for use in the mains circuits.

Heterodyne whistle filters of various types were exhibited, including a special model for *The Wireless World* New Monodial Super with a very sharp cut-off, listed at 15s., and there was an A.V.C. unit incorporating a Westector at 10s. 6d.

Wright and Weaire, Ltd., 740, High Road, Tottenham, N.17.

WESTINGHOUSE.

Two new models have been added to the Westinghouse range of H.T. metal rectifiers. One, the H.T.12, replaces the styles H.T.6 and H.T.7, its output being 200 volts at 30 mA. The other, styled the H.T.13, has particularly good regulation, having been developed especially for use with Q.P.P. and Class "B" amplifiers. The price is 17s. 6d. in each case.

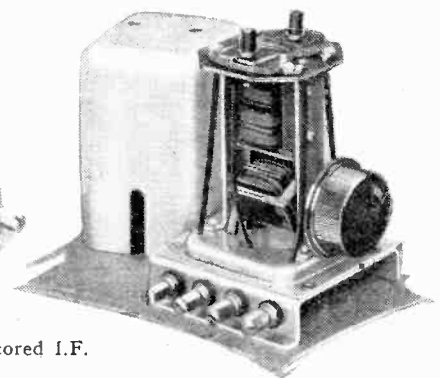

Utility also have a useful selection of tuning dials, including a new slow motion type, the "micro disc." There is also a neat horizontal scale dial. All dials can be illuminated.

Switches and a large range of bakelite knobs were other features of this exhibit.

Wilkins and Wright, Ltd., Holyhead Road, Birmingham.

VULCO DRY BATTERIES.

The exhibit of this firm was confined exclusively to dry batteries, including those sold under the Vulco and Stag trade names. Batteries of the "standard" and "power" capacities are produced.

Vulco Dry Batteries Co., Ltd., Vulco Works, N.19.

VARLEY.

Nicore tuning coils of various types occupied a prominent position on the Varley stand; in addition to a complete range of signal frequency and oscillator coils, Nicore I.F. transformers with external adjustments for trimming and coil coupling were shown. A wide range of push-pull, ordinary, and Class "B" transformers was on view, and the L.F. couplings have been extended by the addition of a resistance-capacity compensating unit giving a rising characteristic to correct for sideband cutting. This component is priced at 11s. 6d. An automatic volume control unit employing a Westector was shown at 15s. 6d. A new departure in tuning was to be found in the Permeability Tuner, a three-gang unit in which tuning is carried out by varying the iron cores of the coils.

Several superheterodynes were shown, including a four-valve model without an I.F. amplifier, and a five-valve set with A.V.C. This latter set is priced at 18 guineas as a

Of special interest, however, was the range of Westectors, the new metal oxide diode detectors which are available as half-

Olympia's Story—

wave or full-wave types, the latter being comparable with a duo-diode detector.

A complete range of single- and multi-circuit battery chargers was also shown, the last-mentioned type being of interest mainly to the service engineer. Prices of many of the models have been reduced.

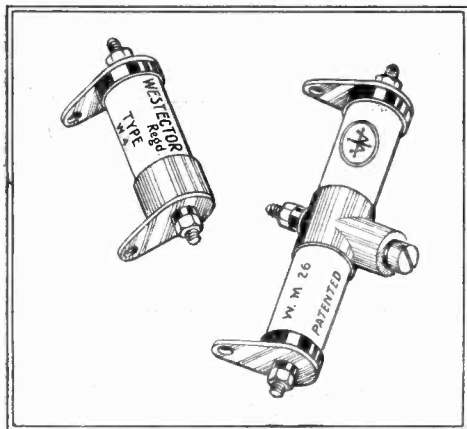

Half-wave and full-wave Westectors.

A special feature was made of battery and A.C. mains superheterodyne receivers designed by the company's engineers and for which constructional details are available. They embody the new Westector and exemplify modern practice, for the latest developments, such as A.V.C. and battery economising arrangements using Westectors, are incorporated.

Westinghouse Brake and Saxby Signal Co., Ltd., 82, York Road, King's Cross, N.1.

A New Book

One Thousand Questions and Answers on Company Law (Revised and Enlarged Edition), by H. A. Ashton. The questions and answers, which cover almost all legal points likely to occur in the formation and working of public or private companies, have been compiled from the works of a considerable number of recognised authorities, statutes and judgments. In addition to these questions and answers and their classified index, the book gives a useful glossary of the legal words and phrases used in company law and a list of duties and fees payable on registration of private limited companies. Pp. 291 + xix. Published by The Company Law Press, Ltd., London. Price 5s.

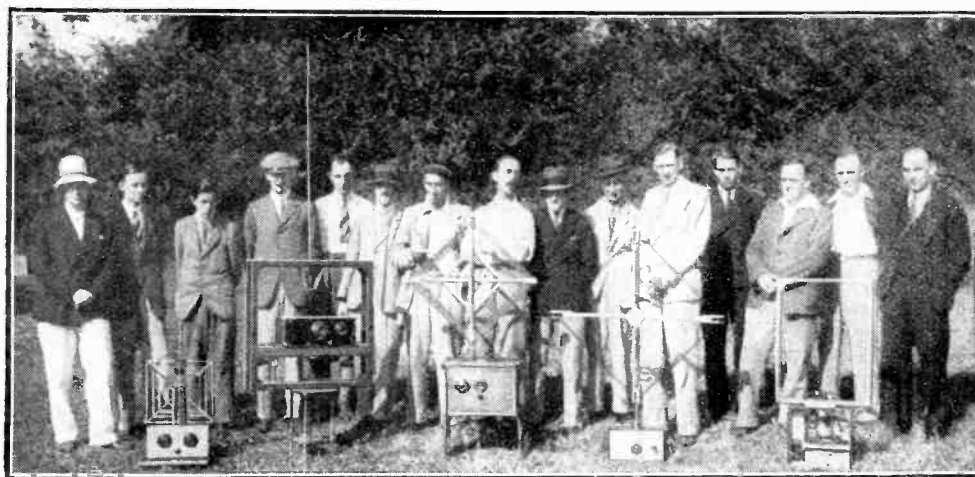

DIRECTION FINDERS "ON PARADE." Some of the winning groups at the conclusion of the recent transmitter hunt organised by the Golders Green & Hendon Radio Society. The first prize was won by Mr. Child's group with a receiver, second from left, using a special compensating aerial.

DISTANT RECEPTION NOTES

New High-powered Transmitters

THE outstanding feature of long-distance reception at the moment is the number of medium-wave stations that are receivable in broad daylight. Unless conditions are particularly unfavourable the two Brussels stations, Langenberg, Rome, Leipzig, the Poste Parisien, Hilversum, and Fécamp are nearly always to be heard when they are working, and other stations that can frequently be picked up are Beromunster, Strasbourg, Breslau and Trieste.

Comparatively few of the new high-powered transmitters that were due to come into operation in the course of the present summer are yet at work, but many should be heard within the next few weeks. Listeners may have noticed that the two Brussels stations are coming in more strongly than they were, and I understand that there has been an increase in the power of the present transmitters, though the new 75-kilowatt plants are not yet ready.

Work on the Witzleben high-powered transmitter is being pressed forward at top speed and this station should make its bow in the early days of the autumn. Tests already appear to be taking place, for I have received the Berlin programmes at far more than normal volume on 419.5 metres.

Wavelength Variations

Kaunas has altered its wavelength a little and is no longer seriously interfering with Huizen. For some days prior to the writing of these notes Monte Ceneri has also been working on a slightly different wavelength, with the happy result that Kalundborg is coming through with great volume and excellent quality. This is the first time that one has had a real chance of seeing what Kalundborg's 60-kilowatt transmitter can do. It is not, by the way, working at full power, for the authorities have decided to use no more than is required to provide an adequate programme service in their own country.

Toulouse Midi seems quite happy with its mere 8 kilowatts, and I hear that the service area of the station is considerably greater than that of the old transmitter. In this country the volume is certainly greater now

than it was when the old transmitter was at work with the same output rating.

Budapest is another station that is now heard at greatly increased volume. For a good many weeks just after midsummer it was almost impossible to receive, but now it can be heard well night after night. I

FOREIGN BROADCAST GUIDE

OSLO (Norway).

Geographical position : 49° 52' N. ; 10° 49' E. Approximate air line from London : 712 miles. Wavelength : 1,083 m. Frequency : 277 kc/s. Power : 60 kW. Standard time : Central European (coincides with B.S.T.).

Standard Daily Transmissions.

10.30, B.S.T., foreign news; 10.50, carillon, sacred service (Sun.); 11.15 (weekdays); 12.55, time signal (Nauen), gramophone records, weather, etc.; 17.00, concert, talks; 19.30, main evening entertainment; 22.00, weather, news; topical talks; 22.30, dance music or light concert.

Announcer : Man.

Call : *Hallo, Oslo!*

Opening and closing signals as under :—



Interval signal : Abbreviated theme from Grieg's opera, *Sigurd Jorsalfar* (six notes)



Closes down with the words : *Hallo, Oslo! Hermed er programmet slut for idag* (with this our to-day's programme ends) *god natt, god natt.*

Relays : Kristiansand, 235.5 m. (1,274 kc/s.), 0.5 kW.; Stavanger, 240.6 m. (1,247 kc/s.), 0.5 kW.; Bergen (occasionally) 264.1 m. (824 kc/s.), 1.0 kw.; Fredriksstad, 367 m. (817.4 kc/s.), 0.7 kW.; Rjukan (0.15 kW.), Aalesund (0.35 kW.) and Notodden (0.08 kW.), 447.1 m. (671 kc/s.); Porsgrund (0.7 kW.), Tromsø (0.1 kW.), Bodo (0.5 kW.), 453.2 m. (662 kc/s.). Trondheim, 495.8 m. (605 kc/s.), 1.2 kW.; Hamar, 572.2 m. (524.3 kc/s.), 0.7 kW.

have not heard that the new station is at work, though it seems likely that the transmissions that one now picks up are tests of the new plant, for the station is not usually to be heard before about 10 p.m., though after this hour it comes in very strongly. This can hardly be due to any daylight-darkness effect, since it is dark in this country now shortly after 9 p.m., and Hungarian time is an hour ahead of ours.

The pick of the long-wave stations are Kalundborg, Radio-Paris, Huizen, Zeesen and Motala. The last mentioned has improved immensely in the last week or two.

On the medium band Rome, Langenberg, Prague, Hilversum, Heilsberg, Florence, Milan, Strasbourg and Leipzig are amongst the best of the large number of excellent transmissions now available.

D. EXER.

Modulated Pentode Oscillator

For Testing, Ganging or Wavelength Measurements

A PART from the purposes for which they were primarily designed, modern multi-electrode valves have a number of subsidiary applications, many of which have not yet been fully explored. For instance, diode-pentode valves may well be responsible for a revival of interest in reflex circuits.

The multi-electrode valve is particularly useful as an oscillator. The present note deals with the use of a pentode for this purpose in a particularly simple and inexpensive manner. The output is modulated

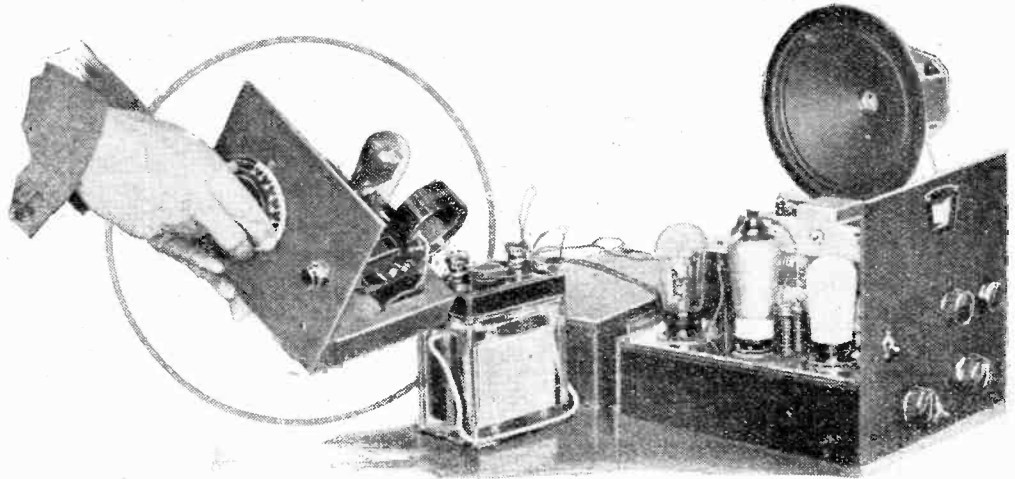

Almost any ordinary battery pentode will oscillate with three or four volts on the anode and priming grid, and so a flash-lamp battery will generally serve as "H.T." There is, however, no harm in using a slightly higher voltage if it is found desirable to do so. Similarly, the values

of grid leak and grid condenser suggested may be changed experimentally, although it is found that the capacity-resistance combination given will produce a very distinctive modulation note, which is easily recognised above an incoming signal when the instrument is used as a wavemeter.

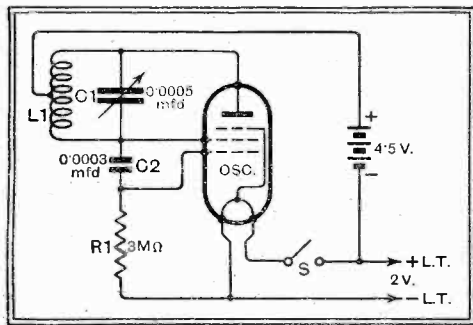

The simplest self-modulating oscillator circuit.

at a suitable audio-frequency by periodic charging and discharging of the grid condenser, and in this respect it is comparable with the original "squegger" oscillator, but is infinitely more stable and certain in operation.

An oscillator of this type can be used for all purposes where a "home-made" signal is required. In view of the impending wavelength changes, its most obvious use will be as a wavemeter; calibration may easily be carried out by noting the dial settings corresponding to a few well-known stations and then plotting these "points" against dial readings on a sheet of squared paper. Whether calibrated or not, the instrument will supply a steady signal for circuit alignment if it be placed near the aerial or earth lead. The oscillator radiation may also be induced into a tuned circuit of the receiver.

In building the oscillator it will be found that layout is unimportant, and that various modifications may be introduced if desired without impairing results. For instance, it might be considered preferable to replace the centre-tapped plug-in coils by an arrangement permitting of a switch wave-change. Unfortunately, however, it seems that no suitable ready-made coil assembly is obtainable.

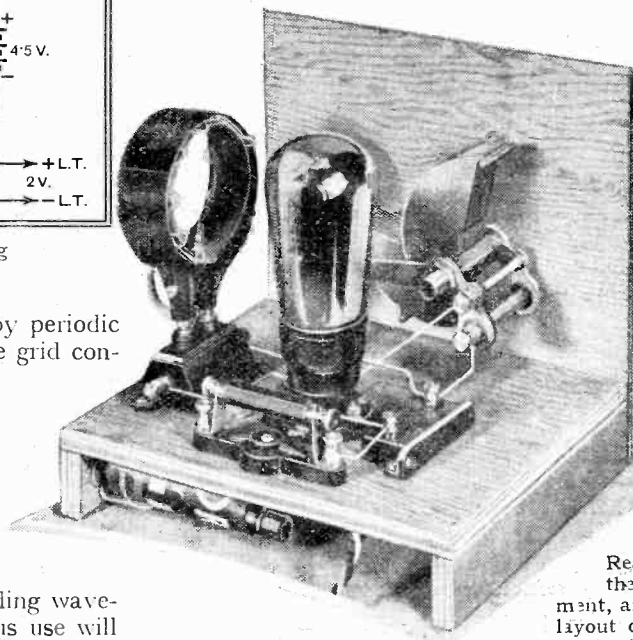

Rear view of the instrument, and (below) layout of components and wiring plan.

The use of an accumulator may be avoided by using dry cells. A 4½-volt battery of fair-sized cells will, as a rule, supply both H.T. and L.T. potentials if the necessary rheostat be joined in the positive lead, the tapping of the coil being connected directly to the positive battery terminal. A battery of exceptionally high capacity will hardly be necessary, as a test oscillator of this type is seldom required to function for long periods.

The following components were used in the construction of the oscillator unit as illustrated: Variable condenser, 0.0005 mfd. (Graham-Farish "Zelos"), on-off switch (W.B.), coil holder (Igranic), dry battery, 4½ volts (Grosvenor), battery clip (Bulgin), grid leak, 3 megohm (Graham-Farish "Ohmite"), condenser, 0.0005 mfd. (Graham-Farish), two coils, centre-tapped, Nos. 60 and 250 (Sovereign), valve-holder, 5-pin (Graham-Farish) and two wander plugs.

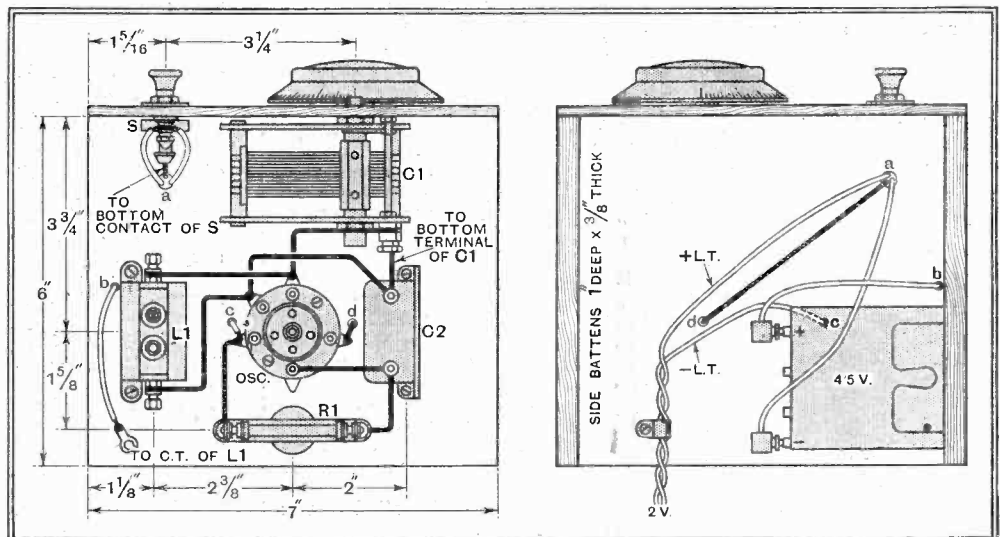

News of the Week

Current Events in Brief Review

No Dabblers

ONLY those who have passed a special examination are in future to obtain concessions for retailing wireless goods in Switzerland. At present there are 2,046 registered traders.

Making America Think

ACCORDING to our Washington correspondent, America is watching with keen interest the B.B.C.'s experiment in introducing a woman announcer. This is something which the American networks have never undertaken.

Fecamp on 700 Watts

RADIO NORMANDIE is shortly to reduce its power to 700 watts by order of the State authorities. Since 1928, when the station began to achieve fame, there have been successive power increases, and the present official output is 10 kW.

More Licences

AT the end of July 5,626,000 wireless licences were in force in Great Britain, this being a net increase of 27,700 in a month.

During the same month 255 "pirate" prosecutions were successfully undertaken by the Post Office, and the total fines imposed amounted to £257 14s.

Five-metre Field Day

ULTRA-SHORT-WAVE enthusiasts in the London area will be glad to know that a 56 m.c. field day is to take place at the Orange Tree, Totteridge, nr. High Barnet, from 10 a.m. on Sunday, September 3rd. The arrangements are under the auspices of the 12th District of the Radio Society of Great Britain.

From Long to Short

SWITZERLAND'S latest long-wave regional station, at Monte Ceneri, which serves Italian-speaking Switzerland, is to be closed down until the middle of September to permit of the necessary changes for altering the wavelength in accordance with the Plan de Lucerne. From January 15th onwards Monte Ceneri will broadcast on 250 metres.

A Dire Threat

SO far as we are aware no listener in Great Britain has ever received a Post Office threat such as that which reached a *Wireless World* reader in Perak, Federated Malay States. The final reminder from the postmaster was in these terms: "Sir, I have to remind you again that your subscription for 1933 in respect of a wireless receiving licence has not been renewed. All services not renewed before the 16th Jan., 1933, will be discontinued."

Rather than disappoint his fellow-listeners our correspondent paid up!

Majorca Calling

AT Palma, in the Island of Majorca, a broadcasting station is nearing completion which will serve the Balearic Isles. The transmitter is testing with the call sign EAJ13.

Wireless on Wheels

HAVING exhausted all the possibilities of radio transmitter hunts, the Sarthe (France) Radio Club has "found a new formula" in a rally of radio cyclists. Each rider will carry a receiver in this interesting field day, which is booked for October next.

"Radio House" Tragedy

BEFORE it was finished, the Danish "Radio House," built three years ago, was found to be too small for its purpose. The plans were criticised by the broadcasting authorities but,

Radio Fever in Denmark

TODAY (Friday) sees the opening of Denmark's Wireless Show in the "Forum," Copenhagen's great Exhibition Hall. The inaugural ceremony is to be broadcast by the new 60kW. transmitter at Kalundborg.

Listen to Bulgaria

SOFIA is to have a new broadcasting station. The existing transmitter, in a disused Post Office in the middle of Sofia, is not equipped with modern apparatus (says the *Manchester Guardian*), but it gives a big daily programme, and few houses in the city are without receiving sets.

Something to Listen to

DR. GOEBBELS, the German "Minister for the Enlightenment of the People and for Propaganda," has presented Signor Mussolini with 203 gramophone

Beacon to Beacon

ARRANGEMENTS have been made for 5-metre tests next Sunday, August 27, in which a chain of stations will be used extending from the Midlands (possibly Worcester Beacon) to Firle Beacon, near Eastbourne, a distance of some 200 miles.

The object of the test is to provide practice in accurate transmission on the "ultra shorts." The transmitters taking part will include G6UH, G2NU, and G5BY.

German Licence Decline

THE decrease in the number of German listeners continues. The total number registered on August 1st was 4,483,278 as compared with 4,521,106 the month previously. Of these no fewer than 531,230 are issued free to unemployed persons, so that the total number of paying listeners in Germany is below 4,000,000.

"Radio Nacional"

THE German Telefunken Company has secured the order for the erection of a 37.5 kW short-wave broadcasting station at Buenos Aires. "Radio Nacional," as the new station will be called, should make itself heard in Europe.

Loud Speakers and Copyright

WHETHER hotels, restaurants, stores, public houses, and other institutions infringe copyright when reproducing broadcast concerts for the entertainment of their customers will be the subject of an important appeal down for hearing for the next Law Term.

At the original hearing Mr. Justice Maughan made a declaration to the effect that the defendants, Hammond's Bradford Brewery Co., had infringed the copyright of the plaintiffs, The Performing Rights Society, Ltd., in regard to certain musical pieces performed by them in public houses under the company's control without the plaintiffs' consent.

A Question of Royalties

FOLLOWING the lead of the Australian Government, the New Zealand Government has given notice to Amalgamated Wireless of Australasia, Ltd., terminating an agreement under which royalty is paid on every wireless licence in the Dominion. New Zealand listeners pay 30s. a year licence, of which 3s. has gone to A.W.A. as royalty in respect of patents and 2s. to the Post Office as collection fee. Over £14,000 was paid by New Zealand in royalties last year, and at the end of March there were 95,580 licences in force. The royalty agreement has been in operation for six years—from the institution of the old Broadcasting Company taken over by the State Broadcasting Board last year—and it is understood that a new arrangement may be negotiated.



ON SNOWDON'S SUMMIT. Mr. E. H. Smith, with his 5-metre transmitter, G6UH, on Snowdon on Saturday, August 12th. Reports were received from considerable distances.

according to our Danish correspondent, the scheme received parliamentary sanction.

Now a new Radio House is projected, and will probably be built on the outskirts of the city.

Photo Cells on the Road

VERY soon every heavy lorry on the French roads may be equipped with a selenium cell device to enable drivers of overtaking motor cars to communicate with the lorry driver. According to the new French Road Code, every vehicle must carry some means of communication between the back and the front, and (says our Paris correspondent) it is quite possible that the selenium device may be made compulsory. An overtaking driver would switch on his headlights, which would immediately affect the selenium cell and operate a warning bell in front. The new accessory is to be installed on all police lorries.

records of interesting political events broadcast during recent weeks. Fifteen of the records comprised the full text of Herr Hitler's celebrated speech in the Reichstag on May 17th.

A New Verb ?

"THE English tongue suffers much from the infiltration of technical jargon," says a writer in *The Daily Telegraph*. "Radio is responsible for some of it. I suppose it is inevitable. None the less I recoil when I read of a device by means of which listeners 'can remote control' a receiver."

Wireless a Necessity

WIRELESS has become such a normal necessity that it is to be regarded as just as essential as electric light," was the considered opinion of the court at Kosice, Czechoslovakia, when a shop-keeper was recently ordered to remove an electric sign which was causing interference to radio.

Ultra Short-Wave Record

Snowdon Transmission Heard at 200 Miles

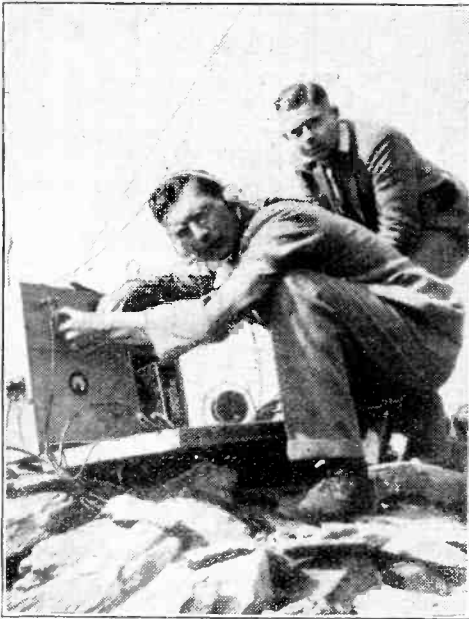

Messrs. H. L. O'Heffernan and H. L. Harris operating G5BY on the summit of Snowdon.

FROM the large circular pile of rocks which marks the highest point on Snowdon (3,570 feet) G5BY, accompanied by G6UH, transmitted on 5 metres for about eight hours continuously on Saturday, August 12th. The summit was reached shortly after 8.30 a.m., and the work of erecting both stations began immediately.

The first transmissions began from both stations at 9.40 a.m. and continued at irregular intervals until 12.20 p.m., when the published schedules were commenced. Throughout the day the experimenters were unaware whether their signals were being heard, for although two receivers were used throughout

OPERATING a "Wireless World" Ultra Short Wave Two" receiver at Hoddesdon, Herts, on Saturday, August 12th, Mr. T. E. Myatt picked up the 5-metre transmissions of Mr. Hilton O'Heffernan (G5BY) from the summit of Mount Snowdon, approximately 200 miles away. The two experimenters have thus broken the world's record for communication on "optical" wavelengths.

each listening period, no answering signal was picked up. This was naturally disappointing but not entirely unexpected, as it was known that very few transmitters were working. In many cases this was due to the fact that many experimenters were unable to participate until the afternoon, it being a Saturday. The test, however, had to be carried out on a Saturday, there being no Sunday trains up the mountain.

It was not until late in the day, when a telegram was received from G2WQ in Manchester notifying reception at 84 miles, that it seemed possible that startling reports might be expected. Obviously, however, the majority of reports would come late and could not be received before Monday or Tuesday. Every post brought fresh evidence of success, culminating on Tuesday by the arrival of a report from Mr. T. E. Myatt, of Hoddesdon, Herts, which checked perfectly with G5BY's log and those of other listeners, thus proving that reception of speech had been achieved over approximately 200 miles from the mountain summit.

G5BY's transmitter employed an eight-foot vertical aerial with the transmitter at the centre. The H.T. of 300 volts was obtained from an Electro Dynamic motor generator driven from a 12-volt car starter battery. G6UH, the companion transmitter, employed a similar layout.

It is impossible to reproduce here the complete log, but the extracts in the accompanying table show how the reports cross-check each other.

How I Logged Snowdon

By T. E. MYATT

MY set, a slightly modified *Wireless World* "Ultra Short Wave Two," was set up on porcelain insulators (to avoid stray H.F.) on a table in a near-by cricket field. The antenna consisted of a roft. length of seven-strand wire suspended by, and insulated from, a piece of string attached to the top corner of a wooden batting screen. An earth connection was made by driving a long screwdriver into the soil and connecting this by a 4ft. length of wire to the set. The ground was extremely dry and had to be damped.

When trying out the set previously I had found that by coupling the aerial by an 0.0005 μ f. trimmer an infinitely higher degree of sensitivity could be obtained.



Mr. T. E. Myatt of Hoddesdon, Herts, with "The Wireless World" Ultra Short Wave Two" on which he heard G5BY's signals at a distance of 200 miles.

A watch was kept from 12.15 (B.S.T.) to 17.30 (B.S.T.). Soon after switching on at 12.25, I picked up the carrier wave of G5BY on 60 m.c. at a strength of R1-2. I held it for about two or three minutes, when a loud burst of "X's" blotted it out. Thereafter no other signals were received until 16.21, when, in the last stages of disappointment and exasperation, I was lucky enough to tune in at R3-4: "This is G5BY testing on a wavelength of 5 metres and 60 m.c." A sudden burst of "sausage frying" indicated the proximity of a plane, which, after circling round the field and blotting out all signals with its ignition, suddenly switched off, and I was able to hear a reference to Mount Snowdon from G5BY. No further sounds from Snowdon were heard; I suppose the interruption was due to the change in the weather, for a bank of heavy clouds rolled up. The watch continued from 16.20 until 17.30.

A number of unidentified Morse stations were logged during the day, though the Brookmans Park transmitters provided an annoying background all over the dial. No doubt I was receiving the sixth harmonic.

A curious feature of the transmission tests was that no trace could be discovered of the other transmitter, G6UH on 56 m.c.

Time B.S.T.	Name.	Location.	Approx. Distance from Snowdon	Reception Strength.	Remarks.
1420	R. A. Bell and J. A. Sugden.	Barras Station.	130 m.	R.2	C.W.
1420	F. H. Jackson, G2KZ.	Liverpool	55 m.	QSA4R5	C.W. code word "ZZQAK."
1520	R. E. Wilkinson, BRS. 107.	Kinder Plateau	100 m.	QSA5R8	Mod. C.W.
1523	J. Davies, G20A	Wallasey	50 m.	QSA5R7	1 C.W. code "YQOD."
1520	G2KZ ...	Liverpool	55 m.	QSA4R5	C.W. code "YQOD."
1620	T. E. Myatt ...	Hoddesdon, Herts.	200 m.	R3-4	PHONE "G5BY testing on a wavelength of 5 m. and 60 megacycles," etc.
1620	BRS. 107 ...	Kinder Plateau.	100 m.	QSA5R9	Good speech, very clear indeed.
1620	G2KZ ...	Liverpool	55 m.	QSA4R5	PHONE calling "Test."
1620	G20A ...	Wallasey	50 m.	QSA5R9	PHONE Now very F.B. indeed "WX fine, sunny and warm."
1620	G2WQ ...	Manchester	84 m.	R.6	PHONE "WX. fine, sunny and clear."
1745	G20A ...	Wallasey	50 m.	QSA5R9	PHONE "Kilox," "close down to get last train from summit at 6.30."
1748	BRS. 107 ...	Kinder Plateau.	100 m.	QSA5R9	PHONE "Final transmission close down."
1746	G2WQ ...	Manchester	84 m.	QSA5R5	PHONE "Kilox final transmission as last train down the summit leaves at 6.30."

BROADCAST BREVITIES

By Our Special Correspondent

Mr. Maschwitz Discloses His Ideas

NOT many young men on the Riviera do as much thinking as Eric Maschwitz did. In between writing revue, etc., the new Director of Variety must have spent his holiday deep in thought. Now he has emerged with a galaxy of ideas of which at least fifty per cent. are real winners and the others runners-up.

The Third Has Not Been Told

When you read this the world may already have become aware of some of these ideas, but I can tell you in confidence that not a third of them have been breathed to more than a very select coterie of friends and admirers.

C. B. Cochran

One superb inspiration was to enlist the services of that super showman, Mr. C. B. Cochran, in the staging of song and dance shows.

You may have heard, too, of the formation of a regular vaudeville chorus—eight pretty dancing girls in uniform—and of the forthcoming "crazy" shows, each of which will pack the old-fashioned "Crazy Month," beloved of the music halls, into one evening.

Saturday Afternoon Vaudeville

Another inspiration is the Saturday afternoon vaudeville hour, to take the form of one surprise item after another in which hitherto unheard-of artistes will make or mar their microphone futures.

"Music Hall"

Amid such a whirl of new things it is strange that the old wharf studio—No. 10—should be selected to play an important part in Mr. Maschwitz's winter plans. Here will be staged two "Music Halls" per month.

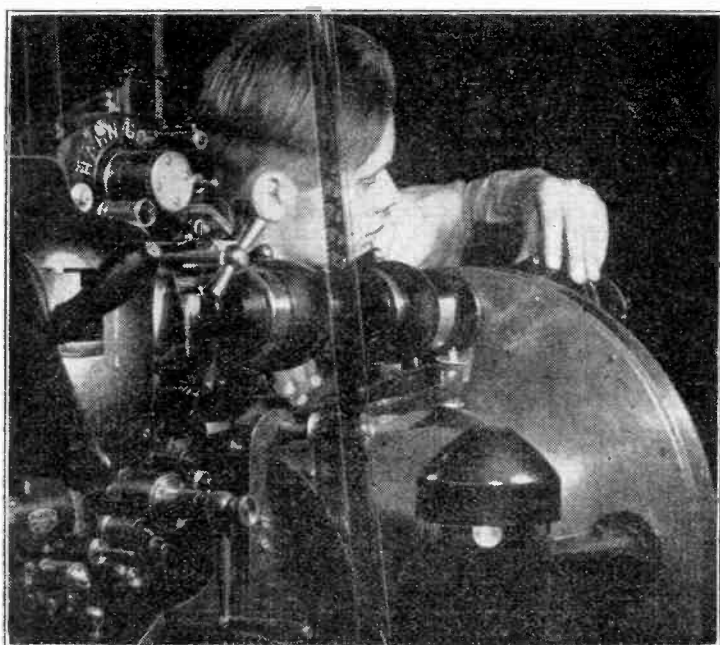

IS IT TELEVISION? An interesting exhibit at the Berlin Radio Show which opened on Friday last, is the Fernseh A.G. television system which employs a continuous band of film. The picture is photographed, developed, transmitted and the film cleaned within twenty seconds. The transmitter seen above gives a 180-line picture at the rate of twenty-five frames a second.

The general feeling in the Variety Department is that no studio at Broadcasting House can equal the old wharf in the amount of "vitality" communicated to the microphone. The audience is not too close to the "mike," and the place has enough echo to conjure up visions of a real theatre.

Drury Lane Success

One of the first-fruits of the Maschwitz regime will be the *Charlot Revue*, to be broadcast on September 11th. André Charlot needs no introduction to listeners as producer and *compère* of innumerable microphone successes. Then there will be the broadcasting of that famous Drury Lane success "The Desert Song" on September 28th (National) and 29th (Regional).

Belfast Expands

WHILE the B.B.C. engineers are caught up in a legal dispute concerning mineral rights with the owners of the projected site for the Northern Ireland high-power station, the Belfast station authorities are calmly forging ahead with plans for vastly improved studios.

National Programmes

A block of buildings adjoining those now occupied has been acquired, and the new accommodation will enable three more studios to be added.

Belfast has been badly hampered in the past by lack of space, but with the improved facilities for band and choir performances it is likely that the station may soon be able to contribute not a little to the National programmes of the B.B.C.

More About the B.B.C. Organ

THE only "mystery" connected with the new B.B.C. organ is that very few organists care to give broadcast recitals on the instrument unless they have had several hours of practice.

At present there are not more than half a dozen executants who are really familiar with the extremely complicated mechanism. One of these is Mr. Taylor of the Compton Organ Company, who on Sunday, September 10th, will broadcast improvisations designed to give listeners an idea of the real possibilities of the organ.

There will be a commentary by Mr. Filson Young.

Radiolympia

THAT'S Radiolympia—that was. The B.B.C. made the most of the stupendous publicity which the R.M.A. was pleased to vouch-

safe them, and many of the broadcasting artistes also enhanced their reputation, if such a thing were possible.

Henry Hall, it is generally conceded, scored a personal triumph.

Hall à l'Américaine

On September 30th, four days after his return from his holiday trip to the United States, Henry Hall will broadcast a feature programme with the B.B.C. Dance Orchestra, entitled "My American Tour." Following a brief description of the places he has visited and the people whom he has met, he will present a series of new American numbers which he is bringing back to this country, and will play them according to the interpretations of well-known dance band conductors by whom they have been presented on the other side.

A Broadcasting Film

IN spite of the coming dissolution of the Empire Marketing Board, the broadcasting film which was being sponsored by the Department will be produced in the near future. I hear that John Grierson will remain in charge and that he is now preparing the scenario and dialogue.

Moments of Mystery

The dialogue will probably be as interesting as anything else in the film. The processes of broadcasting are not so secret nowadays, but the conversations which go on behind the battlements in Portland Place are still wrapped in mystery. I, for one, should like a glimpse of one of those "high officials" gripping the telephone and saying, without the twitch of a muscle, "The B.B.C. has no statement to make."

A Broadcaster's Plight

HOW are the mighty fallen! Philip Ridgeway, who never felt at ease in the broadcast studio unless the toy footlights were on "to give the theatre atmosphere," now confesses to uneasiness on the public platform unless a microphone is handy.

To get over the difficulty on their present seaside tour, he and his company take with them a public-address system. Microphones adorn the stage, and loud speakers give an amplified version of the "Parade" in the auditorium.

Shakespeare on Sundays

WHEN the new schedule of Sunday evening broadcasts starts in the autumn, plays by Shakespeare will be included in the programmes on the second Sunday in each month, starting in October. The plays so far arranged are "Othello," "The Tempest," "Julius Cæsar," and "Two Gentlemen of Verona."

They are Saying in Timaru . . .

IT might be unwise to expect too much of the B.B.C. records that the New Zealand Broadcasting Board has arranged to purchase. The programmes provided for the Empire service are not particularly attractive, and John Bull's broadcasting ideas are like his Rugby rules—a bit stereotyped."

—Timaru Herald, New Zealand.

Marconiphone

MODEL 260

A Battery Receiver with Mains Quality and Volume

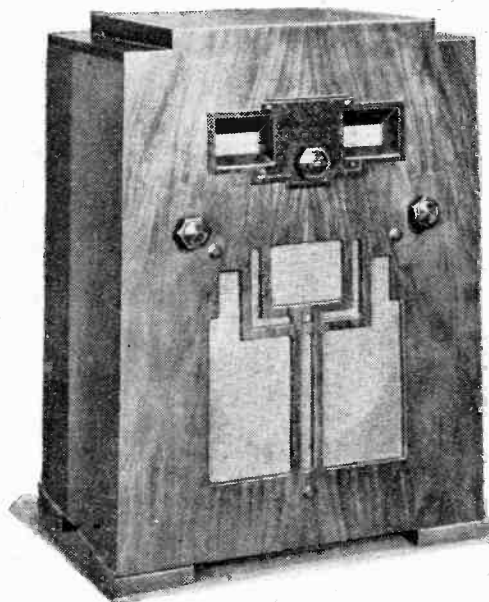

A modified form of quiescent push-pull, known as the "Parallel Conductance Principle," has been adopted in the output stage. The pentode valves used in this stage are classified in the valve factory and marked with distinguishing letters. Tappings correspondingly lettered in the H.T. battery enable the slopes of the valves to be adjusted to a predetermined standard value by inserting the auxiliary grid leads of each valve in the socket corresponding to the letter marked on the valve. The auxiliary grid leads are taken directly from the valve-holders, so that there can be no possibility of error in the event of the purchaser being called upon to make a replacement for himself at some future date.

The design of the earlier stages of the receiver is in keeping with the technical merit of the output stage. A band-pass input filter in the aerial circuit, in conjunction with a tuned H.F. transformer between the screen-grid valve and the detector, combine to give a range and degree of selectivity of a high order for a receiver employing only one H.F. stage.

The sensitivity on medium waves is particularly good, and in daylight excellent results were obtained from Fécamp, Hilversum, Poste Parisien, Langenberg, and the two Brussels stations. On the least selective of the aerial tappings (Ar) London Regional, at a distance of fifteen miles, extended from 340 to 380 metres and the National from 245 to 275 metres. No difficulty was experienced in receiving the Brussels No. 2 programme without the slightest trace of interference from London Regional. On long waves the range is equally good, and sufficient selectivity is provided to give easy separation of

FEATURES.
Type.—Open aerial four-valve table model battery receiver with modified O.P.P. output stage and moving coil loud speaker. Provision for gramophone pick-up and external loud speaker.
Circuit.—Screen grid H.F. stage with band-pass input and tuned transformer coupling—grid detector with reaction—O.P.P. output stage.
Controls.—(1) Tuning, with illuminated dial calibrated in stations and wavelengths. (2) Combined volume control. (3) Wave-range switch. (4) On-off switch. **Price.**—£11 17s. 6d. (complete with valves and batteries). **Makers.**—The Marconiphone Co., Ltd., 210/212, Tottenham Court Road, London, W.1.

Daventry and Radio Paris, but not quite sufficient to free Königswusterhausen from

TO anyone who has not had experience of the new battery output stages the performance of this receiver will come as a revelation. In the matter of volume and quality it is quite the equal of the majority of mains receivers which we have tested, and it is at first difficult to believe that such results can be obtained for an average H.T. consumption which is well within the capacity of the normal size of H.T. battery.

The loud speaker unit is of the permanent magnet moving-coil type, and, while there is ample bass response, the quality cannot be described as woolly, as it is balanced by a bright and crisp upper register. It is fascinating in a battery receiver to be able to increase the volume to a level much higher than is normally required in the average living-room without being able to hear the slightest trace of overload distortion.

Actually, the undistorted output is rated at 1.3 watts, and measurements of the total H.T. current show that it fluctuates from 6 mA. in the quiescent state to 18 or 20 mA. for sustained loud passages. For the purpose of estimating the probable life of the H.T. battery the average current at normal volume may be taken as 9 mA., which is about the same as that of earlier types of battery receiver giving an output of only 300 or 400 milliwatts.

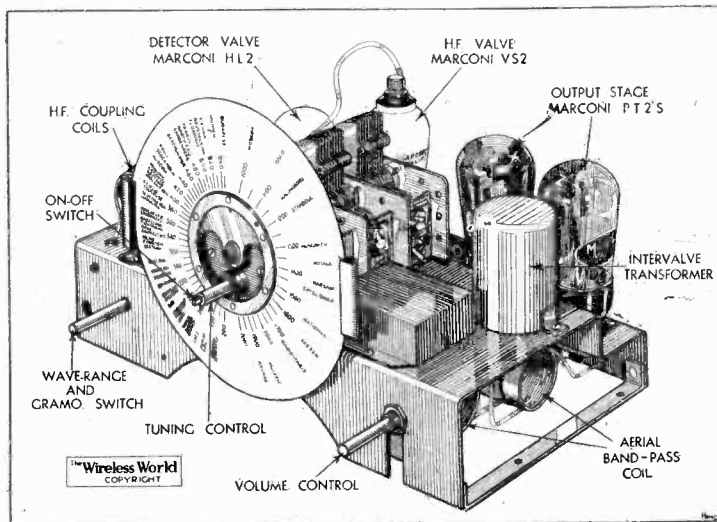

The Marconiphone Model 260 chassis. Careful disposition of the tuning coils has eliminated stray couplings without having to resort to screening boxes.

a background from the long-wave B.B.C. station.

Volume control is effected simultaneously at three points in the circuit—by reducing the aerial input, by lowering the screen-grid potential, and by reducing the current in the reaction coils coupled to the tuned H.F. transformer. It is interesting to note that a single potentiometer is used to govern the screened potential and the reaction current. The aerial volume control consists of a variable series resistance ganged to the screen grid and reaction potentiometer.

There are many points of interest in the chassis layout. The tuning coils, for instance, are not enclosed in screening cans, which would increase their H.F. resistance, but are carefully disposed in relation to one another to avoid stray couplings. The aerial band-pass coils are ar-

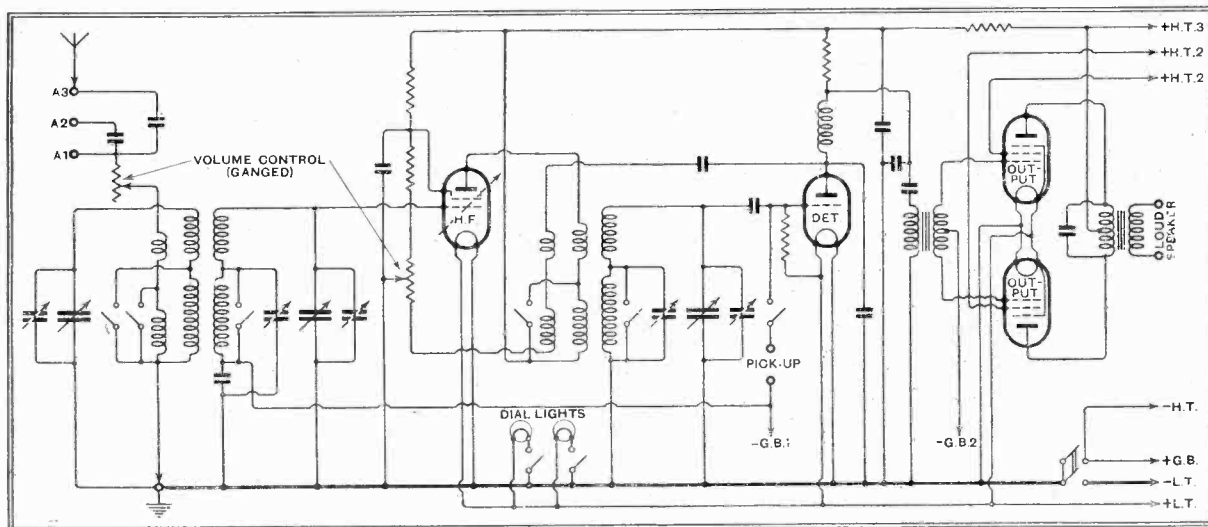

Complete circuit diagram. The volume is controlled by reducing simultaneously the aerial input, the screen grid potential and the current in the reaction coil by means of ganged resistances.

Marconiphone Model 260—

ranged below, and the H.F. transformer above, the base-plate. The three-gang tuning condenser is operated by a large-diameter translucent dial calibrated both in stations and wavelengths. It is steadied at the edge to prevent buckling by two felt-lined guides and is viewed through two adjacent windows in the escutcheon plate, which is illuminated by dial lights controlled from the wave-range switch. The on-off switch

interrupts both the H.T. and L.T. circuits, and is operated by a subsidiary control concentric with the main tuning knob.

The cabinet is of good quality, and the design is arranged so as to give ready accessibility to valves and batteries. A point which is typical of the thought which has been put into the whole design is the provision of a paxolin-lined metal container to isolate the L.T. accumulator from the H.T. battery.

mock-technical Press has become almost nauseating.

Like you, I can find plenty about which to criticise the B.B.C. They seem, too, to have a genius for perpetrating at odd moments something which is quite inane. But on the whole there is no question that the programmes are at a very high level indeed, amazingly good considering how much time there is to fill. And that is probably at the root of the whole matter. Too much time.

Brighton.

A. H. BRIDGES.

Correspondence

The Editor does not hold himself responsible for the opinions of his correspondents
Correspondence should be addressed to the Editor, "The Wireless World," Dorset House, Stamford Street, London, S.E.1, and must be accompanied by the writer's name and address

Why Kill the Goose . . . ?

MAY I commend very heartily your editorial comment "Why kill the goose . . . ?" in the last issue of *The Wireless World*.

It is, as you say, an absolute fact that the service given by the B.B.C. is quite the best to be found anywhere in the world. It seems to me that it is unreasonable to expect to be amused or interested at all moments of the day, and, after all, the grumbler has only to switch off or switch over.

At any rate, let us be thankful that our programmes are not continually interrupted by eulogies of Messrs. So-and-So's "Cure-all Pills," or whatever it may be.

By all means let us suggest to the B.B.C. improvements in this or that detail, but at the same time let credit be given to them for a very fine general service.

Good luck to *The Wireless World*, not forgetting "Free Grid" (long may he continue to criticise!).

A. I. BRAY.

London, N.3.

Programmes

MAY I, as a constant reader of *The Wireless World* since its first issue, take exception to the article entitled "Programmes" in your "Editorial Comment" published in the current issue.

I have always admired your outspoken and unbiased comments, and you may justly claim to have done more to help and encourage the wireless industry than any other periodical.

However, you cannot always correctly express the views of the majority, and I am afraid that, in the case of this particular article, you have shot rather wide of the mark.

You ask, "Why kill the goose?" Suppose that the goose is seriously ill and likely to die in any case unless it receives expert attention? Surely, despite a multitude of "quacks," we would pay attention to the advice of the specialists.

To anyone in possession of such a receiver as your "New Monodial Super," your statement that "no country in the world can expect better entertainment transmission than we get here" must appear incorrect. And, if one has the fortune to possess a S.W. adapter to use in conjunction with that receiver, your statement is open to ridicule.

I do not wish to occupy your valuable space in making comparison between the B.B.C. and foreign programmes, but will suggest that you invite the views of "long-

distance listeners." You will surely receive an eye-opener.

Naturally, those who have never owned a long-range receiver or only possess one of poor performance or quality, are totally unqualified to make any programme comparison whatsoever.

As a designer of receivers, I have, without exception, always been requested to design receivers which are capable of good long-distance reception, and, in several cases, to the total exclusion of the programmes transmitted by the omnipotent B.B.C.

There will be much sleep lost by designers after January, 1934, when the Plan de Lucerne comes into full operation. We shall be certainly hard put endeavouring to explain to a non-technical public the reason why, for instance, "Jerusalem the Golden" persists in his whistling accompaniment to programmes emanating from the North Regional. One has only to glance at the new wavelength plan to note that Great Britain has again been left "to hold the babe." Yet this plan was agreed to by representatives of the Post Office and the B.B.C.

Were it not for continued criticism, I shudder to think of the type of so-called programmes of entertainment and the quality thereof which would be polluting the air.

Regarding the subject of quality. I need only refer you to letters and articles, written by experts, published in *The Wireless World* from time to time, and you can but admit that many of the B.B.C. transmitters are very much "down." Further, I need not refer to the adverse criticism from the Colonies regarding the programmes and quality transmitted by our famous S.W. stations.

Yes, sir, a "cure" is needed, and it is only when our goose is placed on show with the rest of the flock that notice will be taken of its ills, and then, with co-operation, we may save its life.

In conclusion, I consider the mere fact that a Broadcast Listeners' Protection League is already in the course of formation in the North of England is ample proof of the views of the public in general.

Liverpool. "ALTRUIST."

I CANNOT tell you how your editorial on the subject of B.B.C. programmes has delighted me. As usual, *The Wireless World* stands for sense and reality, and refuses to pander to cheap popularity. The drivel, which is called criticism, that has been appearing lately in the lay and

Television

MY letter on television seems to have aroused some little interest, unfortunately only in the South, which is somewhat adequately catered for, and allows some scope for your correspondents to acknowledge their indebtedness to the B.B.C. for their television transmission.

My query as to "What is this television?" still remains very unsatisfactorily answered, except to the extent that some people who pay 10s. a year are catered for, and others who also pay are not catered for, which is quite typical of the usual treatment of the North by the B.B.C. (Have you ever heard the Northern Studio Orchestra? If you have, my point will be emphasised!)

I have been to most of the Wireless Exhibitions in the South, and all those in the North, and my nearest approach to seeing television was standing in a queue at the Ideal Home Exhibition, when I decided that life was too short even to wait in that.

I thank the Edison Swan Co. for their literature. It is interesting, but the Pennines are high and full of iron, so for the present my experiments must wait!

Your other correspondent's acidly personal letter can be treated with the contempt it merits. There are many obvious replies, so obvious that I will refrain from using them. LOUIS J. WOOD.

Hon. Sec., Halifax Wireless Club

(since 1919).

Deaf Aids in Cinemas

WITH reference to "Free Grid's" claim that cinema installations for the deaf were fitted in accordance with his suggestion in your issue of March 24th, we would like to point out we have installed cinema sets for the Gaumont British Picture Corporation and other circuits for over eighteen months now.

More are being installed daily, as the system is proving of great benefit to the cinemas and their deaf patrons.

London, W.1. "ARDENTE."

Continuity of Electric Supply

AT a time when many electricity supply companies are being converted to the standard frequency and voltage of the national "grid," I think many consumers would be interested if any of your readers could throw light on the obligations, if any, incumbent on the suppliers in respect of continuity of supply.

This village has been on the standard frequency for five years, and there are interruptions at the rate of two or three a fortnight. Of short duration, these breaks do not usually come at a time when light or radio reception is affected, but it is a source of "inconvenience" in respect of clocks and cookers, irons, etc.

Protest to the company does not elicit any satisfactory reply. GERALD LUSH.
Somerset.

The Wireless World

THE
PRACTICAL RADIO
JOURNAL
23rd Year of Publication

No. 731.

FRIDAY, SEPTEMBER 1ST, 1933.

VOL. XXXIII. No. 9.

Proprietors: ILIFFE & SONS LTD.

Editor:
HUGH S. POCOCK.

Editorial,
Advertising and Publishing Offices:
DORSET HOUSE, STAMFORD STREET,
LONDON, S.E.1.

Telephone: Hop 3333 (50 lines).
Telegrams: "Ethaworld, Watloo, London."

COVENTRY: Hertford Street.

Telegrams: "Cyclist, Coventry." Telephone: 5210 Coventry.

BIRMINGHAM:

Guildhall Buildings, Navigation Street, 2.

Telegrams: "Autopress, Birmingham." Telephone: 2970 Midland (3 lines).

MANCHESTER: 260, Deansgate, 3.

Telegrams: "Iliffe, Manchester." Telephone: Blackfriars 4412 (4 lines).

GLASGOW: 26B, Renfield Street, C.2.

Telegrams: "Iliffe, Glasgow." Telephone: Central 4857.

PUBLISHED WEEKLY. ENTERED AS SECOND CLASS MATTER AT NEW YORK, N.Y.

Subscription Rates:

Home, £1 1s. 8d.; Canada, £1 1s. 8d.; other countries abroad, £1 3s. 10d. per annum.

As many of the circuits and apparatus described in these pages are covered by patents, readers are advised, before making use of them, to satisfy themselves that they would not be infringing patents.

CONTENTS

	Page
PROGRAMMES FROM ABROAD, pp. I-XXIV	
Editorial Comment	189
Thunder and Lightning	190
Unbiased	192
Simple Measurements on Receivers and Components	193
News of the Week	195
Practical Hints and Tips	196
The Iconoscope	197
New Class "B" Output Valve	198
Binaural Reception	199
Thoughts on Olympia	200
Glasgow Show Plan and Guide	202
Broadcast Brevities	203
Correspondence	204
Readers' Problems	205

EDITORIAL COMMENT

Broadcasting Hours

Are They Too Long?

A RECENT Leader in which we called attention to the unwarranted amount of criticism levelled at the B.B.C. programmes has brought us a number of letters from readers, one or two criticising us for championing the B.B.C. programme policy, but the majority endorsing heartily our point of view that much of the criticism of programmes is undeserved. We take note, in particular, of the remarks of one correspondent, who, whilst agreeing that the average of the programmes is good, contends that the task of maintaining good programmes over so many hours is a well-nigh impossible one and consequently we cannot expect to avoid the probability that some portion of the matter sent out will be of poor standard.

We have ourselves from time to time in the past raised the question as to whether the B.B.C., in compiling new programmes for so many hours, is not setting itself a rather impossible task. Separating entertainment and the talks from those portions of the programme which may be regarded as service, it would seem that there is room for a certain amount of repetition without spoiling the present character of the programmes. The alternative programme scheme seemed to pave the way for economies of this nature, for we could then have a first-class programme repeated from other stations on different evenings of the week. If this repetition never takes place many fine broadcasts are missed by a proportion of listeners because their other engagements have made it impossible to listen-in at the particular time the broadcast took place. To have a second chance of listening-in

to all the more important broadcast performances would be an undoubted benefit to listeners in general. It would, incidentally, reduce the number of hours when fresh material had to be provided for broadcasting, and it is possible that in some instances it would be permissible for "repeat" performances to be carried out through the medium of records of the original transmission.

Television Post Cards

The Purpose of the B.B.C.

WE mentioned in last week's issue that the request which is now being made to those who see the broadcast transmissions to send a post card to the B.B.C. is for the purpose of arriving at some idea of the size of the television audiences of these broadcasts.

This action on the part of the B.B.C. is, we understand, a direct result of a suggestion put forward by *The Wireless World* some time back that it was of importance to everyone concerned in the development of television in this country to have this information.

We have noticed that in certain directions this action on the part of the B.B.C. has been interpreted as being intended to provide an excuse for the B.B.C. to discontinue the transmissions when they find that they have a very limited audience. We do not think that there is any reason to feel anxiety on this score. The B.B.C. has a contract to continue these transmissions for some considerable time to come and, in any case, it is obviously absurd to suppose that if there was sufficient justification for starting a year ago, there is any excuse for stopping transmissions now, at a time when so many new developments seem likely to emerge shortly from the experimental stage.

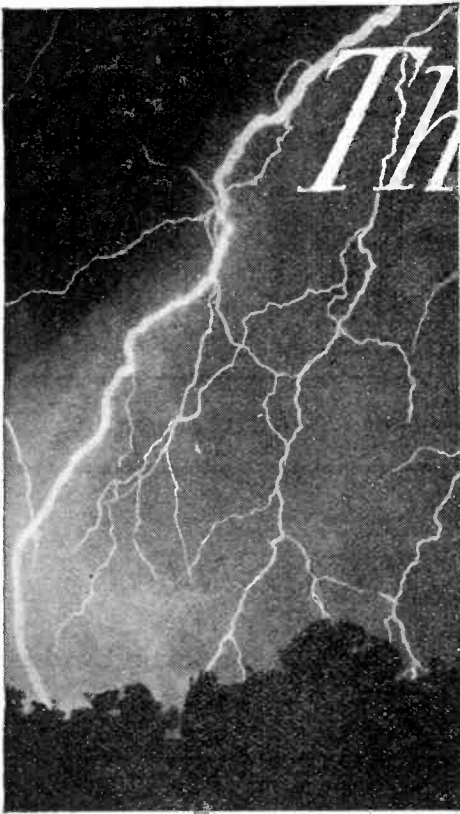

Thunder and Lightning

How Wireless Aerials are Affected

By J. F. HERD, A.M.I.E.E.

AERIALS were at one time popularly believed to act as a kind of collector of lightning discharges. Experience shows that aerials are very rarely struck during the thunder season in comparison with the number of lightning discharges that take place. This summer has proved to be no exception.

THE thunderstorm season has been and is still with us and appears, from newspaper accounts, to have had its usual crop of things, including aerials, "struck by lightning." This always serves to remind us—at least to remind me—how extremely little we know yet about this, one of Nature's oldest and most magnificent phenomena.

Whether he likes it or not, the wireless enthusiast is compelled to affect some interest in thunder and lightning, since lightning discharges are believed to be the cause of most if not, indeed, all of those atmospheric phenomena which so often militate against summer-time reception, especially on the longer wave band. In passing, too, it is to be recalled that Popoff—a Russian scientist, not the perhaps better-known character in "The Merry Widow"—actually used an elevated aerial to observe the effect of distant thunderstorms, wireless atmospheric, a year before Marconi used the same arrangement to radiate controlled wireless waves.

Isolated Targets

Although the daily press reports grizzly details of things struck by lightning, it is surprising how rarely this occurs and how little damage is done by these amazing impulses. Incidentally it is very noticeable that wireless aerials are by no means readily struck. Many Jonahs of a few years ago regarded every aerial as a potential collector of lightning flashes and envisaged them being struck in their thousands. One simple explanation is obvious. It is that the *average* domestic broadcast aerial is not incomparably high with regard to its surroundings, and is therefore in no greater prominence from the point of view of attracting, as it

were, a concentrated field to facilitate a discharge path. It is well known that a single tall tree, standing, for example, in splendid isolation in the middle of an open space is one of the worst forms of shelter that one can seek from rain in a thunderstorm. In such a case there is a definite possibility of the tree acting in the manner described, while, once it is struck there is the well-known possibility of "side-flashing" from the trunk of the tree to persons standing beneath its shady boughs. It is side-flashing of this type which is always the danger to the vicinity when any object is struck by lightning.

The same erratic tendency is seen in the lightning flash itself, giving the zig-zag appearance so familiar. These erratic tendencies can be observed in artificial high-voltage discharges—discharges much less in intensity than those produced naturally. For example, watching successive flash-overs at the National Physical Laboratory high-voltage plant, the erratic nature of the path can be seen changing even during one flash-over. The longer zig-zag path—rather than the straight and narrow one—is due, apparently to differences of ionisation in different parts of the air, causing the longer geometrical path to be, from the electrical point of view, the shorter.

It is interesting to consider the enormous electrical quantities contained in a lightning flash. It is, of course, impossible to make any direct measurement of the effective current in the discharge itself, but it is possible to infer typical values from its effect on circuits and instruments of known electrical dimensions at known distances from the flash.

The classical work on this subject is

that of the Cambridge scientist, Prof. C. T. Wilson, who has estimated that the potential reached in a thunder cloud just before the discharge is of the order of one thousand million (10^9) volts. Professor Wilson has also estimated that the discharge involves a displacement of the order of 20 coulombs in a period about one thousandth of a second, giving a mean current of about 20,000 amperes. This is, of course, the average value during the time of the discharge and must be greatly exceeded at some process of the discharge. It appears possible that instantaneous values of over 100,000 amperes are reached. The electrical power associated with a lightning flash is thus several thousand kilowatt hours. All of this energy does not, of course, appear at the earth's surface, since much of it is used up in the air channel. Many

of the most powerful strokes, however, must deliver a large proportion of their energy to the earth.

A fairly reasonable domestic load for all lighting and a number of electric power appliances works out at between 1,500 and 2,000 kilowatt hours per year, so that a single lightning discharge has enough energy to keep a modern suburban dwelling fully electrified for about a couple of years. No wonder things happen when

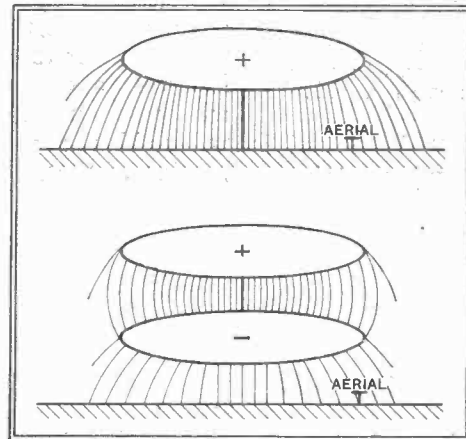

Showing how an intense electric field may be built up about a wireless aerial due to a thundercloud, even when the aerial is not in or near the path of the final discharge which is shown in heavy line.

this supply is released in a thousandth of a second!

The above figures of current and voltage help to explain such things as the side-flashing already mentioned. For example, in the case of the simplest lightning conductor the wire may have to carry a current of well over 20,000 amperes, so that every ohm of resistance in it has a drop of over 20,000 volts across it. A local resistance or bad connection, or a

Thunder and Lightning.—

bad earth amounting to ten ohms may thus raise the potential to well on towards a million volts. Apart from the heat developed at the resistance, this will give definite tendencies to side flash if the discharge can gap over a length of air which is easily ionised and made conductive.

In the case of a wireless aerial acting as an involuntary lightning conductor, the presence of anything giving a high impedance to earth would thus explain the various erratic things that have been described in cases where aerials have been struck. In a case described in one well-written technical account, which the writer had the chance of seeing, a series aerial condenser was completely shattered for reasons which are obvious from the above argument. The inside of the set was described as looking as if it had been sprayed liberally with pitch. Side flashing also occurred from the aerial to a lead base round the chimney stack, and at two different places in the wall beside the down lead.

It is well known that some lightning discharges take place between cloud and earth while others occur from cloud to cloud. This is quite apart, of course, from the so called "summer lightning" when the sky is widely illuminated, especially towards the horizon, by the reflected effects of flashes that may be many miles—even a hundred miles—away. Experts are not agreed as to the proportion

of lightning flashes which are of the cloud to earth or the cloud to cloud variety. Neither are meteorologists fully agreed about the exact mechanism which gives rise to the thunder cloud and its enormous electrical charges. Although this would appear to have a distinct bearing on the nature of the discharge. Despite the small number of earth-surface casualties that occur (in relation to the total number of lightning flashes) one has the impression that there have been more such casualties this summer than one usually sees reported.

We are Still Learning

Does this then mean that these summer lightning-storms have been characterised by a greater number of cloud-to-earth strokes, or is it just bad luck? The wireless investigation of atmospheric is, of course, helping to cast light on thunder-

storms, and wireless methods are now available for revealing both the place of origin and the nature of the impulse received at a distance. At the last N.P.L. annual invitation visit, a cinema film was exhibited showing the cathode-ray direction finders which reveal the direction of individual atmospheric. It has been estimated that taking the world as a whole there are about 1,000 lightning discharges per second at any time. The figures of kilowatt hours thus wasted during the course of a year simply do not bear thinking about.

Apart from the case of an aerial being directly hit by lightning there are still possibilities of considerable inductive effects due to lightning. During the process of building up a thundercloud there are very considerable electrostatic fields created between cloud and earth. This can be seen from the diagram on the previous page. Here an aerial can be in an intense electric field even though it is not below the point where discharge finally

even with many that are not actually visible but where the aerial is nevertheless within the extensive region that has come under the wide scope of this electrostatic field. In addition to this more or less local effect the sudden destruction of this field has the effect of setting up an electromagnetic wave which travels out into space in the form of an atmospheric—a natural signal sent out by a powerful transmitter with an excellent large radiating aerial!

Protecting the Aerial

Despite the few cases of wireless aerials being struck by lightning, there seems no doubt that protection of the domestic aerial from the effects of lightning—even from the relatively minor induced charges just described—is a real and wise precaution. Many earthing devices exist, and most outdoor aerials are fitted with some such device. For the best protection it is usually recommended that the

earthing switch should be outside the house and suitably protected against weather. This unfortunately results in it not being used, particularly as a routine method overnight or when the house is unattended. Some meticulous citizens might manage to remember it, but one fears that the average man is rather casual about it. The next best technical solution, and one much more likely to be used, is to have an indoor switch

immediately at the point of entry. Best of all however, is an automatic device which needs no switching, and gaseous conductors are now available for the purpose, fitted usually, with the familiar serrated edge spark gap or "lightning arrester." In fitting the aerial, too, precautions may be taken to minimise the possibilities of side-flashing. Broadly, these can be summed up in the form of keeping down resistance and inductance of down-leads and even more, of earth-lead. Sharp bends in the down lead should be avoided, and the earth-lead should be as short and straight as possible—as indeed it should be in any case.

There is very little chance of an indoor aerial being struck unless the whole house "gets it." Induced voltages of the type described, are still set up in an indoor aerial, but switching protection is hardly necessary except in the very nearest of discharges.

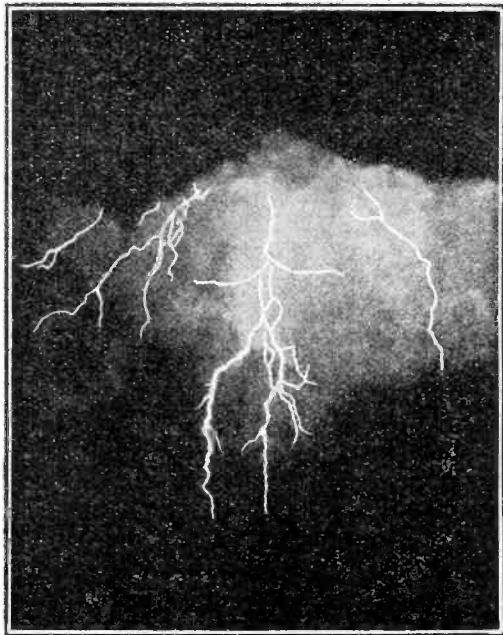
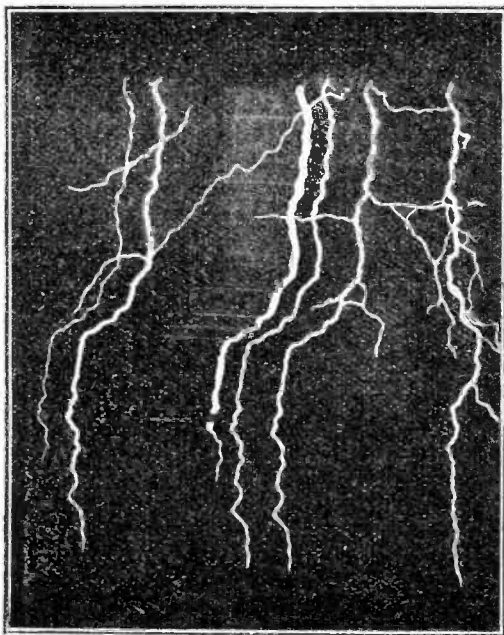

Photographs of a lightning flash, the left-hand picture was taken by camera moving from right to left; the right-hand picture is of the same flash taken by a stationary camera.

occurs. Even in the case of what ultimately becomes a cloud-to-cloud discharge, not hitting the earth at all, immediately prior to the discharge the lower side of the cloud nearer to the earth gives rise to extremely high electric fields at the surface of the earth. These fields, even although they are static or in the process of slow building up, will obviously have an effect on aerials in their vicinity. When the aerial has a low d.c. path to earth this does not matter, but a series condenser giving a high resistance d.c. path to earth may get uncomfortably charged. A series air condenser in a big aerial can often be seen to spark due to this cause. In either of these cases the sudden destruction of this electric field (due to the discharge taking place) gives rise to the induction of a big transient voltage in the aerial. This is, of course, the very strong atmospheric which is heard when a visible flash occurs, and



Accelerating the heart beats.

Reminiscences

EVERYTHING this year seems to have militated against my getting a view of the Olympia Show, and if it had not been for the solace afforded by *The Wireless World Show Report* I should have been plunged into a barren sea of utter despair. I have already told how the carelessness (or carefulness?) of a van driver outside Olympia laid me low when I was just in sight of the Delectable Country. Thereafter, from my sick-bed I tried to obtain first-hand day-to-day Show reports, but was thwarted by the fact that the little Grid Leaks, the only people I could have relied upon, were away at a wretched holiday camp in the wilds of Central Europe. Ultimately I had to fall back on the services of Mrs. Free Grid, of whom I will say that she did her best. She provided me with a sort of "bird's"-eye view.

Among other things she reported a truly distressing lack of grammar on the part of the exhibition authorities, since, over every entrance door, was printed a large sign: "NO PASS-OUTS." The expression "pass-out" is uncouth enough without such a glaring mess-up in the plural.

Apparently the most spectacular exhibit, notwithstanding the B.B.C. show, was that provided by the General Post Office, and I was rather pained to hear that a thing that attracted most people to the G.P.O. section savoured more of a side-show at Hampstead Heath on a Bank Holiday than a demonstration at a serious scientific exhibition. This was an apparatus for reproducing heart-beats on a loud speaker, where the microphone was held in the cardiac region. The arrangement, I was told, was superintended by a damsel who applied the microphone to the chests of young men and demonstrated how her close proximity accelerated their heart-beats.

I was grieved to learn that the Show revealed one of the features which disgraces certain other exhibitions held at Olympia, at which it is quite impossible to proceed from stand to stand without being followed by a parasite in the form of a part-exchange dealer pestering one with the

UNBIASED

By FREE GRID

enquiry: "Thinking of making a change, sir?"

Two or three young men at the Radio Show were armed with forms which, after requesting details of a set which an intending customer might think of exchanging in part payment for a new one, asked the singularly naïve question: "Is the tone, sensitivity, and selectivity of your present set good, bad, or indifferent?" Do the mutts honestly think that, faced with such a question, the customer is going to cry "Stinking fish"?

Big Business

I REALLY think that when it comes to exhibitions the wireless people must be the envy of every other industry in the country; in fact, judging by the way the business flows in at Olympia, I cannot for the life of me see why they keep the Show open for more than one day, or at the outside two; and neither can I understand why every business man in the country doesn't sell out all his other interests and get into the radio business without delay.

One well-known firm, with a factory many acres in extent, stated that they sold the whole of their output up to Christmas time before the Olympia Show was an hour old. Quite a number of firms nearly equalled this record, and one firm of international repute exceeded it, for they announced that during the run of the Show they had sold all their factory output for two years.

I do seriously think that, for the good of the radio industry generally, this blatant bunk ought to be suppressed.

Those Crystal Sets

I HAVE been overwhelmed in such an avalanche of letters and offers of help as the result of my note the other week concerning the dearth of crystal sets and parts thereof that I scarcely know how to thank readers. Not only did I receive letters giving me the addresses of numerous establishments where I could still buy



At knock-out prices.

crystal sets, but a large number of readers were kind enough to search over their old discarded radio gear and send me bits and pieces sufficient to make a very handsome crystal set.

In addition, many others offered me complete sets at knock-out prices. I am astonished to learn that they do exist in quite considerable quantities in various shops. One well-known dealer in wireless gear whose establishment I overlooked in my original quest, although it was well known to me, forwarded me his catalogue showing that the humble crystal set is still listed. I must confess, however, that I was considerably astonished to hear from the Editor that a well-known London firm had written to him stating that they sold over one thousand gross of crystals during the last radio season, more especially since another well-known crystal expert has written to inform me that, so far as he is concerned, the crystal trade has dwindled to vanishing point. Still, we live and learn.

A Souvenir

WOMEN never seem to be able to go anywhere, even for a day's visit, unless they bring back a wretched present or souvenir for somebody at home, even if



Functions beautifully.

it only be a paltry china ornament with "A Present from Margate" scrawled on it in gold letters, and Mrs. Free Grid's visit to Olympia was no exception. In this case, however, it was an extremely useful present, consisting of a volume control which is mounted on a weighted strap for slinging across the arm of the fireside chair in much the same way as certain ash-trays. The volume control functions beautifully, the "control" being spread nicely over practically the whole movement of the knob instead of crowded up at one end as in the case of some of them.

Everything in the garden was lovely until I became so satisfied with my present that I wished to buy another. I need scarcely say that, as is the way of all women, Mrs. Free Grid had completely forgotten the name, or even the exact locality, of the stand whence she bought it. The result is, of course, that my desire to possess a spare one has increased a thousand-fold; indeed, it has almost assumed the dimensions of the cravings of a drug-addict.

Simple Measurements on Receivers and Components

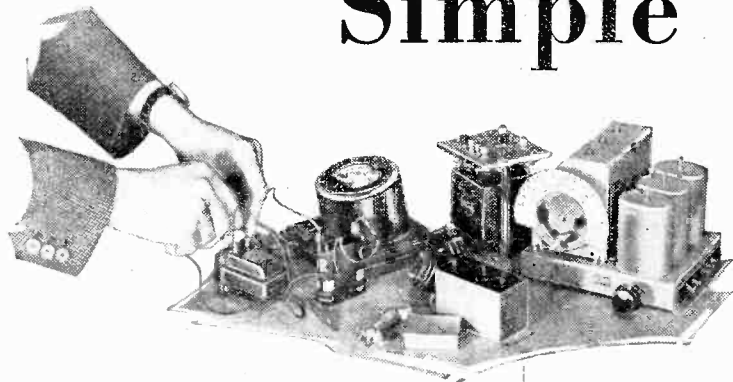

A MODERN wireless receiving set is unquestionably a somewhat complicated piece of electrical apparatus, with many components, each of which must function properly if the set is to give the best results. The valves, of course, are the most important of these components, and, even though they may be faultless, their efficient operation and their span of useful life depend on the correct voltages being applied to their various electrodes. For instance, if a grid bias voltage is too low the anode current may be excessive, and, apart from the lowering of efficiency and the introduction of distortion, the emitting cathode of the valve itself may be impaired.

It is perhaps a little surprising to find how often the electrical conditions prevailing in the circuits of a newly constructed receiver are left to chance, even by those who exhibit quite a high degree of skill in constructing their own sets, either from specifications such as those given from time to time in *The Wireless World* or from designs of their own. The assumption is commonly made that, the greatest care having been taken in following the constructional data, and in making theoretical calculations, everything is bound to be well from the electrical point of view! This may be so to a certain extent in many cases, but how much trouble and doubt may be avoided if only a simple measuring instrument such as a milliammeter were available.

Testing a New Set

When the set is completed and the valves are carefully put into their sockets comes the thrilling moment when the first trial is to be made, and the final adjustments effected. It is particularly at this stage that the possession of at least one meter is of the greatest value in enabling rapid and correct adjustments to be made and possibly in preventing damage to one or more of the valves. For even in the hands of the most skilful constructor it is possible for an error to occur in the wiring, or a short-circuit somewhere in the set—no one is infallible. Without the use of a meter it is possible that the fault would only be found at considerable cost.

Faulty components at times cause a deal of trouble, and with the aid of a suitable meter many can be tested before being built into the set. What is more distress-

It is essential to be able to make simple measurements and tests on a receiver before being certain that it is being operated under proper conditions. Quite an inexpensive instrument is capable of imparting to the skilful owner much valuable information.

Many Uses of an Inexpensive Meter

By S. O. PEARSON, B.Sc., A.M.I.E.E.

ing than to discover a faulty component in a more or less inaccessible part of a completed receiver?

Finally, there is the question of maintaining a receiving set in good working order, and here again the possession of a meter is of the greatest value, whether the set be a home-constructed or bought one. There comes a time when the performance of the receiver shows signs of deteriorating and the trouble must either be found by the owner or the set be sent away to an "expert." One need not dwell on which will be the less costly procedure! If it is a battery set maybe the H.T. battery is running low, maybe not—a meter would tell. Perhaps one of the valves is losing its emission—a meter would show which, and the faulty valve could be replaced accordingly. If the receiver were sent away to be serviced it is quite likely that a complete set of new valves would be recommended, and the owner would have no means of disputing the soundness of the advice. It is very commonly argued by the servicing agent that if one valve is deteriorating the remainder will follow very shortly, but this is by no means the case.

From all points of view the acquisition of at least one reliable meter is sound economy.

The Best Type of Instrument

In view of the foregoing remarks a brief survey is given below of the most suitable meter or meters to procure and the most useful applications. Without doubt the most serviceable instrument, if only one is to be purchased, is one with both milliamperage and voltage ranges, preferably of the moving-coil type. Miniature moving-iron instruments, especially of the polarised type (that is, with definite positive and negative terminals), are, however,

quite suitable, though usually not quite so accurate as the moving-coil type; and moving-iron voltmeters take a comparatively heavy current. The actual instrument chosen must, of course, depend on the depth of the purchaser's pocket, but it should be realised that even a cheap meter costing only a few shillings is most useful and enables a great many tests to be made. After all, the price of a meter is only a fraction of the cost of the receiver itself, and will without question pay for the outlay in a comparatively short time. Of course, the best policy is to buy the best meter one can afford.

The question of the most suitable ranges to choose for both milliamperes and volts depends to a large extent on the type of the receiver; for instance, whether it be battery or mains operated. The milliamperage range should be a little greater than the anode current of the output valve, and the maximum voltage range must be a little above the H.T. voltage required by the set. Taking as an example a battery set requiring 100 volts H.T. and consuming normally 15 to 20 milliamperes, a suitable meter would have a voltage range of 120 and a current range of 24 milliamperes. (The combination of 120 volts and 24 milliamperes is a practical one because 24 is a multiple of 120, so enabling the same scale divisions to be used for both ranges.) A low-voltage range, say, up to 12 volts, would be of great value for measuring filament voltages, low-tension battery and grid bias battery voltages. This would be in addition to the 120-volt range.

Naturally, a useful arrangement is to have a separate voltmeter and ammeter, each with two or more ranges. In purchasing a voltmeter, choose where possible an instrument with the highest resistance in ohms per volt. A voltmeter with a resistance of 100 ohms per volt would take a current of one-hundredth of an ampere

Simple Measurements on Receivers and Components—

or 10 milliamperes with full scale deflection on all ranges. Voltmeters with lower resistance than this take more current and in many circumstances render satisfactory voltage measurements difficult.

Readers with a working knowledge of Ohm's law and a little skill in the winding of resistances will agree that a single sensitive or low-reading milliammeter can be made to operate over various current and voltage ranges by using it in conjunction with different parallel (shunt) or series resistances respectively. Instructions for extending the ranges of such an instrument were given in *The Wireless World* of January 29th, 1930. It should be realised that the actual movement of the instrument is identically the same for a voltmeter as for a milliammeter—it is only the equivalent resistance of the combination and its method of connection to the circuit that determines its function.

Testing of Components

Although good components can be relied upon to conform to the makers' rating within a fair degree of accuracy, it is, nevertheless, advisable to check some of the more important ones where facilities permit and where the test is practicable with the milliammeter or voltmeter available.

One of the most useful applications of a meter is the checking of individual components by simple tests before inclusion in a set under construction, or of suspect components in a set which has failed to give satisfactory results. For instance, simple tests can be made for continuity of circuit through resistances, coils, and transformer windings. It is only necessary to connect a meter in series with the resistance or coil under test and apply an appropriate voltage to the ends of the circuit so formed. If current flows there is no break in the circuit.

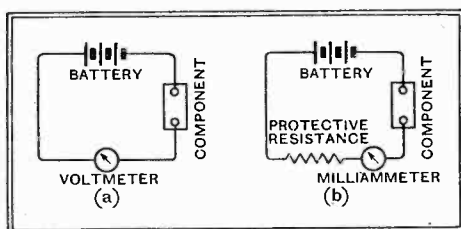

Fig. 1.—Simple test for continuity of circuit through a resistance or other component. A voltmeter should be used for preference as at (a), but a milliammeter may be employed if a safety resistance is included as at (b).

It is most strongly advised to use a voltmeter for this purpose to guard against the flow of excessive current when the component being tested has low resistance—a voltmeter has high resistance and cannot be damaged if the voltage of the testing battery used is not greater than the range of the instrument. The circuit arrangement is shown in Fig. 1 (a). If a milliammeter is used, an extra resistance of a few thousand ohms must be connected in series, as shown in Fig. 1 (b) to limit the

current to a safe value. In the case of very high resistances, such as grid leaks, the current may be too small to be indicated at all, even though the circuit is continuous, and this particular test fails.

Condensers may be tested in a similar way, but as a good condenser has no conducting circuit through it, the conditions are reversed, and zero reading on the instrument scale shows that there is no short circuit in the condenser, and that the insulation between the plates may be satisfactory. But this test gives no proof that one set of plates may not be entirely disconnected from its corresponding terminal. With large capacity condensers, however, such as those employed for smoothing and decoupling, there is a very simple method of finding out if the internal connections are in order. On first closing the circuit there should be a preliminary deflection or kick of the meter needle due to the momentary charging current. If a continuous deflection remains after the initial kick, either the insulation is faulty or there is an internal short circuit. As before, a voltmeter should be used if possible or a milliammeter, safeguarded by a protective series resistance, could be employed.

Variable air condensers can be tested for internal short circuit in the same way; the rotor should be turned through the full range whilst the meter pointer is watched. Any sudden deflection shows that the rotor blades are touching those of the stator, or a particle of metal dust may be lodged between them.

To test the insulation between the primary and secondary windings of a transformer, or between each winding and the core, the procedure is the same as for a condenser.

Measurement of Resistance

The direct measurement of the value of a resistance is not quite so simple and straightforward as Ohm's law would appear to indicate, but as it is of such great advantage to be able to measure a doubtful resistance at times, an example of simple measurement is given here with explanations of the special precautions to be taken.

Ohm's law tells us that the current passed by a resistance is equal to the applied voltage divided by the resistance in ohms. The voltage is the driving force or electrical pressure, and the current is the resulting flow of electrons. If a resistance of R ohms is connected across a battery whose terminal voltage is E, the current flowing will be E/R amperes. But if a milliammeter is included in series with the resistance, as in Fig. 2 (a), to measure the current, the latter will be less than E/R amperes, because the milliammeter itself possesses resistance. If x is the resistance of the milliammeter in ohms, the total resistance across the battery is $R+x$ ohms, and it is this value which is given by the ratio of volts to amperes. Obviously, then, the milliammeter resistance must be known before a test of this nature can be made, unless, of course, the

milliammeter resistance is negligibly small compared with the resistance to be measured, in which case it can be ignored. It is not a very simple matter to determine the resistance of the milliammeter if no other instruments are available, but very often the resistance is given by the makers or would be furnished on request.

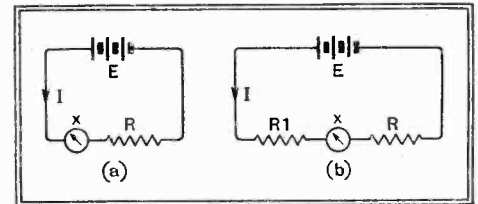

Fig. 2.—Measurement of resistance with a milliammeter and a battery of known voltage E. The circuit is shown at (a). The resistance of the milliammeter x must be allowed for. To guard against a possible short circuit in the resistance R a safety resistance R1 should be inserted temporarily as shown at (b) and explained in the text.

With the aid of a battery of known voltage and a milliammeter of known resistance, it is possible to check resistances over quite a wide range of values. A single accumulator cell gives very nearly 2 volts (except immediately after charging), and so, if an accumulator of several cells is available, several testing voltages are ready to hand. Suppose that one has a milliammeter reading up to a maximum of 24 milliamperes, and that its resistance is 15 ohms, and suppose, further, that it is desired to check a resistance rated at 250 ohms. A convenient current for measurement would be of the order of 20 milliamperes, or 0.02 ampere, and the voltage necessary to drive this current through 250 ohms would be, by Ohm's law, $0.02 \times 250 = 5$ volts. So one would use a 4-volt accumulator in the circuit of Fig. 2 (a). Suppose that the current is found to be 14.5 milliamperes with 4 volts applied; then the total resistance is $4 \div 0.0145 = 276$ ohms. Deducting the 15 ohms resistance of the meter gives 261 ohms for the component under test.

A Wise Precaution

It should always be remembered that a milliammeter is a vulnerable instrument and very easily damaged by an excess of current. Consequently, every precaution must be taken to prevent an accidental jar. If, for instance, the resistance R of Fig. 2 (a) happened to be short-circuited, the milliammeter would be ruined. A safety resistance R1 of the same order of magnitude as R could be included temporarily as at (b) in Fig. 2. If the current rises considerably when the terminals of R are bridged over with a piece of wire, all is in order, and the safety resistance may be taken out of circuit prior to making the actual measurement.

* * *

In a second part of this article an account will be given of simple tests and measurements which can be made on a completed receiver, and how a meter can be used to give a visual indication of the performance of a receiver.

NEWS of the WEEK

Current Events in Brief Review

All Eyes on Glasgow

GLASGOW, where the Scottish Radio Exhibition opens tomorrow in the Kelvin Hall, has been a stronghold of wireless since the days when 5SC (of blessed memory!) first transmitted the voice of the then British Broadcasting Company.

Of recent shows in Glasgow the most notable was that held last year in the same hall under the auspices of the *Glasgow Weekly Herald*. This year's Show—the first to be sponsored by the Radio Manufacturers' Association—will be a close replica, if on a smaller scale, of the Olympia Exhibition. With nearly eighty stands and a radio ballroom, the Glasgow Show bids fair to make new records both in attendance and business transacted.

A complete guide, with plan, appears on page 202.

The Prince of Wales

ROYAL recognition of wireless has been very marked in recent years, and the Prince of Wales will be carrying on the tradition when he honours the Radio Manufacturers' Association by attending the Annual Dinner in November under the chairmanship of Mr. W. W. Burnham.

This will be the first time that His Royal Highness has been present at this annual dinner.

All in 135 Minutes

MR. J. HUNTER, of Blackheath, London, whose station G2ZQ is one of the best-known in Europe, has put up yet another amateur transmitting record. In two and a quarter hours on one evening recently, he communicated with amateurs in New Zealand, Palestine, Argentine, French North Africa, the United States and England using the 20-metre band.

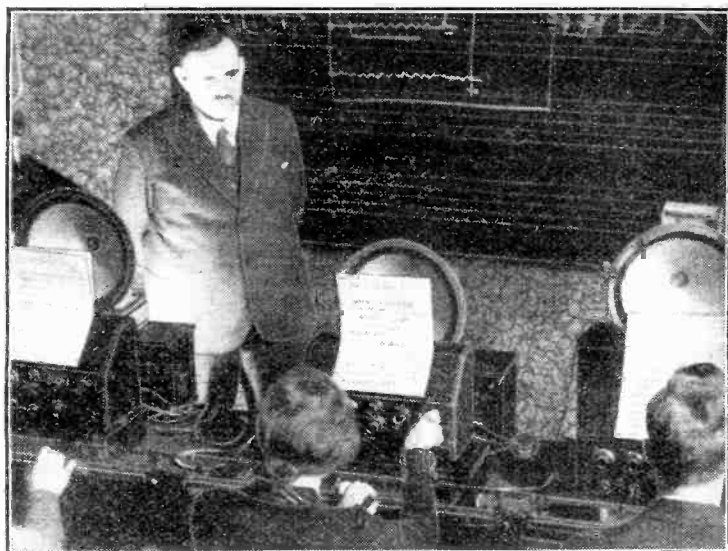

ELECTRICAL MUSIC. So high an authority as the Berlin State Academy of Music has now recognised the possibilities of the thermionic valve as a musical instrument. The photograph shows a Trautonium class under the direction of the inventor, Dr. Trautwein.

Future of Radio Paris

AS a sequel to the purchase of Radio Paris by the State, members of the station staff have received formal notice that their engagements will expire without renewal from December 3rd next. It is expected, however, that the whole of the staff will be re-engaged.

Luxembourg Stands Firm

RADIO LUXEMBOURG, it seems, intends to stand by its guns and continue transmissions on the 1,190-metre wavelength, despite the decrees of the International Broadcasting Union. According to a recent visitor, the management contend that it is impossible for an "international" station to work on an exclusive wave of 240 metres. It is hoped that this will be recognised at the forthcoming Amsterdam Conference of the Union.

The Luxembourg transmitter is open to inspection by visitors, who are enabled to see the studios through soundproof windows.

Programmes on Tap

THE peril attaching to the tapping of wires belonging to a wireless relay company was brought home to Mrs. Stanley, of Moorthorpe (Yorks.), when she was fined £1 last week for having fraudulently abstracted a quantity of electricity. Mr. E. H. Moorhouse, prosecuting on behalf of Economic Radio, Ltd., explained how, on July 21st, following much interference, it was found that Mrs. Stanley had tapped the wires and attached a loud speaker, with the result that some fifty or sixty subscribers on the far side of her house were cut off. The current consumed by Mrs. Stanley was only assessed at 1s., but the tracing and making good of the damage was 15s.

Kettering Radio Show

THE first annual radio exhibition at Kettering is to be held on September 14th, 15th and 16th in the Co-operative Central Hall under the auspices of the Kettering Radio and Physical Society.

Musical Murder

INVESTIGATION into a recent Paris murder revealed that a loud speaker was switched on in the flat in which the two victims, a mother and her son, were put to death. French detectives consider that the murderer had tuned in before making his attack in order to stifle any compromising sounds.

Lectures on Wireless

A COURSE of twelve lectures on "Wireless Science" are to be given at Morley College, 61, Westminster Bridge Road, London, S.E.1, by Mr. H. S. Ryland. The lectures will be given on Friday evenings at 7.30, beginning on September 22nd. Full particulars regarding fees may be obtained on application to the Secretary.

French Radio Revelations?

IMPORTANT revelations concerning the immediate future of French broadcasting and the development of the high-power scheme are expected when M. Laurent-Eynac, the Postmaster-General, speaks at the Paris Wireless Show Banquet. The Show, which is international in scope, will be held in the Grand Palais, Paris, from September 6th to September 17th. In addition to exhibits by practically the entire French radio industry, the "Salon" will contain a special section devoted to anti-static devices, the use of wireless, in aviation, marine and Colonial services, and practical demonstrations of the manufacture of gramophone records.

A wave of wireless enthusiasm seems to be sweeping France, due to the development of the Ferrié scheme and the realisation that the State is going ahead with the development of broadcasting.

Pitch Pine for Radio Masts

THE increasing use of wood in the construction of wireless masts has greatly encouraged the timber trade. "The Timber Trades Journal" refers, with gratification, to the new German wireless tower erected at Rothsurven, near Breslau, which is built entirely of wood and is claimed to be the tallest wooden structure in the world. Its height is 460ft.

It is stated that German engineers combed the world for the best structural material available, and ultimately chose pitch pine, which is said to excel all other woods in homogeneous strength properties, and provides large dimensions relatively free from knots and defects. Its high content of resin acts as a natural preservative; in addition, pitch pine is not apt to check and split, and its shrinkage factor is very low.



THE BERLIN SHOW. Changed political conditions have made their impression on the famous German radio exhibition, which has just been held under the shadow of the Radio Tower, or Funkturm, in Berlin.

5-metre Tests in London

TRANSMISSIONS on 42.2 metres (7,097 k.c.) and 5 metres (5,600 k.c.) are being carried out to-day (Friday) and on Sunday next by Dr. C. G. Lemon (G2GL) at 72a, North End Road, W.14. The schedule is as follows:—*Friday*: 5 metres, 10.45 p.m. to 11 p.m.; 42.2 metres, 11 p.m. to 11.15 p.m. *Sunday*: 42.2 metres, 10.30 a.m. to 11 a.m., 11.30 a.m. to 12 noon; 5 metres, 11 a.m. to 11.30 a.m. Similar schedules will be followed throughout next week.

The Winning District

DISTRICT 15 of the Radio Society of Great Britain secured first place in the National Field Day organised recently by the Society, in which portable transmitters and receivers were operated by eighteen groups of amateurs from the R.S.G.B.'s nineteen administrative districts.

District 15 covers West London and Middlesex, and during the Field Day the call signs G6VN and G6YK were used, on the 160 and 80 metres, and on 40 and 20 metres bands respectively. A total of 364 points was obtained, with 64 contacts with other amateurs.

Dr. Koon Speaks

"EVEN the rubbing of a careless finger over a half-day's growth of beard may completely confuse a radio-audience," writes Dr. Cline M. Koon in his booklet, "The Art of Teaching by Radio," just published by the U.S. Office of Education. Dr. Koon advises the broadcaster to avoid heavy breathing, keeping time with his feet, clearing his throat or clicking his finger-nails. The announcer and operator, too, should play their part by making the speaker comfortable and at ease, allowing him to sit and roll up his shirt-sleeves.

It is very important that the broadcaster should assume a friendly, respectful attitude.

Practical HINTS and TIPS

IT is not difficult to see that the continuity and general condition of an earth connection cannot be checked by the methods ordinarily adopted in testing other circuits. A fairly good indication that something is wrong is often afforded

Testing the "Earth"

by the fact that a general decline in signal strength is accompanied by a change in tuning, more capacity being needed to bring the aerial circuit into resonance with a given wavelength. But this latter effect is likely to pass unnoticed in a modern gang-tuned receiver.

To ascertain definitely whether the earth lead is broken, it is usual to make a test for continuity between the normal earth connection and a second extemporised "earth"; if all is well there should be negligible resistance between these two points. But the converse does not of necessity hold true; possibly the temporary and unknown "test earth" may itself be of high resistance.

A reader, who evidently believes in taking no unnecessary chances, describes a method of testing the earth connection for which he has made provision in his own installation. The details will be obvious from a consideration of Fig. 1, from which it will be seen that, in addition to the usual connection to the buried earth plate, a second lead, solely for testing purposes, has been soldered to it. The end of this lead, when not in use, is coiled up and concealed in a tin buried just below the surface of the ground.

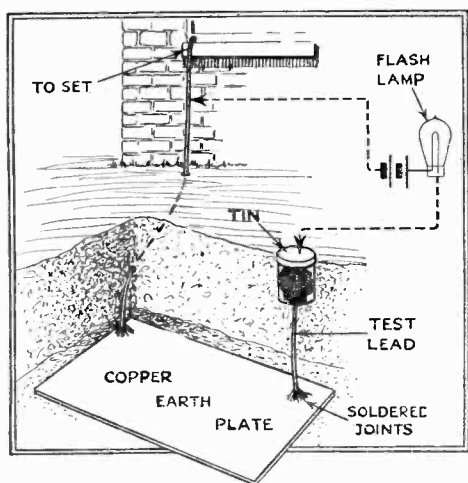

Fig. 1.—Perhaps over-cautious, but— How to make provision for testing a buried earth connection.

Although it must be admitted that precautions of this nature are hardly necessary in most cases, the provision of a testing lead in this manner involves very little extra trouble, and may save a lot of unnecessary work in the future, especially if the earth plate be deeply buried.

AIDS TO BETTER RECEPTION

ALTHOUGH modern D.C. valves work at a higher voltage and a considerably lower current than their prototypes, it is generally necessary to dissipate a considerable wattage in the main voltage-absorbing resistance, which is wired in series with the heaters.

D.C. Set Precautions

This energy is, of course, finally dissipated in the form of heat, and so an appreciable temperature rise may be expected.

Instances have recently come to light where heat generated in this way has adversely affected paper-dielectric by-pass or smoothing condensers by melting the sealing compounds generally used in the manufacture of these components. It is accordingly wise to make sure that the condensers are mounted in a cool position, and certainly not in the immediate vicinity of the main resistance. In any case, provision for ventilation of the complete set should be made.

IT was recently pointed out that many liberties may be taken with regard to the layout of the L.F. section of a receiver. Unlike the H.F. amplifier, it is but seldom that the result of doing so will be to cause instability or some other manifestation of undesirable interaction.

Transformer Interaction

But, in view of the fact that the L.F. amplifier and power supply equipment are often designed nowadays as a single self-contained unit, it is perhaps as well to point out that a common—perhaps the most common—cause of mains hum is interaction between power and L.F. transformers. Fortunately it is seldom difficult to overcome this trouble by an experimental alteration in the relative positions of these components.

IT is rather a pity that we are all prone to expect rather too much from new developments. Take Class "B" amplification; it is proving a real boon to those who are forced to use batteries for H.T. supply, but for mains use in ordinary sets

For Batteries Only

it presents special problems, and, generally speaking, has few attractions. In spite of this there seems to be a tendency, among those who have mains available, to swing over to the new system.

In doing this they are certainly making a mistake; the older and more conventional circuits, with mains-driven valves and a liberal supply of anode current, may be expected to yield better results, and to involve fewer complications and less cost.

IN a recently published reply to a reader's query, it was pointed out that the system of automatic volume control employed in the original A.C. Monodial is impracticable for the D.C. version of the same set, due to the fact that no surplus H.T. voltage is available for the A.V.C. valve.

A.V.C. for the D.C. Monodial

It will be clear, however, that this objection does not apply when a user of the D.C. set is willing to employ an H.T. battery for the controlling valve. Although there may be a natural reluctance to use batteries in an otherwise "all mains" set, the plan is nevertheless quite a practical one, and the extra valve may be wired as shown in Fig. 2.

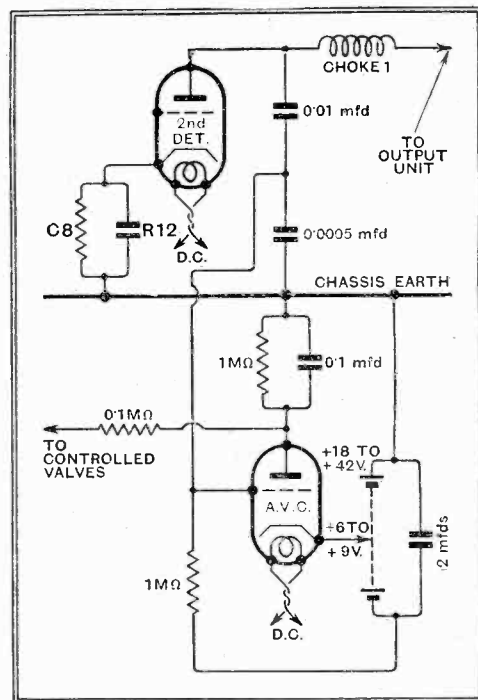
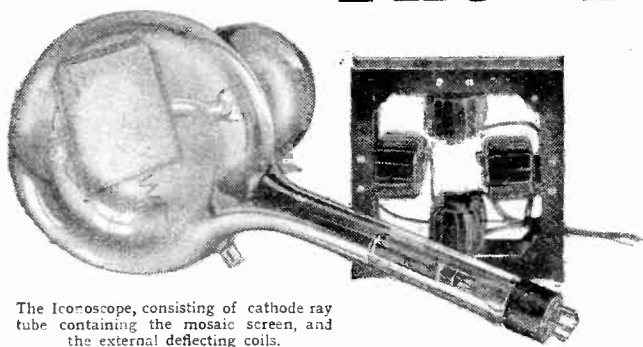

Fig. 2.—The addition of an A.V.C. valve to the D.C. Monodial.

It is opportune to point out that, although a relatively high anode voltage is needed for the A.V.C. valve when full control has to be maintained in the neighbourhood of a powerful station, no such necessity arises in "wirelessly" remote localities where overwhelmingly strong signals are not to be expected. Where the input from the aerial cannot reach a high value, quite a small anode voltage suffices, and, according to a user of this system, a measure of control is still obtainable if the H.T. voltage be reduced to as little as 18 volts. The extent of delay in the action of the A.V.C. system is easily controlled by varying the cathode tapping on the H.T. battery; this determines, of course, the working bias of the grid. Incidentally, a Marconi or Osram D.H. valve has been found suitable for A.V.C.

The ICONOSCOPE



The Iconoscope, consisting of cathode ray tube containing the mosaic screen, and the external deflecting coils.

America's Latest Television Favourite

AN interesting step towards practical television was announced at a recent convention held in Chicago by the Institute of Radio Engineers; the "Iconoscope" of Vladimir Zworykin relating to the use of a cathode ray tube in place of a scanning disc. The Iconoscope is claimed to be several thousand times as efficient as the scanning disc even when it is working far below its theoretical maximum efficiency. It makes it possible to transmit twenty pictures, or more, per second, with a detail corresponding to as many as 250 lines per square inch. The most important feature of the device, however, is its power of imitating the human eye in regarding a picture continuously and in possessing a certain degree of retentivity. It replaces mechanical scanning and several stages of amplification; it is entirely electrical and has no moving parts.

The Iconoscope consists of two devices—a photoelectric mosaic on which the picture is focused by a lens system, and a cathode ray gun which fires at this screen a stream of electron projectiles. The elements of the device are shown in the drawing of Fig. 1. The signal plate upon which the picture is focused may be about 4×5 inches in dimensions and on its surface are millions of small photocells, each consisting of a minute silver globule sensitised by caesium. These minute photocells like a mosaic are deposited on an insulating plate, such as a thin sheet of mica, and the back of this plate is made conductive by a metal coating. Since both the photocell and the metal coating are conductors, and they are insulated from one another by mica, each individual photocell forms a small condenser with the metal plate. This capacity amounts to several hundred micro-microfarads per square centimetre, and the sensitivity of the photocells is equal to that of the modern caesium oxide type cells.

How the Image is Translated

Now, suppose a scene, say, of a well-lighted outdoor landscape is focused upon this plate. Since there are varying degrees of light and shade, there are varying currents flowing from the individual photocells. These currents charge the condensers associated with the photocells

according to the flow of current, and the picture is thus translated into an electrostatic screen made up of many thousand electrical charges, each condenser being charged according to the intensity of the light falling upon its photocell.

Within the same glass bulb as the mosaic is the electron gun which throws a beam of electrons at this screen and which is made to sweep across the screen horizontally and vertically by means of deflecting coils, as in an ordinary cathode ray tube. Whenever an electron hits a photocell it neutralises part of the charge on the associated condenser. This discharge current is picked up, amplified, and transmitted to the receiving cathode ray beam which is moving across a fluorescent screen in synchronism with the scanning beam. The varying discharge currents modulate this receiving beam and hence the screen at the receiver.

Increase in Light Values

The Iconoscope apparently solves one of the worst problems of television, that of getting sufficient light from each point so that the resulting photocurrent can be effectively amplified for use at the receiver. In his description Dr. Zworykin states that a desirable picture would involve some 70,000 picture elements. If there are twenty pictures per second, the time of transmission of each element would be 1/1,400,000 of a second. This is unimportant provided that the light intensity is sufficient to actuate the photocell in this small time. This is where the difficulty lies, however, for the photocell delivers a current depending upon the product of the light intensity and the time during which this light acts. If the time be decreased, the current is reduced. With a scanning disc the current falls as the square of the number of picture elements because the time decreases for any increase in the number of holes. It has been virtually impossible, therefore, to televise outdoor scenes because of the difficulty of getting enough light.

Again following Dr. Zworykin's reasoning, suppose it be desired to televise this outdoor scene. A camera with a lens working at a speed of F 4.5 would focus on a plate about 1/10 lumen. Now, if a scanning disc were used to take this picture apart and transmit it into a photo-

cell of average sensitivity, say, 10 micro-amperes per lumen, a single picture element would produce a current of the order of 1.43×10^{-11} ampere. In the time available this would produce a charge of 1×10^{-17} coulomb, corresponding to about 63 electrons. All this means that tremendous amplification is necessary if an outdoor scene is to be transmitted successfully.

The trouble with the scanning disc system of taking the picture apart is that the light from a single point of the scene affects the photocell for such a short space of time. If the photocell could see all of the picture all of the time, as is true of the human eye, the efficiency or light gathering power compared to that of a disc scanner would increase as the number of picture elements. Thus with 70,000 elements the Iconoscope, which accomplishes this seeing-all-at-once, is theoretically 70,000 times as efficient as the scanning disc and hence the amplification may be reduced to a vast degree. Actually the efficiency of the Zworykin device does not reach this figure, but it is stated to be several thousand times as good as the scanning disc.

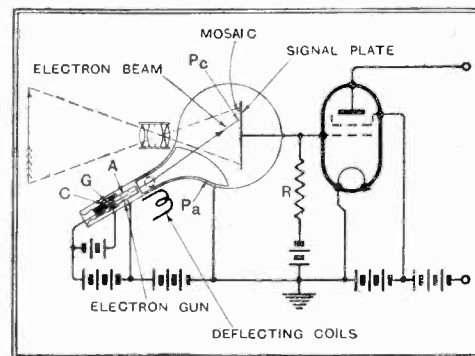

Fig. 1.—Elements of the Iconoscope device.

The mosaic of photocells has the entire picture focused upon it, resulting in the continuous emission of electrons according to the degree of light and shade in the picture. Once in each repetition of the picture the charge on the condenser acquired by each element of the mosaic is released by the cathode ray beam.

The fact that the transmitting screen is 4×5 inches in size is no indication that the receiving screen is limited to this size. In fact, Zworykin claims methods of projecting the picture from the fluorescent end of the cathode ray tube upon a larger external screen by lenses and mirrors.

Dr. Zworykin's paper, when available for publication, will contain many most interesting facts with reference to the composition of the mosaic, the size of the cathode ray beam when it hits the screen, the detail secured, etc. In the opinion of well-known American engineers it marks another landmark in the history of television.

New Class "B" Output Valve

Operating Data and Curves for the Marconi and Osram B.21

FROM the point of view of the battery user, Class "B" amplification is one of the most important of recent developments, and it is interesting to see that the Marconiphone and Osram G.E.C. Class "B" valve departs from normal practice in several particulars. The valve consists of the usual two triodes in a single glass envelope, but these triodes have com-

Of even more importance, however, is the reduction in the tendency towards the generation of parasitic oscillations. These are often found in the circuit comprising the leakage inductance of the transformer and the stray capacities, and occur in that valve circuit which is for the moment idle. Due to the lower amplification factor of the B.21 there is not this same tendency towards parasitic oscillation, and the makers claim that it is consequently easier to obtain good quality reproduction. The point is well brought out by the oscillograms of Fig. 1, which are both taken for an output of 250 milliwatts. The upper photo shows the waveform of the output of a zero-bias type Class "B" valve when fed with a sine wave input. It will be seen that a fairly strong high-frequency oscillation is superimposed on the main output. The lower oscillogram refers to the B.21 valve, and it will be obvious that, although there is still a high-frequency oscillation present, it is much smaller in amplitude, and the reproduction obtainable is correspondingly improved.

Constructionally, the bulb of the valve is unusually shaped, and the upper narrow portion grips a mica bridge holding the electrode assembly, and so increases the rigidity. Instead of a single fine grid for each triode, two rather coarse-mesh concentric grids are used, thus giving an unusually robust construction. It is, of course, fitted to the standard 7-pin base.

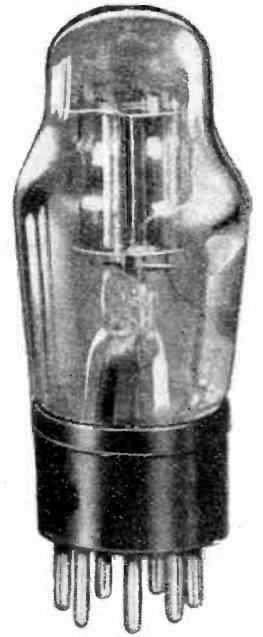

To sum up, it will thus be seen that the valve differs radically from other types, and, although it consists actually of two valves in a single glass envelope, its filaments consume no more than 0.2 ampere at 2 volts. The input impedance is high, some 36,000 ohms, resulting in a reduced tendency towards parasitic oscillation, and the valve needs negative grid bias.

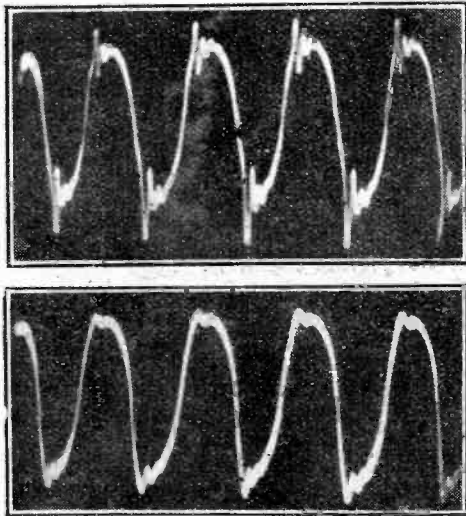

Fig. 1.—The upper oscillogram shows the output of a zero-bias Class "B" valve, and the lower that of the B.21.

paratively low amplification factors. At zero grid bias, therefore, the anode current is quite high, and the anode current cut-off point is not reached until some 4 to 6 volts negative bias is applied to the grids. The valve, therefore, is normally biased by this amount, and this leads to several important points.

First, grid current does not flow for a small signal input, with the result that the input impedance is high, and the system is more like a triode Q.P.P. arrangement than true Class "B." Secondly, with a large input grid current does not flow throughout the whole cycle of the input voltage, but only during a portion of it. The input impedance, therefore, is much higher than that of the zero-bias type of valve, and less power is required to operate it.

One important result of this lies in the possibility of reducing the ratio of the driver transformer, in some cases to a 1:1 ratio. Under certain conditions, moreover, it even becomes practicable to employ a step-up ratio. There is, therefore, an appreciable gain in amplification and a smaller signal input is necessary at the grid of the driver for full output.

Operating Conditions

Three alternative operating conditions are recommended by the makers. The first is for maximum economy, and with 120 volts anode supply a bias of $4\frac{1}{2}$ volts is needed. The load impedance must be 18,000 ohms, and the driver transformer can have a step-down ratio of 1.5:1 from the L.21 driver valve. The standing anode current of the output valve is then 1.7 mA. and the output is 750 milliwatts. *Osram 900 mw*

The moderate economy condition leads to an output of 800 milliwatts for the same anode voltage, and the bias can be only 3 volts. The load now becomes 12,000 ohms and the driver transformer can be between 1.5:1 step-down and 1:1 ratio.

The condition for maximum output, however, necessitates an L.P.2 driver and an 8,000 ohm load on the Class "B" valve, the standing anode current of which increases to 3.5 mA. The output is 1,200 milliwatts with a 120 volts H.T. supply, and 2,000 milliwatts with 150 volts. In this latter case $4\frac{1}{2}$ volts bias is needed, and the standing current becomes 4 mA.

Considerable latitude in the operating conditions is thus permissible.

As is usual in Class "B" working, it is advisable to connect a 0.005 mfd. condenser across each half of the output transformer primary. When using the lower values of load impedance a somewhat higher capacity is better.

Fig. 2 shows the characteristics of the valve, and Fig. 3 the grid current curves.

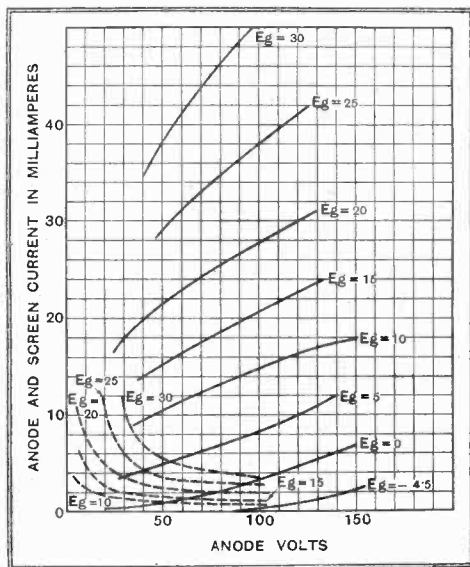

Fig. 2.—Anode volts-anode current curves of the B.21.

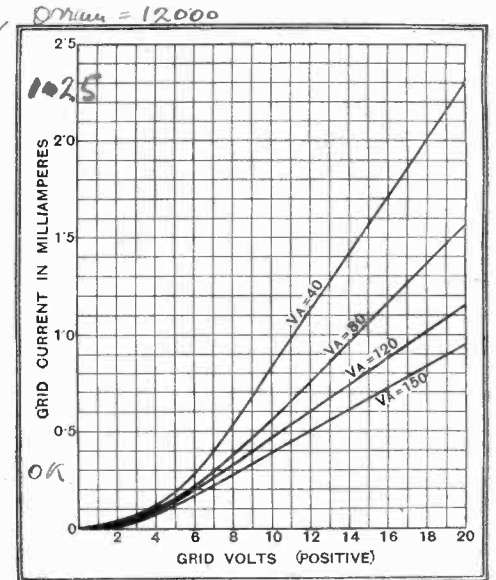

Fig. 3.—Grid volts-grid current curves of the B.21.

New Catalogues Received

Wright & Weaire, Ltd., 740, High Road, Tottenham, London, N.17.—25-page booklet describing "Wearite" components well illustrated and containing many useful theoretical diagrams and explanatory drawings of coil assemblies. The price is 3d.

A. F. Bulgin & Co., Ltd., Abbey Road, Barking.—Of the 80 pages contained in this well-illustrated and informative catalogue 25 are devoted to a Technical Manual dealing with the many applications of Bulgin components.

F. C. Healyberd & Co., 10, Finsbury Street, London, E.C.2.—1934 catalogue of Radio Mains Equipment; a 36-page booklet dealing with H.T. units, battery chargers and mains transformers. Twelve pages are devoted to eliminator kits, a theoretical circuit diagram being given for each model. The price is 3d. post free.

Binaural Reception

An Acoustic Illusion Telephonically Achieved

By HARVEY FLETCHER

Acoustical Research Director
Bell Telephone Laboratories

ABILITY to locate sounds is mainly due to interaction between the two ears. Stopping up one ear renders location of sounds almost impossible. Interesting experiments with telephone links to demonstrate this facility are described in this article.



DURING the winter and spring of last year a strange figure inhabited the American Academy of Music in Philadelphia. Looking him full in the face, one met unblinking eyes and a slight smile, fixed and unfading; and this evidence of inhumanity was confirmed by looking at him in profile, for just in front of his ears microphones were set into his cheekbones. Thus Oscar, a tailor's dummy, though less than human in appearance, was given one capacity that was more than human; that of instantly communicating to others exactly what he heard, exactly as he heard it. To listen through the receivers connected to Oscar's microphones was to put oneself in Oscar's place. This capacity of Oscar's gave him an important position in the tests of musical reproduction conducted by the Bell Laboratories in cooperation with Dr. Leopold Stokowski and the Philadelphia Symphony Orchestra.

Locating Sounds

When one hears a sound one can usually locate approximately its point of origin—its distance and direction. The mechanism by which this location is accomplished is not altogether understood, but the interaction of the two ears seems to have much to do with it, for stopping up one ear destroys the ability almost completely. In listening to an orchestra under the two conditions the difference in effect is quite similar to that between a view seen in full perspective with both eyes and in flat panorama with only one.

It is to be expected that any two sound-apprehending devices could double for the ears. Two microphones, placed the same distance apart as human ears, could be independently connected by two receivers. A person putting the receivers

to his two ears would be acoustically transported to the location of the microphones no matter at what distance from them he might actually be, hearing all sounds as he would if his ears were in the positions of the microphones. Oscar duplicates the conditions of normal hearing as nearly as possible, not only by supporting the microphones the proper distance apart, but by modifying the sound field near them as a human head modifies it near the ears.

In the extent to which they approach the conditions of normal hearing, systems for transmitting sound can be roughly divided into four classes, as represented in Fig. 1. In "monaural" systems, such as the commercial telephone, a single transmitter is connected to a single receiver. "Diotic" systems, in which the transmitter is connected to two receivers, one for each ear, are familiar to those who have used double head telephone receivers. "Mixed" reception is found in the similar use of double receivers to monitor a loud-speaking public address

the two receivers, only a few experimental examples have been built.

From the familiar monaural condition the change to the diotic produces mainly the effect of an increase in the loudness and fullness of the sound, and of a shift of its apparent source to the centre of head. Changing to the mixed condition adds a roughness to the sound, but leaves its loudness and apparent source as they were when reception was diotic. With the final change to the binaural condition the apparent sources of sound move to approximately their proper locations in space, and the apparent reverberation is greatly reduced.

Importance of Frequency Response

To provide for the experiments in Philadelphia, a binaural system which would reproduce speech and music faithfully in all respects, microphones, amplifiers and receivers of the highest quality were used in the two channels, transmitting extremely wide ranges of frequency and volume. Since the response of a receiver depends upon the person's ear upon which it is placed, perfect reproduction requires a different equalisation for each person. In these experiments, however, only a single equaliser was used, which was an average for a group of listeners. By its use the frequency characteristics of the system were corrected, so that all observers agreed that the reproduction was exceptionally faithful.

Striking evidence of the naturalness which can be secured with such a binaural system was obtained at several formal demonstrations in Philadelphia. When the guests had put to their ears the receivers connected to Oscar, who was in another room, someone would say confidentially in Oscar's ear, "Please move over." A surprisingly large number of the guests would start to obey the command before realising that it came from

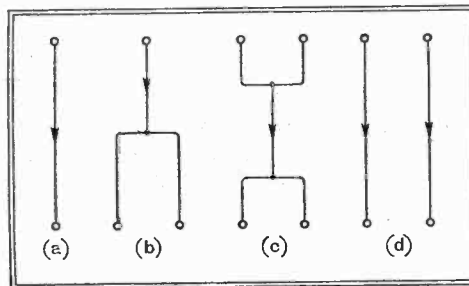

Fig. 1.—Systems of transmission can be roughly divided into four classes: monaural (a), diotic (b), mixed (c), and binaural (d).

system, in which two microphones are used to pick up the programme and their outputs are mixed. Of "binaural" systems, in which the outputs of two microphones are separately conducted to

Binaural Reception—

the receivers. Afterwards someone would whisper in first one and then the other of Oscar's ears, and would tear paper, jingle keys or thump a tambourine to illustrate the fidelity of the system to sounds of high frequency. Finally Oscar would be brought out and set in the midst of the audience, so that they could compare for themselves the direct with the transmitted sounds.

Experiments showed that the advantage of using Oscar, instead of two microphones less dramatically mounted, was confined to cases in which the sounds originated quite near the microphones. For tests of the reproduction of music, therefore, two microphones were hung from a bar. It was found that, when the localisation effect of the system is disregarded, the best place for the microphones is relatively near the orchestra, where the tones are brilliant because absorption has not diminished the high frequency components as it has by the time the sounds reach remote parts of the hall. The localisation is such, however, that observers sitting at the rear of the hall, where they can see the orchestra, prefer to have the microphones near them, even at the expense of tonal brilliance, for otherwise they find themselves discomforted by being acoustically in one place and visually in another.

This effect has even been noticed by observers in another room, where a screen placed the source of sound at a certain apparent visual distance.

In comparisons of binaural with loud speaker reproduction, even the inconvenience of wearing head receivers does not prevent most observers from preferring the binaural system. In an attempt to rate the worth of the binaural system, observers were asked to note their preference between monaural reproduction of the full frequency range and binaural reproduction of various limited frequency ranges. Even when all frequencies over about 2,800 cycles per second were suppressed in the binaural system more than a third of the observers preferred it.

To give a wider public the unique experience of being put in the other man's place by a trick of the ear, a binaural system has been set up. In this Oscar II will appear in a glass booth somewhat similar to that shown in the title picture, and observers who hold to their ears a pair of telephone receivers will feel as if transported to Oscar's position, there to be addressed by his companion. The system will furnish to those who use it dramatic proof that there is no longer any limitation, except expense, to the acoustic fidelity which electrical transmission systems can achieve.

the general mass of people does not know what it does want, and the manufacturers, assuming that what is thought is wanted is a large number of foreign stations, continue to offer sets in which quality of reproduction is subservient to the demand for the reception of distant stations. In the course of my everyday life I come across a very large number of listeners of all classes, and I know of only two people who neglect the reception of B.B.C. programmes entirely for foreign stations; it so happens that both these people are completely devoid of any sort of musical or educational appreciation. Many people wish from time to time, to tune in distant stations for the sake of special programme items, but, with several foreign stations at their present quality and power, quality of reproduction is just as important as when receiving the local B.B.C. transmissions. Radio can give exceedingly good and natural entertainment, but the time must surely come when the public will wake up to the possibilities of the science and then, perhaps, we will have some technical progress in the direction of quality of reproduction.

Quality Should Come First

As much money should be devoted to quality as is now spent on increasing selectivity and sensitivity to make reproduction from a local station really worth listening to, for the cheap set sounds very bad on a good transmission. The consequence of selling large numbers of sets giving distorted reproduction is to drive still more firmly into the public mind the idea that the sounds produced are the kind of sounds that radio is expected to produce. Were this truly the case, there would be every justification for the B.B.C. to spoil the quality of its transmissions to an extent where it would be equal to that of the average commercial set; if such did happen it would be found that the final results were so bad that the radio industry would die out. In case anyone takes exception to this statement, I would like to point out that I did not meet with a single radio-gramophone at the show which was capable of getting the best out of a good gramophone record;

Thoughts on Olympia

By a Critic of Quality

In the Following Article a Wireless Engineer Gives His Personal Impressions of the Show

I SET out to examine the exhibits at the Radio Show from a viewpoint differing from that of the official *Wireless World* reporters, because I am not so concerned with giving a complete description of the various manufacturers' achievements as in indicating what I think are desirable or undesirable trends of development.

I am one of those who have always held very strong views on the necessity of preserving the true function of radio apparatus, namely, to give in the homes of subscribers to the broadcasting service a true and faithful reproduction of what that service offers. This being so it is natural that I should examine the show to see what progress has been made in this direction.

Most manufacturers are of the opinion that the largest amount of money is to be made by selling the largest possible number of sets. Past experience shows this opinion to be a sound one, but, as the largest sales are made by the cheapest articles, it follows that cheapness calls for the sacrifice of excellence, so that we have a state of affairs in which the receiver most suited to the needs of the listener is generally much too expensive for him. The portable set craze of a few years ago was the start of the trouble. At that time sets were not very good no matter what the price paid, but some mis-inspired genius conceived the idea of making still worse sets, but appealed to the public to appreciate the convenience of

portable radio. Tens of thousands of these sets were sold, and I am convinced that 99.9 per cent. of them were never shifted out of the room in which they were first placed; we have the result that performance was spoiled to secure a property that the public did not require or appreciate, and, at the same time, the public taste was so spoiled that a demand for good sets has not yet made itself evident. It is notorious that

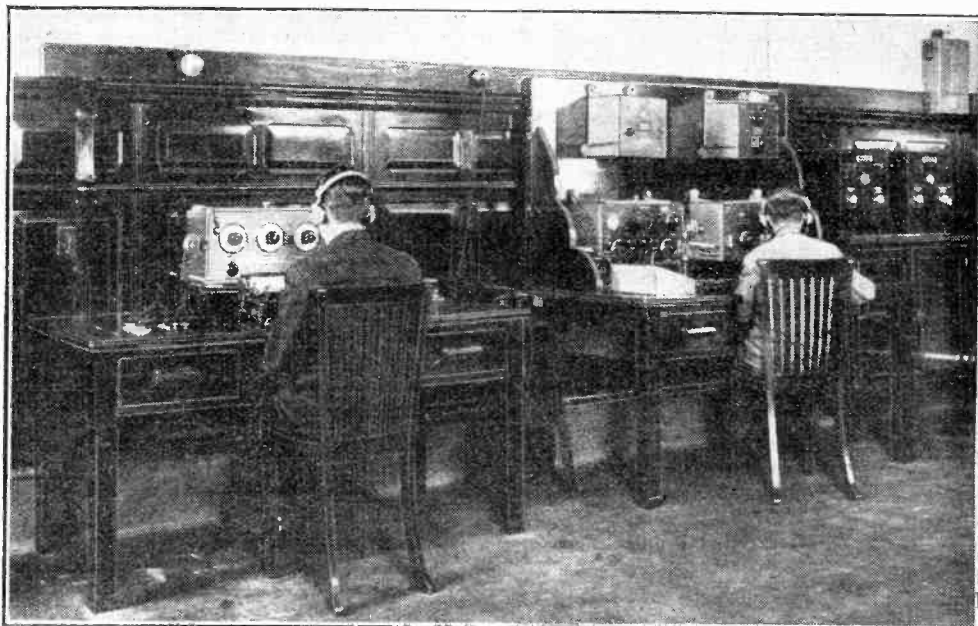

WIRELESS AND THE POLICE. Few police organisations dare forgo the benefits of radio. Here is a scene in the radio receiving room at police headquarters, Rio de Janeiro, which has just been equipped with a Marconi installation.

Thoughts on Olympia -

to do this calls for an exceedingly good amplifier and loud speaker which will do useful work up to far more than 6,000 cycles, although it is a commonplace that records cut off below this figure; I mention the point to show a close connection between the comparative merits of a record going through a good L.F. apparatus, and a good B.B.C. transmission going through a poorly designed set. Present reproduction is obtained in spite of receivers and not owing to their inherent "excellence" of design. With one or two solitary pioneers excepted, we would be in a bad way indeed were it not for a responsible technical press.

The Superhet Stampede.

The superheterodyne principle of reception seems to have become the master rather than the servant of the manufacturer. It can fairly safely be assumed that this journal was responsible for the return of the superhet. to favour, but it does not follow that *The Wireless World* recommended that every manufacturer (with one or two notable exceptions) should go "super mad." This type of receiver is very suitable for the home constructor owing to the ease with which it can be made to work satisfactorily; on the other hand, for equal selectivity and sensitivity, the straight multi-stage set is a very troublesome beast for the amateur. It would seem to be equally troublesome to the professional, who has little excuse, with all his facilities, for rushing to the superheterodyne principle where the straight set, properly designed, would meet the case better.

It should be borne in mind that the manufacturer can and does purchase ready-made ganged coils and condensers for superhets., and almost any schoolboy could finish the design of the set. It takes real brains, however, to design a really good straight receiver, for the usual canned or iron cored coils are not by any means good enough, and possess certain disadvantages which preclude their use in a satisfactory design; the consequence is that the technician has to design "from the ground up," and that, I fancy, is a task beyond the capabilities of many in the industry.

I was interested to find several firms who were making a speciality of building a "limited number of high grade receivers for the connoisseur." In one or two cases there was evidence of real thought and research behind the receivers shown, but a word of warning might not be out of place to those manufacturers contemplating entering this field. In every ten or so listeners there is one man who wants something better than he can find in the ordinary way, and that man is going to choose his special set on performance and nothing else. The inclusion of a conventional set in an elaborate cabinet, and a multiplicity of valves does not make a "high grade set for the connoisseur" although the showy outside may appeal to the bloated plutocrat; most of the real searchers after something good whom I have met have usually been somewhat hard up, so everything should be devoted to the one purpose of giving superlative performance; one manufacturer told me he started with an "exquisite cabinet" and fitted the set in afterwards; the idea is, at any rate, original, but has little else to commend it.

Moving-coil speakers continue to get smaller and cheaper, and some people may say that putting this type of speaker

within the reach of everybody is progress, but I must confess that I do not see how it can be. The function of a loud speaker is to translate into sound what is put into it electrically, and I did not find any manufacturer showing on his stand how this was done with less distortion than heretofore. If the midget set idea is responsible, then the midget set is a menace to the future of broadcasting.

The real novelty merchants this year were the valve makers, and some very interesting and amusing things can be done with the new types now available. The wholesale adoption of A.V.C. has, in most cases, only been made possible by the work done in valve laboratories, so we will give credit here in the proper place. In the space at my disposal I cannot say much about valves, but a point that is not sufficiently realised about Class B amplification is that it is only really useful on substantially constant modulation; the power provided is truly astonishing considering the size of the valves, but it should be remembered that this power is only undistorted when the output stage is going "all out" with the circuit arrangements usually given: most Class B output stages require positive bias. The constantly varying modulation of transmissions carrying music means that, for most of the time, the power stage is under-run and a particularly unpleasant form of distortion is set up which can be very irritating to sensitive ears. Do not, therefore, design your new A.C. set and expect to get from two 5-watt what you would obtain from two 25-watt valves.

Components generally showed a great improvement, both in the elimination of unworthy designs and in the introduction of new features of great use to the home constructor. It can safely be said that component manufacturers are giving better value for money, but it is disappointing to find that the perfect volume control has not yet been invented.

I think the time has come to abolish the scheme of piping through fifth-rate gramophone



CAR RADIO: MILITARY VERSION. A typical scene during the recent manoeuvres in Hampshire, showing a wireless car in action.

phone records for the edification of the public through the medium of speakers on exhibitors' stands. This proves nothing to anyone beyond the fact that the B.B.C. is up against enormous difficulties in turning out presentable noises. I would imagine that actual demonstration on the stands would give the public an opportunity of hearing for themselves the difference between the various sets offered; if exhibitors were rigidly tied down to receiving and reproducing only, say, the Regional programme, at not more than 5 watts output, we would soon be able to separate the grain from the chaff. Were such an obviously sensible arrangement put into force, I can well imagine the howls of protest that would go up from the less capable manufacturers, but it would be a good thing for technique, and that is all that concerns me.

A bright show, a pretty show and, in all probability, a selling show, but rather a disappointment for the student of quality reception. I think I will leave it at that.

The Radio Industry

AMONG the latest productions of the Ever Ready Co. are two special H.T. batteries for sets including Class "B" amplification. Type No. W.1210 is rated at 135 volts plus 18 volts for grid bias purposes, and tappings are arranged in accordance with suggestions recently put forward in *The Wireless World*.

It is understood that Scotland Yard and other police authorities are already using, in their wirelessly equipped vehicles, a new type

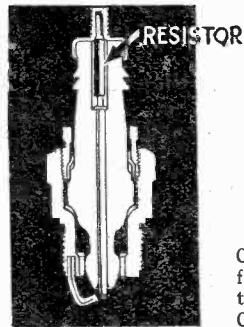

of Champion sparking plug, in which the necessary interference-suppressing apparatus is built into the body of the plug, and connected in series with the central electrode. Various

Complete with interference suppressor: section through the new Champion sparking plug.

types of plug, to suit different engines, are available with this special feature.

Valves for the current season are fully described in the latest edition of the Mullard Valve Guide for 1933-4. This 88-page booklet

is full of technical information, and, apart from data relating purely to valves, a number of circuit diagrams are given, together with advice on the best operating conditions for the latest types. Copies are available for readers.

Tungram have just introduced an equivalent of the American R.C.A., Type 88, full-wave mercury-vapour rectifier. It is rated for an A.C. input of 500 volts to each anode, and for a continuous D.C. output of 125 mA.

Changes of address: the Leeds branch of Siemens Electric Lamps and Supplies, Ltd., is shortly to be moved from 129, Park Lane, to 54, Wellington Street, Leeds, 1. The new telephone number will be Leeds 27395.

The Automatic Radio Gramophone Co., Ltd., notify us that their new address is: Crown Street Hall, Brighton.

Spare parts for "Standard" wet H.T. batteries, which are no longer to be obtained from the original manufacturers, are now being produced by the Wet H.T. Battery Co., of 26, Lisle Street, London, W.C.2.

Mr. T. W. Small, inventor of the well-known "Caphart" record changer, is now in London, staying at the Carlton Hotel. He would welcome a visit from British manufacturers who might be interested in the production of his new fully automatic record changer, operating without the use of gears, chains or sprockets.



September 1st to September 9th

IN last week's issue, the third of our special Olympia Show numbers, we dealt in some detail with the exhibits of interest on the stands of every manufacturer. Now the Show moves on to Glasgow, and to-day, September 1st, the Scottish Radio Exhibition opens at

Kelvin Hall, closing on September 9th. Nearly all the standholders at the Kelvin Hall were also exhibitors at Olympia, so that our Olympia stand-to-stand report of last week may also be taken as a guide to the Scottish Exhibition, a plan of which is included on this page.

Full List of Exhibitors

Local addresses of firms are given in some instances

EXHIBITOR.	STAND.	EXHIBITOR.	STAND.	EXHIBITOR.	STAND.	EXHIBITOR.	STAND.
Amalgamated Press, Ltd. ... Fleetway House, Farringdon St., London, E.C.4.	26	Columbia Graphophone Co., Ltd. ... 98, Clerkenwell Rd., London, E.C.1.	33A	Hustler, Simpson & Webb, Ltd. ... 317, Hoe St., Walthamstow, London, E.17.	12	Radio Gramophone Development Co., Ltd. ... 18-20, Frederick St., Birmingham.	13
Balcombe, Ltd., A.J. ... 52-58, Tabernacle St., London, E.C.2.	29	Cossor, Ltd., A.C. ... 21, Waterloo St., Glasgow.	31	Hutchison, E. W. ... 496, Crow Rd., Jordanhill, Glasgow, W.2.	58	Radio Instruments, Ltd. ... 121, West Campbell St., Glasgow.	63
Ballantine, Robert ... 103 1/2, St. Vincent St., Glasgow, C.2.	65	Cuthbertson & Co., Ltd. ... 11, West Nile St., Glasgow, C.1.	66	Igranie Electric Co., Ltd. ... 50, Wellington St., Glasgow.	23	Robertson, James ... 95, West Nile St., Glasgow, C.1.	22
Belling & Lee, Ltd. ... Cambridge Arterial Rd., Enfield, Middlesex.	56	Denholm, J. Stuart ... 32, Kilmarnock Rd., Glasgow.	49	Jilife & Sons Ltd. ... Dorset House, Stamford St., London, S.E.1.	52	Ross & Adam, ... 68, Gordon St., Glasgow.	73
Bernard Jones Publications, Ltd. ... 58, Fetter Lane, London, E.C.4.	62	Dulcetto-Polyphon, Ltd. ... 2-3, New man St., London, W.1.	7	Itonia, Ltd. ... 58, City Rd., London, E.C.1.	39	Scottish Radio Retailers' Association ... 156, St. Vincent St., Glasgow, C.2.	59
Biggar, Ltd., Alexander ... 102, Sauchiehall St., Glasgow, C.2.	18	Econasign Co., Ltd. ... 92 Victoria St., London, S.W.1.	2	Johnson Talking Machine Co., Ltd. ... 96, Clerkenwell Rd., London, E.C.1.	51	Siemens Electric Lamps & Supplies, Ltd. ... 25, Cadogan St., Glasgow.	11
Black, Ltd., Michael ... 80, Blythswood St., Glasgow, C.2.	28	Edinburgh Rubber Co ... 182, Rose St., Edinburgh.	8	McMichael Radio, Ltd. ... Wexham Rd., Slough, Bucks.	27	Thompson, Diamond & Butcher, ... 34, Farringdon Rd., London, E.C.1.	55
Blackadder, William ... 101, Union St., Glasgow, C.1.	60	Edison Swan Electric Co., Ltd. ... 153, West George St., Glasgow, C.2.	37	Machell & Sons, Thomas ... 45, Gt. Western Rd., Glasgow.	43	Thomson & Brown Bros., Ltd. ... 65, Mitchell St., Glasgow.	53
Block Batteries, Ltd. ... Abbey Rd., Barking, Essex.	67	Epoch Radio Mfg. Co., Ltd. ... Exmouth House, Exmouth St., London, E.C.1.	61	Marcophonphone Co., Ltd. ... 10, West Campbell St., Glasgow.	35	Turner, James ... 2340-2344, Dumbarton Road, Yoker, Glasgow.	20
Britannia Batteries, Ltd. ... 233, Shaftesbury Ave., London, W.C.2.	69	Ever Ready Co. (G.B.), Ltd. ... Hercules Place, Holloway, London, N.7.	30	Muir & Bryden, ... Dumbreck Rd., Glasgow, S.1.	57	Ultra Electric, Ltd. ... Erskine Rd., London, N.W.3.	42
British Blue Spot, Ltd. ... 37-39, Clyde Place, Glasgow.	4	Ewing & McIntosh. ... 425-7, Sauchiehall St., Glasgow, C.2.	1	Mullard Wireless Service Co., Ltd. ... 56, Bothwell St., Glasgow.	36	Varley (Oliver Pell Control, Ltd.) ... 11, Bothwell St., Glasgow.	25
British Broadcasting Corporation ... Broadcasting House, London, W.1.	74	Ensign, Ltd. ... 70-78, York St., Glasgow	47	Murdoch, McKillop & Co., Ltd. ... 101, Hope St., Glasgow, C.2.	21	Westinghouse Brake & Saxby Signal Co., Ltd. ... 82, York Rd., King's Cross, London, N.1.	6
British Rola Co., Ltd. ... Minerva Rd., Park Royal, London, N.W.10.	19	Ferranti, Ltd. ... Hollinwood, Lancashire.	38	Newnes, Ltd., George ... 8-11, Southampton St., London, W.C.2.	17	Whiteford & Co., James ... 5, Oswald St., Glasgow, C.1.	9
"Broadcaster" ... Long Acre, London, W.C.2.	51	Forbes Bros., Ltd. ... 50, Sauchiehall St., Glasgow, C.2.	71	North British Machine Co., Ltd. ... 200, Clyde St., Glasgow, C.1.	16	Whiteley Electrical Radio Co., Ltd. ... Victoria St., Mansfield, Notts.	70
Brown & Co. (Simplex), Ltd. ... 116, West Nile St., Glasgow, C.1.	24	General Electric Co., Ltd. ... Magnet House, 71, Waterloo St., Glasgow.	34	Partridge, Wilson & Co. ... 200, St. Vincent St., Glasgow, C.2.	14	Wireless & Gramophone Trader ... Dorset House, Stamford St., London, S.E.1.	3
Bulgin & Co., Ltd., A. F. ... Abbey Rd., Barking, Essex.	72	Gramophone Co., Ltd. ... 98, Clerkenwell Rd., London, E.C.1.	33	Paterson, Sons & Co., Ltd. ... 114-152, Buchanan St., Glasgow.	46	Wireless World ...	52
Clarke & Co. (M/c), Ltd., H. ... 21, Oswald St., Glasgow.	44	Harper & Co., William ... 93, Holm St., Glasgow.	40	Philips Lamps, Ltd. ... 6-8, Cadogan St., Glasgow.	43	Woolfson, Ltd., Philip ... 165, Trongate, Glasgow.	50
Cohen, S. W. ... 7-15, King St., Glasgow, C.1.	15	Hellesens, Ltd. ... Morden Rd., S. Wimbledon, London, S.W.19.	45	Portadyne Radio, Ltd. ... Portadyne Works, Gorst Rd., London, N.W.10.	64	Wylie, Hill & Co., Ltd., R. ... 20, Buchanan St., Glasgow.	5
Cole, Ltd., E. K. ... Ekco Works, Southend-on-Sea, Essex.	32	Hunter, James R. ... 42, West Nile St., Glasgow, C.1.	10	Pye Radio, Ltd. ... Africa House, Kingsway, London, W.C.2.	41	Young's (Glasgow), Ltd. ... 40, Stockwell St., Glasgow, C.1.	63

Broadcast Brevities

By Our Special Correspondent

A New "Music Hall" ?

I AM able to reveal that the B.B.C. is conducting negotiations for acquiring an old skating rink in Maida Vale and transforming it into a dazzling "Music Hall." Here, in a vast and lofty building covering an area of 58,000 square feet, the Corporation will run a restaurant, green rooms for artistes, and several minor studios in addition to the large hall from which vaudeville and variety will be broadcast free from the restrictions attaching to Broadcasting House.

Secret Negotiations

Up to the moment of writing the utmost secrecy has been observed in connection with these arrangements, although it has long been apparent to informed onlookers that the B.B.C. was straining at the leash in regard to studio accommodation. The B.B.C. tenure of "No. 10," the famous wharf studio, is exceedingly precarious as the L.C.C. has the power to take over the building at very short notice, and may exercise its prerogative; yet the wharf is the B.B.C.'s only real large studio, apart from the Concert Hall at Broadcasting House, which is admittedly too small to accommodate the National Orchestra.

Space for 250 Singers

At Maida Vale it should be possible to rehearse the entire orchestra of 117 players as well as the National Chorus of 250 voices.

Until recently the hall was used as offices for the Ministry of Health.

The Big Three

THIS morning at 10 o'clock Colonel Dawnay enters upon his duties as Director of the B.B.C.'s Output Department. Structural alterations have already been effected at Broadcasting House to enable the new Director to keep in close touch with the Director-General and the Controller.

Sir John Reith for America

The party is likely to be broken up for a little while in the near future when Sir John Reith responds to the invitation of Mr. Aylesworth, President of the National Broadcasting Company of America, to attend the opening of "Radio City," the great new centre of entertainment between Fifth and Sixth Avenues, New York.

Strange . . .

Sir John will probably be included among the speakers, and as the ceremony will be broadcast and relayed across the Atlantic, British listeners will have one of those rare opportunities of hearing the "D.G." on the ether. Strange that Sir John should cross the Atlantic to speak to his own flock, but this is a strange world, as the boxer said when he "came to" in the television studio.

The Boxing Match

Which reminds me that the boxing match in Studio Eb last week made a good showing on the television screen although the figures were rather small.



WHERE IS IT? The mystery building in West London which, according to our Special Correspondent, the B.B.C. hopes to transform into a "Music Hall" for vaudeville shows as well as choral and orchestral concerts.

Problem for Television Talkers

I learnt one thing on that occasion, namely, that the television talker requires a technique rather different from that of the ordinary broadcast speaker closeted in a talks studio. There is nothing more irritating than a close-up of an immovable face continuing for ten minutes!

How our profound but undemonstrative speakers will get over the difficulty I know not, but I am convinced that plastic features and sparkling eyes are a necessity.

Electric Piano Broadcast

IT was delightful to hear the Neo-Bechstein piano broadcast on Saturday last, and gratifying to reflect that the innovation was the outcome of a suggestion first made in these columns.

The instrument gives most puzzling effects. Sometimes one detects the authentic pianoforte tone but more often the impression is of an orchestral combination with organ background.

Bedtime Stories

FOR a long time there has been a bathroom in Broadcasting House. Now there is a bedroom, which has been placed at the disposal of Empire announcers for use between their spells of night duty.

I understand, however, that the occupants will not make their announcements from the bedside, although several of the tribe at Broadcasting House would be quite capable of announcing in their sleep. In fact, they often do.

Mr. Stanley Baldwin

TWELVE talks under the general title, "National Character," will be broadcast during the autumn. On September 25th, Mr. Stanley Baldwin, M.P., will introduce the series in a twenty-minutes' broadcast on the National wavelength.

The subject is one very much after Mr. Baldwin's heart; for the series will attempt to describe the salient features of the British character both in its strength and weakness. An interesting aspect of the series will be the introduction of a foreigner at the microphone, to tell listeners about various aspects of our national character as they appear to him.

Hitler Relay Declined by B.B.C.

THE publication in a B.B.C. journal of sympathetic remarks concerning the German broadcasting chiefs who have been sent to the Oranienberg Internment Camp, brought an unexpected offer from the Reich Rundfunk Gesellschaft of a special relay from the Camp.

Apparently the intention was that British listeners should have an opportunity of hearing a first-hand account of the happy and orderly conditions obtaining in the Camp. The item was offered to the B.B.C. for Tuesday evening, August 22nd, but the B.B.C. declined the honour. It is significant that the relay, which would have been broadcast throughout Germany at the same time, was cancelled.

They Dreamt They Dwelt . . .

IT is scurvy treatment for the B.B.C. Publications Department to be harried from pillar to post, seeing that it is from the activities of this branch that the Corporation derives a goodly percentage of its income.

. . . in Marble Halls

Nevertheless, it is the Publications which have had to move into that old chateau, No. 16, Portland Place, which in the last week or two has been transformed into a modern office. It was the Publications Department which was farmed out in Southampton Street, Strand, in the old Savoy Hill days, so it is natural, I suppose, that they should be the first to leave the crowded pleasure dome in Portland Place.

Cause and Effect

A FRIEND of mine was not surprised to read last week of the decision to transfer "Nine Days' Wonder" from Olympia to the Palladium. He was attending the revue, and was actually seated near to Mr. George Black, of the General Theatres Corporation. Half-way through the show, when the audience was rocking with laughter, a loud voice was heard to say, "My word! This would make George Black sweat if he heard it!"

A few minutes later George Black was hurrying towards the stage door to interview Mr. Maschwitz, and the sequel was made public next morning.

Correspondence

The Editor does not hold himself responsible for the opinions of his correspondents.

Correspondence should be addressed to the Editor, "The Wireless World," Dorset House, Stamford Street, S.E.1, and must be accompanied by the writer's name and address.

Valves or Stages

WITH reference to the suggested new designation for receiving sets given in your issue for August 4th, we should like to express the opinion that the suggested idea of describing a set by its stages is likely to lead not only to a very great deal of confusion but also to open up the path for misrepresentation.

As an indication of the confusion that is likely to arise, it would appear to us that, working to the suggested definition given in your leader, the Ferranti "Gloria" Console, described on pages 78 and 79 of the same issue, is actually a seven-stage receiver and not a six-stage as described by you, seeing that in the second detector there are three anode-to-cathode electron streams.

When the Ferranti Company first placed its receivers on the market, it described its three-valve mains receiver plus a rectifier as a three-valve set, and, as the result of considerable experience, it was found that this led to endless confusion, bearing in mind that the people who buy sets in general know next to nothing about them.

Further, the standard practice in the case of American receivers, was to include the rectifier as a valve, and such competition has had to be met in a suitable way.

We have always made it very clear in our specification as to the purpose of each individual valve, but we think that it is utterly absurd for manufacturers to be placed in the position of having to tell the man in the street that certain of the valves in their receivers are valves, whilst the rectifying valve, which is probably more correctly a valve than any of the others, is not a valve.

It appears probable that to describe a set by the number of its valves or by the number of its stages is likely to be very misleading in any case, and does not, in these days, necessarily give any indication of the performance of the receiver, so for this reason Ferranti, Ltd., have this year gone still farther than any of the foregoing proposals, and do not in any of their descriptions call their sets by the number of valves that they contain, although this may be found from the technical data included in the literature concerning the sets in question.

FERRANTI, LTD.

J. BAGGS, Sales Department Publicity.

The Correct Application of A.V.C.

MAY I be permitted to express some views on the application of A.V.C. to receivers in this country in view of the recent correspondence on this subject?

Firstly, I am entirely in agreement with Mr. Redfern that A.V.C. is undoubtedly desirable in the serious listener's receiver, but only when that receiver has been designed as a whole to incorporate A.V.C. and to overcome its associated disadvantages (such as those enumerated in Mr. Haynes' letter). Apart from the valuable correction of fading, an inexperienced person can leave the volume control set and tune in station after station without getting on the nerves of other people present by

making a series of blasts and over-loading the output valve. Perhaps I had better use the word "almost," because automatic volume control, *i.e.*, automatic levelling up of the volume delivered by the loud-speaker on all stations, will never be possible unless broadcasting stations come to some agreement as to the minimum and maximum modulation limits desirable. At present the difference in modulation levels is only too evident when operating an A.V.C. receiver with a milliammeter in the anode circuit of one of the controlled valves. Actually, the function which we loosely call "A.V.C." is concerned only with the carrier amplitude and not the modulation depth, so that two stations whose field strengths are equal at the aerial may produce average volume levels at the loud speaker in the ratio of about 2 to 1. This is annoying, but cannot be helped. However, the manual volume control is a convenient compensator.

The strongest criticism against A.V.C. is the apparent loss of selectivity. When tuning from one to another of two adjacent stations with a good A.V.C. receiver the

side bands are so enormously amplified by the A.V.C. action that there is no silent gap between the two stations. Because of this effect, A.V.C. is entirely unsuitable for inclusion in simple sets with few or flatly tuned circuits where the resonance curve of the tuned circuit does not fall away very steeply at the sides. Although this reduction of selectivity is stated to be apparent only, nevertheless the selectivity of the receiver as a whole is definitely reduced if it cannot, with A.V.C., receive as many stations free of interference as it can without.

The criticisms on the score of background mush have been adequately dealt with by Mr. Redfern, but it does not appear to be generally realised that, apart from quiet A.V.C., which is a luxury only likely to be found in highly priced instruments, it is quite a simple matter to suppress this interference as well as all other between-station noises.

If the receiver be fitted with a device giving visual indication when the set is in resonance with the wanted station, why then we can short out all the undesirable noises between stations with a silencing switch and tune in our station quietly and accurately, the switch being opened only when the station has been correctly tuned in; so that instead of the quality varying from a high-pitched cacophony gradually down to the natural tone, the natural tone is there immediately the station is heard. This meets most of the criticisms fired at A.V.C., and works delightfully in practice, particularly when signals can be faintly heard in the "silent" position, so that the operator can tell whether the programme is desirable before inflicting it on other listeners.

As regards atmospheric interference it is difficult to be certain whether or not A.V.C. is beneficial, and one must not make wild claims. It has been found possible, during the recent thundery conditions in London to receive the London Regional on an A.V.C. set with a 100-foot aerial with scarcely any interference, although distant stations were unintelligible through mush and crashes. This is due to the receiver being rendered so insensitive by the strong carrier of the local station that no appreciable amplification is given to the static picked up by the aerial.

There seems to be no justification in practice for contrasting the two systems of simple and delayed A.V.C., for when the former is correctly applied the "throttling effect" is quite negligible on a weak signal. It has been found possible to make a six-valve A.C. superhet. with loose H.F. and I.F. couplings for selectivity and a diode-tetrode for A.V.C. with no delay action, which has an absolute sensitivity of 2.5 microvolts over the tuning range, *i.e.*, to produce the standard output of 50 milliwatts. This is considerably better than some receivers using the same number of stages and delayed A.V.C.

Per pro ELDECO RADIO, LTD.,
R. C. RICKARD.

London, W.I.

ON WHAT AUTHORITY?

HERE is a reproduction of a notice to consumers typical of many issued by electricity supply authorities. They probably believe themselves that they are justified in insisting that wireless sets should be connected to the lighting circuit; otherwise

MEXBOROUGH URBAN DISTRICT COUNCIL.

ELECTRICITY DEPARTMENT

NOTICE.

Consumers are reminded that Wireless Sets must not be used on a Heating circuit, and the employees of this Department have instructions to disconnect any apparatus which contravenes the regulations in this way.

J. B. FELTHAM, M. Inst.E.E.
Engineer and Manager.

they would surely not have the audacity to issue such notices.

We believe that the lighting rate can only be exacted where electricity is used for purposes of illumination, and we have already offered space in our correspondence columns to any supply authority which cares to argue the point.

READERS' PROBLEMS

THESE columns are reserved for the publication of matter of general interest arising out of problems submitted by our readers. Readers requiring an individual reply to their technical questions by post are referred to "The Wireless World" Information Bureau, of which brief particulars, with the fee charged, are to be found at the foot of this page.

I.F. Transformer Tuning

WHILE operating his superheterodyne receiver (modelled on the original Monodial), a correspondent has noticed that signal strength is appreciably increased by removing the screening cover of one of the I.F. transformers; he asks us to say what may be deduced from this experience.

It would appear probable that the transformer in question is tuned to too high a frequency. The effect of removing the cover is to increase the inductance of the coils and so to lower the resonant frequency. It is quite possible that, by this alteration, the out-of-tune circuit is accidentally brought into line with the others.

A Process of Elimination

THE circuit adopted by a reader for his four-valve battery set might have been chosen for no other purpose than to illustrate the principles of fault finding by a process of elimination! Similarly, the fault that exists provides a particularly good example of how a logical line of reasoning may be applied.

In Fig. 1 is reproduced in skeleton form the part of the receiver in question. The fault takes the form of an almost continuous rustling or "frying" noise, evident while the set is being operated as a radio receiver, but entirely absent on switching the pick-up into circuit. Removal of the H.F. valve does not lessen the noise, although, of course, it prevents the reception of signals.

As the pick-up is connected to the grid circuit of the first L.F. amplifier, it can be assumed quite definitely that from this point onwards no fault can exist, and, further, that the batteries, etc., which are common to all valves, are in order. Again, the fact

"frying" noise is often due to the leakage of high-tension current through a path of fairly high, but changing, resistance.

Anti-Interference Aerials

SEVERAL questions have lately been received from sufferers from man-made static on the question of fitting screened aerial down-leads as a palliative. Articles which appeared in the issue of August 18th will have already provided the answer to most of these questions, but there are one or two other points that might be cleared up.

A screened aerial down-lead can do nothing to reduce interference of the type that affects all parts of the aerial more or less equally. For instance, strong radiation from an overhead tramway line will be found almost always to come within this category. The same applies to overhead power wires, which will probably affect the horizontal part of the aerial just as much as the down-lead.

Little benefit is likely to accrue from fitting a shielded down-lead unless a good part of the aerial can be erected well clear of the source of interference.

Before going to the trouble of altering the aerial, it is a good plan to try the effect of fitting a simple filter in the supply leads of a mains-operated set. A large proportion of the interference may be reaching the receiver in this way.

From the L.F. Point of View

THERE is nothing basically wrong with tuned anode H.F. coupling, but nevertheless it has rather gone out of fashion during the last year or two. Probably the most serious objection that can be urged against this system is that it allows L.F. impulses to be fed back directly to the

circuit of the H.F. valve, a suitable decoupling system. The values of the decoupling components must be effective both at H.F. and L.F.; the usual 1,000 ohms and 0.1 mfd. is almost useless.

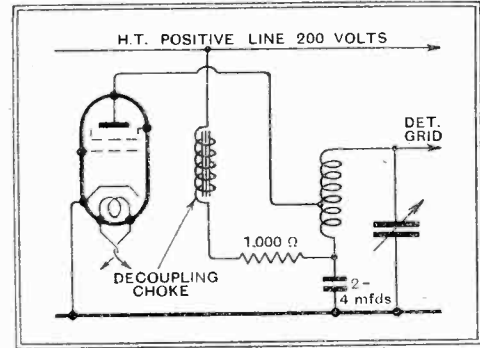

Fig. 2.—Reducing voltage loss: decoupling for a tuned-anode H.F. stage.

A reader who has constructed an H.F.-det.-2 L.F. set with a tuned anode H.F. coupling finds that motor-boating can only be prevented by inserting such a large value of decoupling resistance that the sensitivity of the H.F. stage is seriously impaired.

In asking our advice, he says nothing about the capacity of the associated bypass condenser; if he has not tried a large capacity (from 2 to 4 mfd.) we recommend him to do so. If this course fails, we suggest the use of a high-inductance choke as a decoupling device in the manner shown in Fig. 2; this should give good L.F. decoupling without undue loss of H.T. voltage.

As there is a faint possibility that this choke may be ineffective as an H.F. decoupling device, the existing 1,000-ohm resistance might be left in circuit, as indicated in the diagram.

As You Were

THE practice of fitting "noise suppressors" in sets with A.V.C. seems to have given rise to a misconception as to the "background noisiness" of sets with this form of control.

For instance, a correspondent, who is undecided as to whether to fit automatic volume control, appears to think that this addition to his set will result in a noisier

The Wireless World

INFORMATION BUREAU

THE service is intended primarily for readers meeting with difficulties in the construction, adjustment, operation, or maintenance of wireless receivers described in *The Wireless World*, or those of commercial design which from time to time are reviewed in the pages of *The Wireless World*. Every endeavour will be made to deal with queries on all wireless matters, provided that they are of such a nature that they can be dealt with satisfactorily in a letter.

Communications should be addressed to *The Wireless World* Information Bureau, Dorset House, Stamford Street, London, S.E.1, and must be accompanied by a remittance of 5s. to cover the cost of the service. The enquirer's name and address should be written in block letters at the top of all communications.

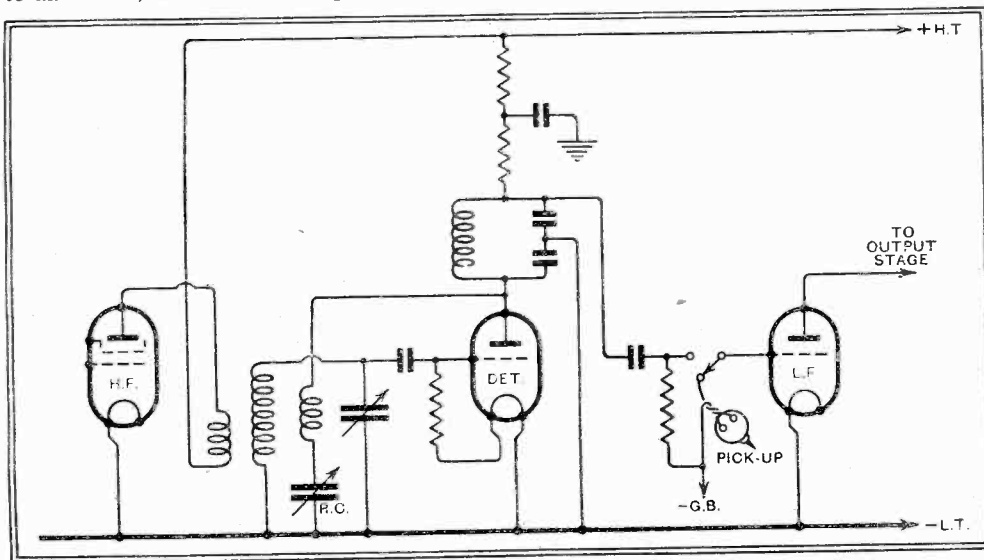

Fig. 1.—A simplified circuit diagram to illustrate the tracing of faults by a process of elimination.

that removal of the H.F. valve makes no difference indicates that the fault cannot lie in this valve or in the circuits preceding it.

All that remains, therefore, is the detector valve, and here, or in the associated circuits, the defect is certain to be found. A

detector grid from the source of H.T. supply, and thus L.F. oscillation or motor-boating may be provoked.

Short of employing some other form of H.F. coupling, the only way to prevent this kind of feed-back is to employ, in the anode

LABORATORY TESTS

A Review of Manufacturers' New Products

back-ground than previously, and that a suppressor will be virtually necessary.

This is a mistake. Automatic volume control does nothing whatever to increase background noises, but it does rather tend to make these noises more evident. This is because the set, when tuned to a powerful carrier wave is automatically desensitised, and if the ratio of signal-to-noise is favourable the background will appear to be quiet.

Noise suppression in A.V.C. sets is a luxury and a desirable refinement, but it is by no means a necessity.

Building the New Monodial

IT is perhaps as well to point out that, in assembling the new Monodial Super, it is necessary that the ganged tuning condenser should be raised above the baseboard by interposing the distance pieces (or spacing tubes) supplied with the condenser. Otherwise the height of the spindle will be found unsuitable for the special dial which was used in the original model.

NEW MAINS-OPERATED AUDIO-FREQUENCY OSCILLATOR

DESIGNED especially for laboratory use, the new A.C. mains-operated audio-frequency oscillator introduced by Standard Telephones and Cables, Ltd., Connaught House, Aldwych, London, W.C.2,



Mains-operated audio-frequency oscillator, a Standard Telephones product.

covers a range of 20 to 10,000 c/s in a number of graduated steps. The circuit consists of three valves, an oscillator, an amplifier, and a mains rectifier for H.T. supply, and provision is made for checking the frequency on controlled 50 c/s supply mains.

The output has a very small harmonic content, hum level is low, and the frequency stability is within ± 0.2 per cent. throughout.

The construction follows conventional wireless practice, for all components are mounted on a stout metal chassis and housed in a strong oak cabinet fitted with a carrying handle, the price is £42.

A thermo-ammeter set and an attenuator are available; the former costs £12 10s. complete, while the price of the latter is £15.

This instrument will serve for test and measurements on L.F. amplifying equipment, L.F. components, as well as for inductance and capacity bridge work.

GRAHAM FARISH LIGHTNING GARD

AT this season there is always the possibility that an outdoor aerial may be struck by lightning. Admittedly the risk

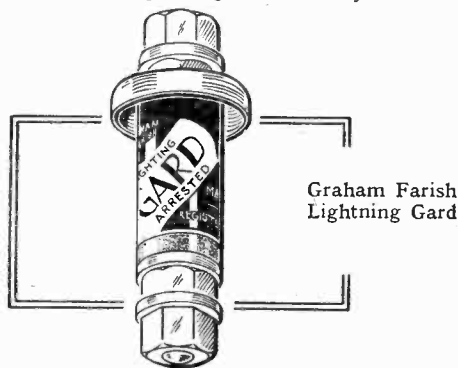

Graham Farish
Lightning Gard

is small, but as adequate safety devices are now obtainable at small cost it is hardly worth while exposing the receiver to this danger, for far more serious consequences than a damaged set may result.

The Graham Farish Lightning Gard has been designed to afford protection in such cases, and it consists of an insulated barrel into each end of which is screwed a brass stud. These are separated by a thin annular washer. The device must, of course, be located outside the building so that a direct path to earth is available.

The aerial down lead and the lead to the aerial terminal of the set join to the top terminal on the Gard, while the lower terminal is joined direct to an earth connection. The earth wire from the set can be taken either to the same earthing point or to any other that may be convenient inside the building.

The device in no way affects reception, but in the event of the aerial being struck by lightning the charge ionises the small spark gap and passes direct to earth.

The price is 1s. 6d., and the makers are Graham Farish, Ltd., Masons Hill, Bromley, Kent.

PREH SEVEN-PIN VALVE HOLDER

A SEVEN-PIN valve holder for chassis mounting, and suitable for use with Class "B" output valves, has been introduced by the Preh Manufacturing Co., Ltd., 13-15, Broadwater Road, Welwyn Garden City, Herts. The sockets are made from phosphor-bronze strip, bent and shaped to form a resilient contact for the pins. These are assembled on a moulded bakelite base.

Several different makes of Class "B" valves were inserted in the holder, and in

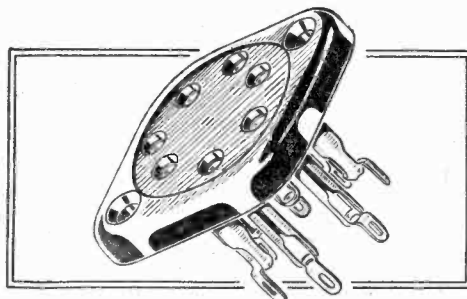

Preh seven-pin valve holder suitable for Class "B" output valves.

every case a perfectly satisfactory contact was made between the valve pins and their respective sockets. Although rigidly fixed to the base plate, the sockets possess sufficient resilience to ensure correct alignment in all cases, for the valve slides into its socket quite smoothly and without undue pressure.

Soldering tags, which are part of the socket, are provided, and the price is 1s.

DISTANT RECEPTION NOTES

MONTE CENERI has definitely closed down for alterations and will not be at work again until towards the end of September. Kalundborg, therefore, remains clear, and is providing very fine reception at present.

I had thought that the transmission interfering with Huizen on 1,875 metres was Kaunas, but I have now identified it as a Russian station. Interference has been very severe on some recent days.

Last year Mexico, Cuba, the Argentine and a number of other countries in South America brought high-powered transmitters into operation. The range of many of these stations was so great that they were very well heard in this country. A great deal of interference was caused with U.S.A. transmissions and it was decided to call a Pan-American Conference to try to straighten matters out.

That conference is sitting at the present time, and high hopes are entertained that its deliberations will be successful. It is all to the advantage of long-distance listeners in this country that they should, for last winter one not infrequently found Argentine stations jamming those in the U.S.A. and vice versa.

Now that the evenings are drawing in numbers of medium-wave stations are to be received at any time after about 7 p.m., and by eight o'clock even with a smallish set one has as big a selection of alternative programmes as could be desired.

Motala continues to come through well on the long waves. Other good stations between 1,000 and 2,000 metres are Huizen (Hilversum programmes), Radio-Paris, Warsaw and Kalundborg.

Between 200 and 550 metres Prague, the Poste-Parisien, Langenberg, Breslau, Heilsberg, Toulouse, Rome, Strasbourg, Bero-münster, Stockholm, Leipzig and Vienna are nearly always to be found coming in well when required. Stations now returning to form are Brno, Belgrade, Berlin Witzleben, Katowice, Bordeaux, Genoa, Bratislava, Moravska-Ostrava, Hörby, Frankfurt and Gleiwitz.

D. EXER.

Theory of Thermionic Vacuum Tubes, by E. Leon Chaffee, Ph.D. Written primarily as a textbook based on the author's lectures at Harvard University, it comprises a very complete book of reference on matters relating to low-power valves. The author states that a second volume dealing with power amplifiers, rectifiers, etc., is in preparation. Pp. 652 + xxiii., with 362 diagrams and 6 plates. Published by McGraw Hill Publishing Co., Ltd., New York and London. Price 36s.